



The Future of Analog IC Technology®

# EV8843-G-00A

## 6V, 3A, Synchronous, Step-Down Switcher With I<sup>2</sup>C Interface

### DESCRIPTION

The EV8843-G-00A is used for demonstrating the performance of MP8843, a highly integrated, high frequency, synchronous, step-down switcher with I<sup>2</sup>C control interface.

MP8843 supports up to 3A current from a wide input supply range of 2.5V to 6V with excellent load and line regulation. Constant-on-time (COT) control provides fast transient response, high light-load efficiency and easy loop stabilization. The I<sup>2</sup>C interface allows for communication interface speed up to 3.4Mbps. It controls the output voltage on the fly from 0.6V to 1.1V with 3.9mV voltage steps and it also controls the output voltage transition slew rate. The interface also allows for the selection of power-save mode to meet different application requirements. Protection features include internal soft-start, over-current protection, and over-temperature protection. MP8843 is available in 2mmx2mm 12-pin QFN package.

### ELECTRICAL SPECIFICATION

Parameter	Symbol	Value	Units
Input Voltage	V <sub>IN</sub>	2.5—6	V
Output Voltage	V <sub>OUT</sub>	0.6—1.1	V
Output Current	I <sub>OUT</sub>	3	A

#### Notes:

- 1) V<sub>IN</sub><3.3V, may need more input capacitors.
- 2) V<sub>OUT</sub> default value is 0.9031V.

### FEATURES

- Wide 2.5V to 6V Operating Input Range
- Up to 3A Output Current
- 55mΩ and 35mΩ Internal Power MOSFET
- High Speed I<sup>2</sup>C Communication Interface up to 3.4MHz
- I<sup>2</sup>C Selectable Power Saving Mode
- Programmable Output Voltage from 0.6V to 1.1V with 3.9mV Steps
- Programmable Switching Frequency 1MHz to 2.5MHz
- Programmable Voltage Transition Slew Rate
- External and I<sup>2</sup>C-Controlled Power Good Indicator
- Short Circuit Protection with Latch-off
- Thermal Shutdown
- Internal Soft-Start Time
- Available in QFN-12 (2mmx2mm) Package

### APPLICATIONS

- Small/Handheld Devices
- Storage Drives
- Portable Instruments
- Battery-Powered Devices

All MPS parts are lead-free and adhere to the RoHS directive. For MPS green status, please visit MPS website under Quality Assurance. "MPS" and "The Future of Analog IC Technology", are Registered Trademarks of Monolithic Power Systems, Inc.

## EV8843-G-00A EVALUATION BOARD



Board Number	MPS IC Number
EV8843-G-00A	MP8843GG

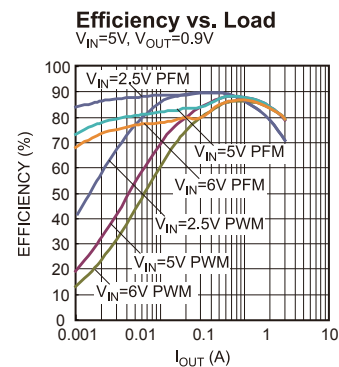

## EVALUATION BOARD SCHEMATIC

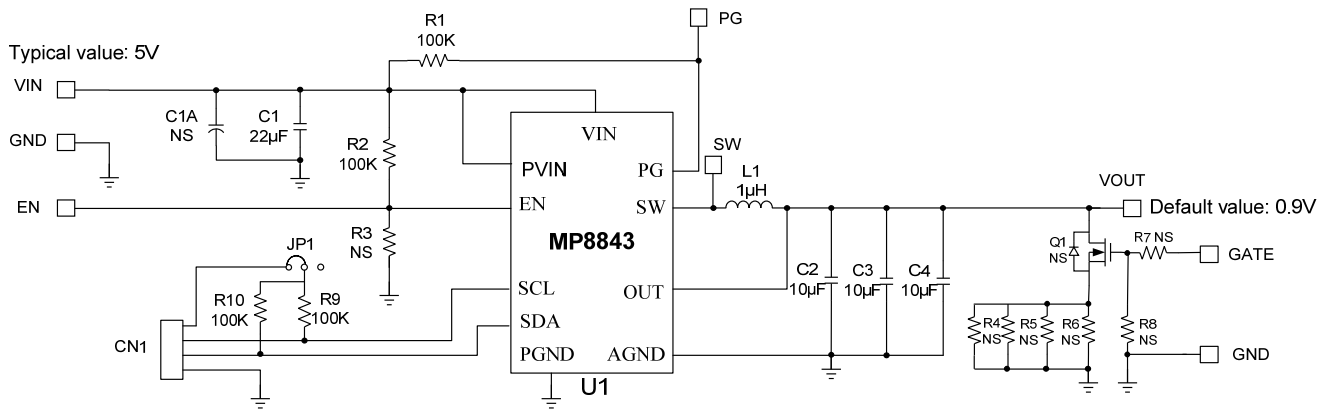
**Notes:**

- 3)  $V_{IN} < 3.3V$ , may need more input capacitors.
- 3)  $V_{OUT}$  default value is 0.9031V.

## EV8843-G-00A BILL OF MATERIALS

Qty	RefDes	Value	Description	Package	Manufacturer	Manufacturer P/N
4	R1, R2, R9, R10	100k	Film Res, 1%	SM0603	ROYAL	RL0603FR-07100KL
0	R3, R4, R5, R6, R7, R8	NS				
0	Q1	NS				
0	C1A	NS				
1	C1	22µF	Ceramic Cap., 10V, X5R	SM0805	Murata	GRM21BR61A226ME51L
3	C2, C3, C4	10µF	Ceramic Cap., 10V, X5R	SM0805	Murata	GRM21BR61A106KE19L
1	L1	1µH	Inductor, DCR=22mΩ, 4.0x4.0mm, Isat=9A	SMD	Würth	74437324010
1	U1	MP8843GG	Synchronous Step-down Converter	QFN12 (2mmx2mm)	MPS	MP8843GG

### EVB TEST RESULTS

Performance waveforms are tested on the evaluation board.

V<sub>IN</sub>=5V, V<sub>OUT</sub>=0.9V, L=1μH, T<sub>A</sub>=25°C, unless otherwise noted.

Efficiency vs. Load

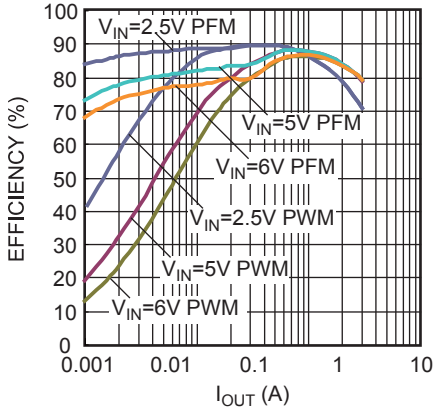

Load Regulation

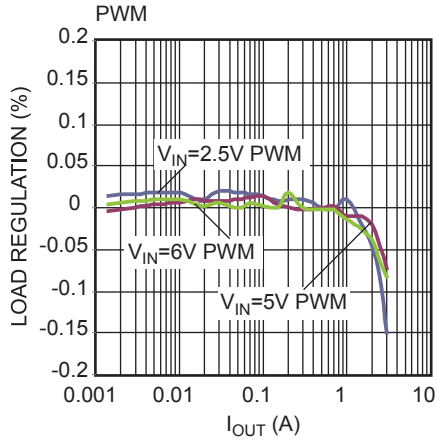

Load Regulation

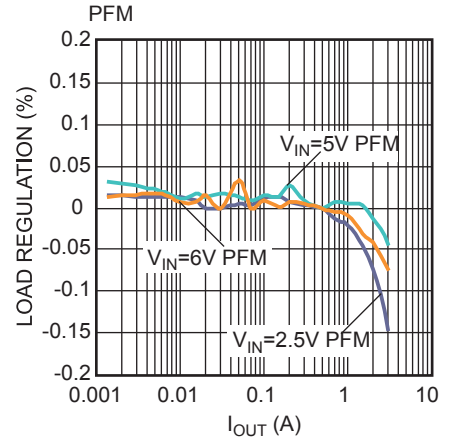

Line Regulation

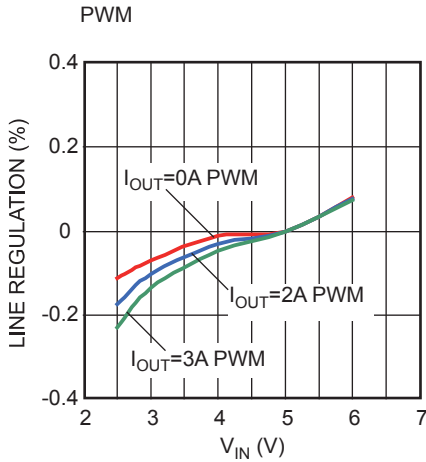

Current Limit vs. Input Voltage

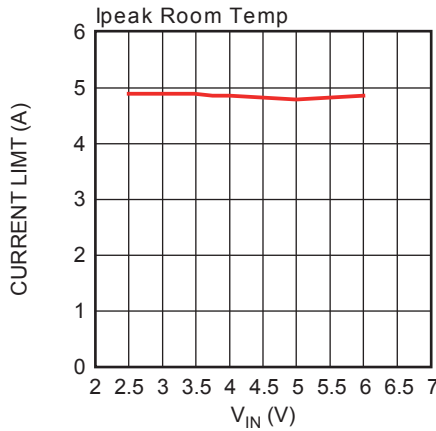

Thermal Rise vs. Load

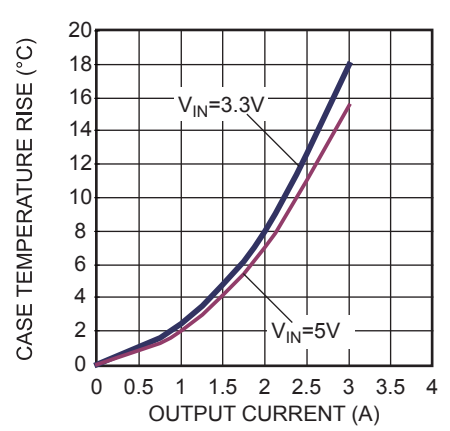

**EVB TEST RESULTS (Continued)**

Performance waveforms are tested on the evaluation board.  
 $V_{IN}=5V$ ,  $V_{OUT}=0.9V$ ,  $L=1\mu H$ ,  $T_A=25^{\circ}C$ , unless otherwise noted.

**Steady State**  
 PWM  $I_{OUT}=0A$

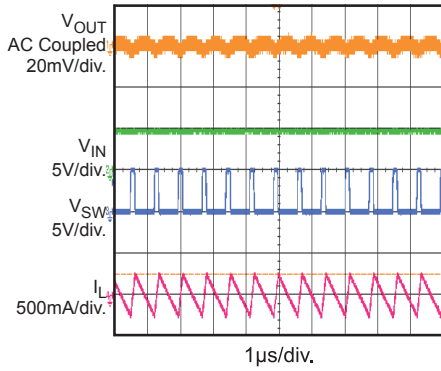

**Steady State**  
 PWM  $I_{OUT}=3A$

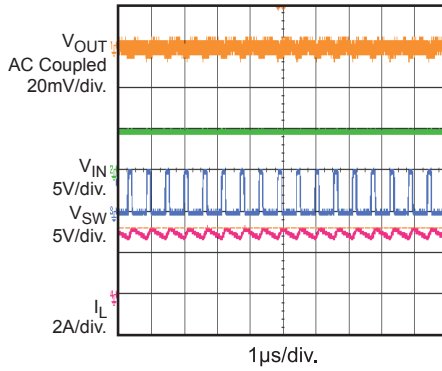

**Steady State**  
 PFM  $I_{OUT}=0A$

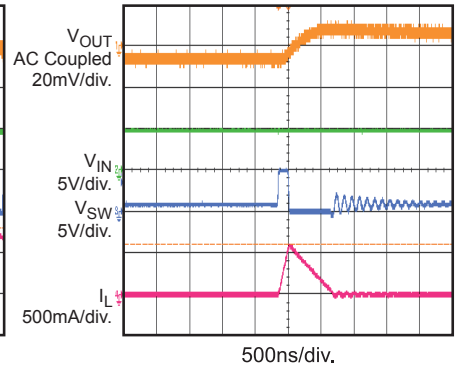

**Vin Startup**  
 PWM  $I_{OUT}=0A$

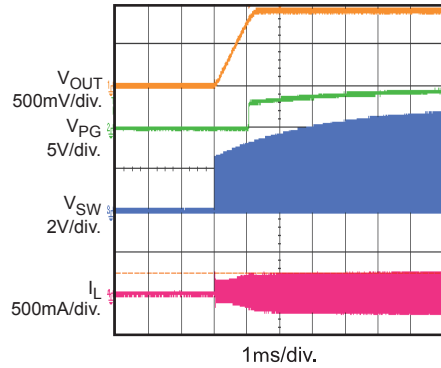

**Vin Startup**  
 PWM  $I_{OUT}=3A$

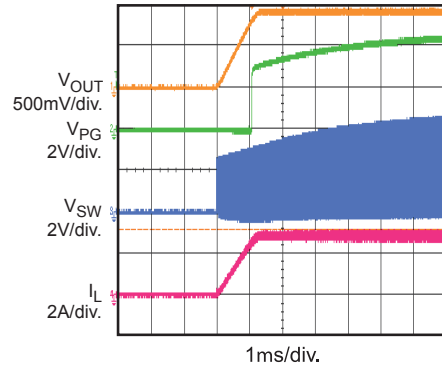

**Vin Shutdown**  
 PWM  $I_{OUT}=0A$

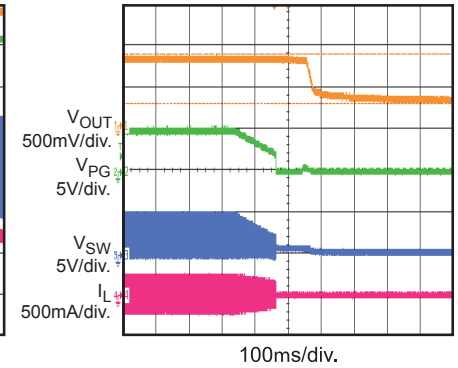

**Vin Shutdown**  
 PWM  $I_{OUT}=3A$

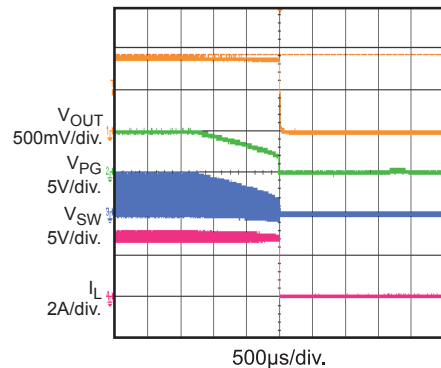

**EN Startup**  
 PWM  $I_{OUT}=0A$

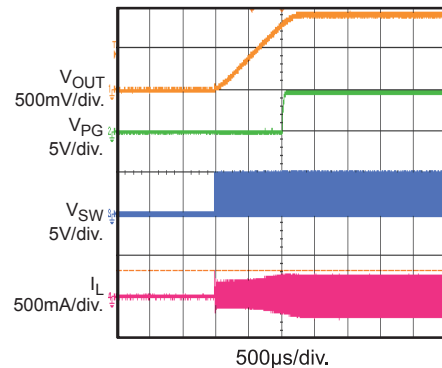

**EN Startup**  
 PWM  $I_{OUT}=3A$

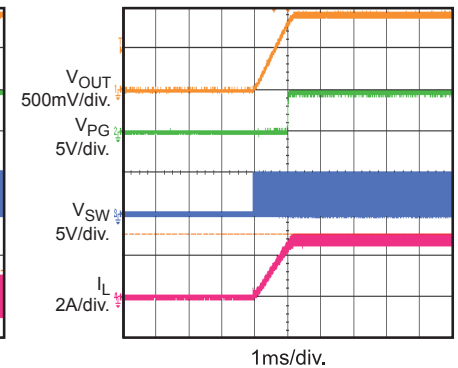

**EVB TEST RESULTS (Continued)**

Performance waveforms are tested on the evaluation board.  
 $V_{IN}=5V$ ,  $V_{OUT}=0.9V$ ,  $L=1\mu H$ ,  $T_A=25^{\circ}C$ , unless otherwise noted.

**EN Shutdown**  
 PWM  $I_{OUT}=0A$

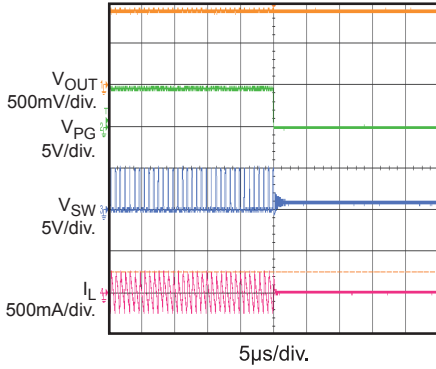

**EN Shutdown**  
 PWM  $I_{OUT}=3A$

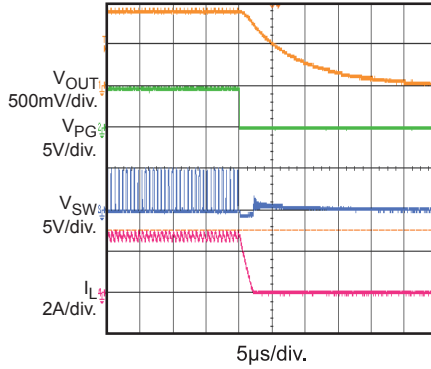

**SCP**  
 PFM

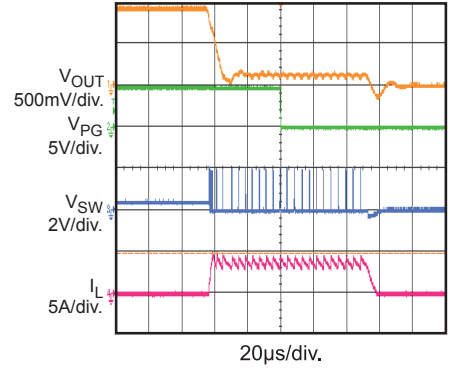

**Load Transient**  
 PFM  $I_{OUT}=0A$  to  $3A$

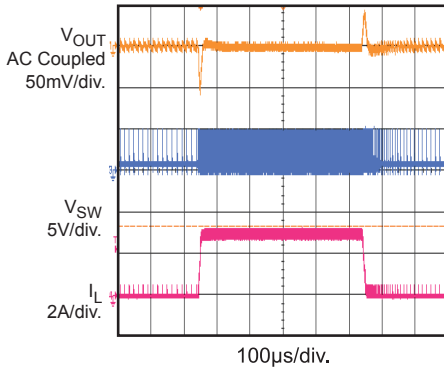

**Load Transient**  
 PWM  $I_{OUT}=0A$  to  $3A$

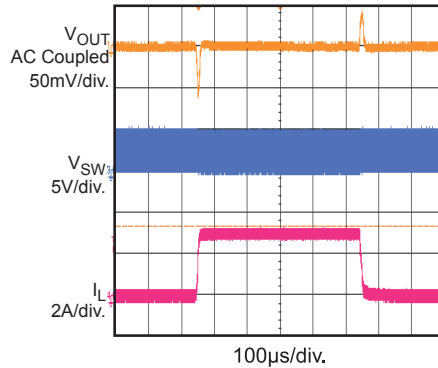

**PRINTED CIRCUIT BOARD LAYOUT**

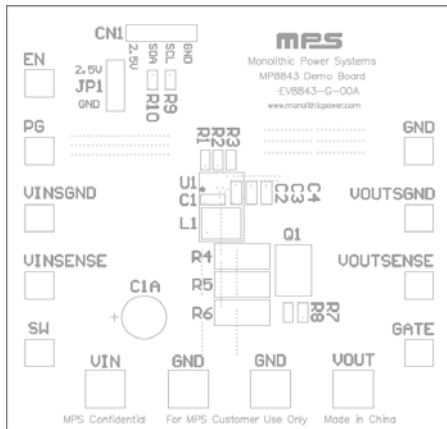

**Figure 1—Top Silk Layer**

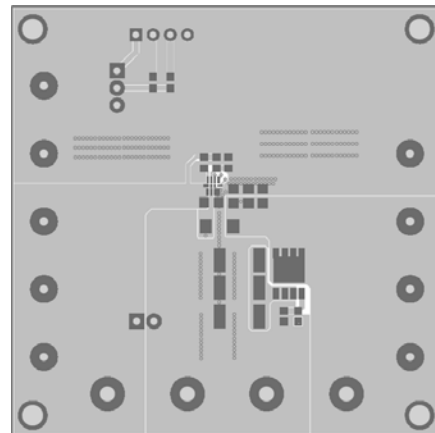

**Figure 2—Top Layer**

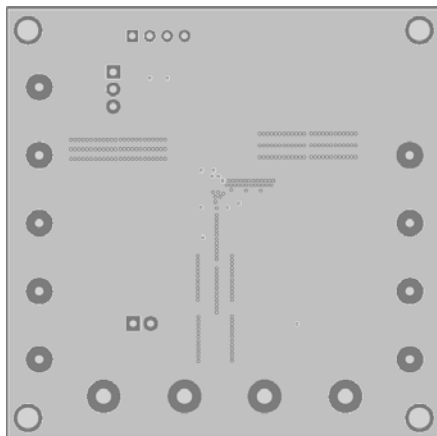

**Figure 3 — Inner Layer1**

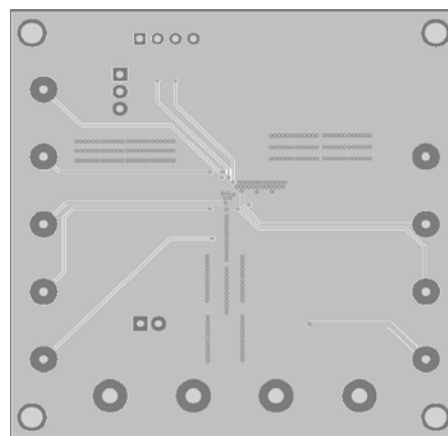

**Figure 4 — Inner Layer2**

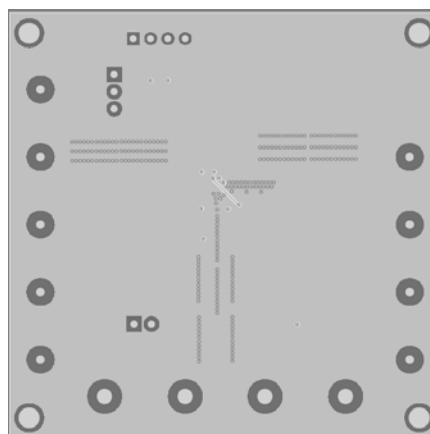

**Figure 5 — Bottom Layer**

## QUICK START GUIDE

1. Connect the positive and negative terminals of the load to the VOUT and GND pins, respectively.
2. Preset the power supply output between 2.5V and 6V, and then turn off the power supply.
3. Connect the positive and negative terminals of the power supply output to the VIN and GND pins, respectively.
4. Turn the power supply on. The board will automatically start up.
5. To use the Enable function, apply a digital input to the EN pin. Drive EN higher than 1.2V to turn on the regulator or less than 0.4V to turn it off.

## LAYOUT RECOMMENDATION OF MP8843

Proper layout of the switching power supplies is very important, and sometimes critical for proper function. Poor layout design can result in poor line or load regulation and stability issues. Please follow these guidelines and take page 6 as reference:

1. The high current paths (GND, VIN and SW) should be placed very close to the device with short, direct and wide traces.
2. The input capacitor needs to be as close as possible to the VIN and GND pins.
3. The Mode/Frequency circuit should be placed closed to the part.
4. The external feedback resistors should be placed next to the FB pin.
5. Keep the switching node SW short and away from the feedback network.

In order to have better performances, it is better to use four layer boards. The inner 1 and 2 layers are Ground.

**NOTICE:** The information in this document is subject to change without notice. Please contact MPS for current specifications. Users should warrant and guarantee that third party Intellectual Property rights are not infringed upon when integrating MPS products into any application. MPS will not assume any legal responsibility for any said applications.