



EV8862-Q-00A

2.8 - 22V V_{IN} , 2A I_{OUT} , 4-Switch, Integrated Buck-Boost Converter with I²C Interface

DESCRIPTION

The EV8862-Q-00A is an evaluation board for MP8862, which is a synchronous, 4-switch, integrated buck-boost converter capable of regulating the output voltage from a 2.8V to 22V wide input voltage range with high efficiency. The integrated output voltage scaling and adjustable output current limit functions meet the USB power delivery (PD) requirement.

The MP8862 uses constant-on-time (COT) control in buck mode and constant-off-time control in boost mode, providing fast load transient response and smooth buck-boost mode transient. The MP8862 provides auto PFM/PWM or forced PWM switching modes, programmable output constant current (CC) current limit, which supports flexible design for different applications.

Full protection features include over-current protection (OCP), over-voltage protection (OVP), under-voltage protection (UVP), programmable soft start, and thermal shutdown.

The MP8862 is available in a 16-pin QFN (3mmx3mm) package.

ELECTRICAL SPECIFICATION

Parameter	Symbol	Value	Units
Operating Input Voltage	V_{IN}	12	V
Switching Frequency	F_s	500	kHz
Output Voltage	V_{OUT}	5	V
Output Current	I_{OUT}	2	A

FEATURES

- Wide 2.8V to 22V Operating Input Voltage Range
- 1V ⁽¹⁾ to 20.47V Output Voltage Range (5V Default) with 10mV Resolution through I²C
- 2A Output Current or 4A Input Current
- Four Low $R_{DS(ON)}$ Internal Buck Power MOSFETs
- Adjustable Accurate CC Output Current Limit with Internal Sensing MOSFET via I²C
- 500kHz Switching Frequency
- Output Over-Voltage Protection (OVP) Hiccup
- Output Short-Circuit Protection (SCP) with Hiccup
- Over-Temperature Warning and Shutdown
- I²C Interface with ALT Pin
- Four Programmable I²C Addresses
- One-Time Programmable (OTP) Non-Volatile Memory
- I²C Programmable Line Drop Compensation, PFM/PWM Mode, Soft Start, OCP, etc.
- EN Shutdown Discharge Programmable
- Available in a QFN-16 (3mmx3mm) Package

APPLICATIONS

- USB PD Sourcing Ports
- Buck-Boost Bus Supplies

All MPS parts are lead-free, halogen-free, and adhere to the RoHS directive. For MPS green status, please visit the MPS website under Quality Assurance. "MPS" and "The Future of Analog IC Technology" are registered trademarks of Monolithic Power Systems, Inc.

NOTE:

- 1) For $V_{OUT} < 3V$ applications, the switching frequency decreases.

EV8862-Q-00A EVALUATION BOARD

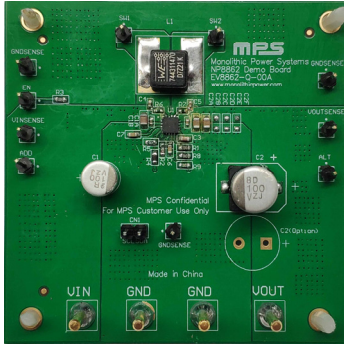

(L x W) 6.35cm x 6.35cm (Four Layer PCB)	
Board Number	MPS IC Number
EV8862-Q-00A	MP8862GQ-0000

Efficiency vs. Output Current

$V_{IN}=12V$, $V_{OUT}=5V$, Forced PWM Mode

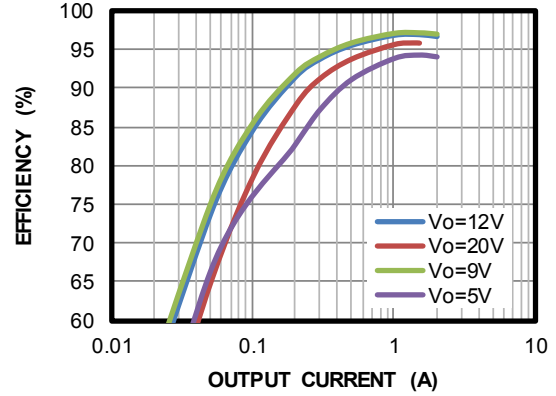

OTP E-FUSE SELECTION TABLE BY DEFAULT (MP8862GQ-0000)

OTP Items	Default Value
Output voltage	5V
IOUT_LIMIT	3A (For 21.5kΩ OC resistor)
Switching frequency	500kHz
Mode	Forced PWM mode
Soft start time	900μs
Line drop compensation	No line drop compensation
Output voltage discharge mode	Enabled
OCP_OVP protection mode	Hiccup
OTP configure code (ID1)	0x00

EVALUATION BOARD SCHEMATIC

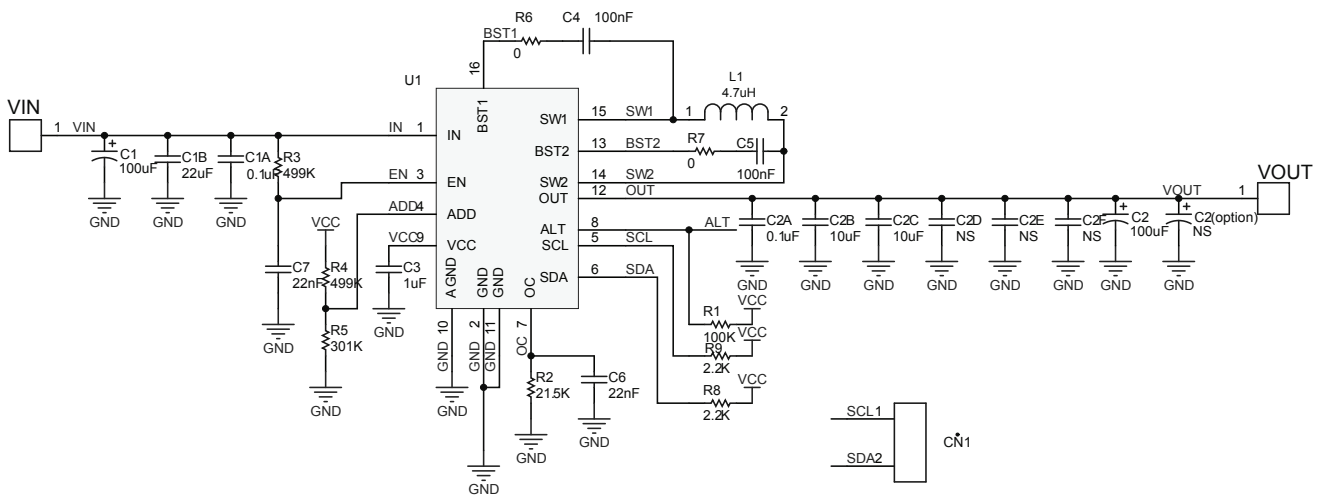

EV8862-Q-00A BILL OF MATERIALS

RefDes	Value	Description	Package	Manufacturer	Manufacturer P/N
C1	100μF	Electrolytic cap, 35V	SMD	CHEMICON	EMZJ350ADA101MF80G
C1B	22μF	Ceramic Cap.,25V,X5R	0805	TDK	C2012X5R1E226M
C2B,C2C	10μF	Ceramic Cap.,25V,X5R	0805	Murata	GRM21BR61E106MA73L
C2	100μF	Electrolytic cap, 35V	SMD	CHEMICON	EMZJ350ARA101MHA0G
C3	1μF	Ceramic Cap.,16V,X5R	0603	WE	885012106017
C1A, C2A, C4,C5	100nF	Ceramic Cap.,50V,X7R	0402	SAMSUNG	CL05B104KB5NNNC
C6, C7	22nF	Ceramic Capacitor, 50V, X5R	0603	Murata	GRM188R71H223KA01D
L1	4.7μH	Inductor, RDC=19.5mOhm, Isat=7A	SMD	WE	744311470
R1	100k	Film Res,1%,0603	0603	YAGEO	RC0603FR-07100KL
R2	21.5k	Film Res,1%,0603	0603	YAGEO	RC0603FR-0721K5L
R3,R4	499k	Film Res,1%,0603	0603	YAGEO	RC0603FR-07499KL
R5	301k	Film Res,1%,0603	0603	YAGEO	RC0603FR-07301KL
R6,R7	0	Film Res,1%,0402	0402	YAGEO	RC0402FR-070RL
R8,R9	2.2k	Film Res,1%,0603	0603	YAGEO	RC0603FR-072K2L
CN1	test pin	1x2pin, 2.54mm	DIP	WE	61300211121
3*GNDSENSE, ALT, ADD,EN, VOUTSENSE, VINSENSE	test pin	1pin, 2.54mm	DIP	WE	61300111121
VIN, VOUT, GND	2mm copper pin	φ2.0 copper pin	DIP	N/A	φ2.0 copper pin
U1	MP8862	4-Switch Integrated Buck-Boost Converter	QFN-16 (3mm×3mm)	MPS	MP8862

TYPICAL PERFORMANCE CHARACTERISTICS

Performance waveforms are tested on the evaluation board.

$V_{IN} = 12V$, $V_{OUT} = 5V$, $T_A = 25^\circ C$, unless otherwise noted.

ENPWR Bit Enable through I²C Command

Load = 0A

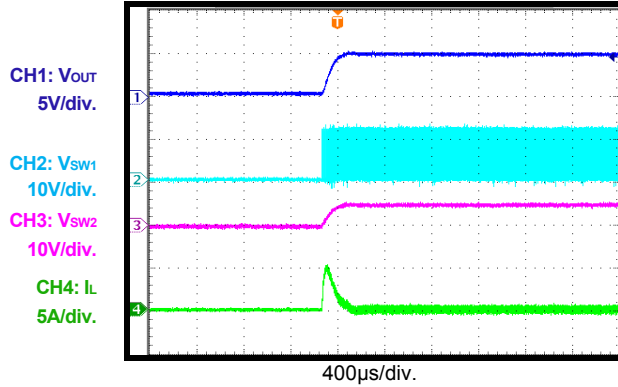

ENPWR Bit Enable through I²C Command

Load = 2A

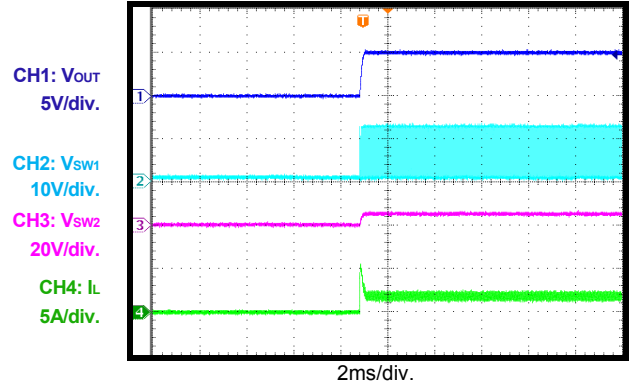

ENPWR Bit Disable through I²C Command

Load = 0A

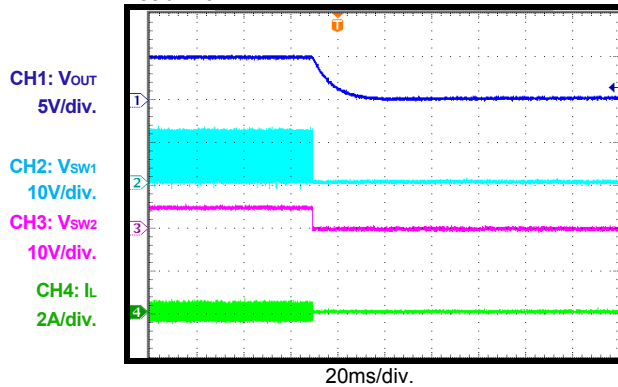

ENPWR Bit Disable through I²C Command

Load = 2A

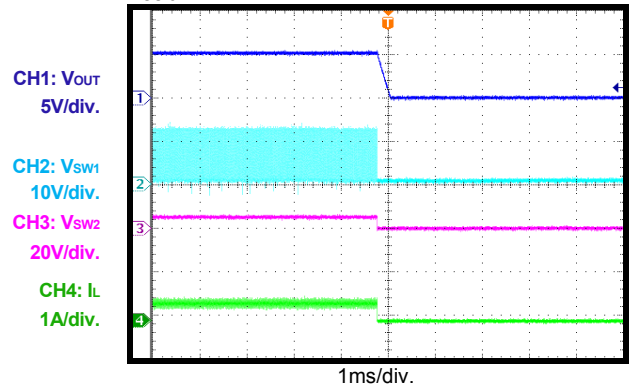

V_{IN} Power Off

Load = 0A

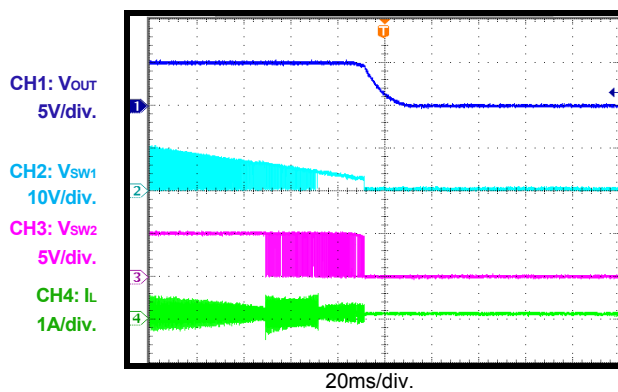

V_{IN} Power Off

Load = 2A

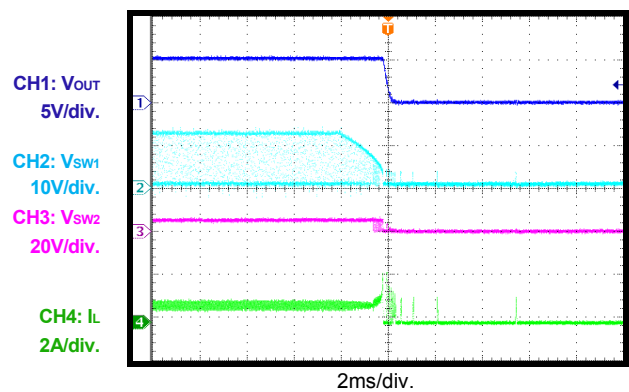

TYPICAL PERFORMANCE CHARACTERISTICS *(continued)*

Performance waveforms are tested on the evaluation board.

$V_{IN} = 12V$, $V_{OUT} = 5V$, $T_A = 25^\circ C$, unless otherwise noted.

V_{IN} Start-Up
Load = 10mA

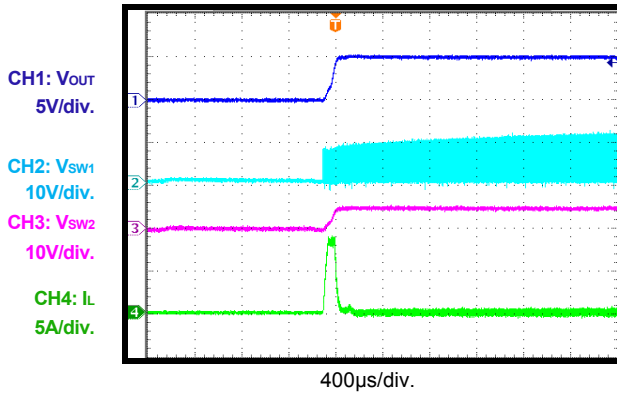

V_{IN} Start-Up
Load = 2A

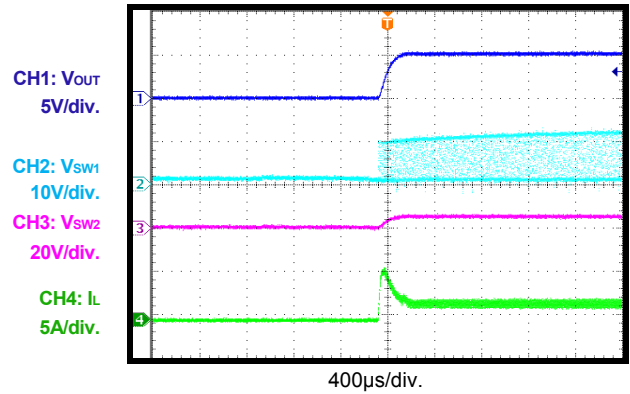

EN Pin Enable
Load = 0A

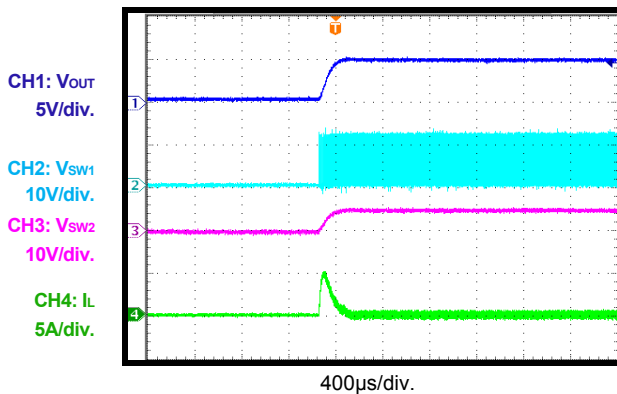

EN Pin Enable
Load = 2A

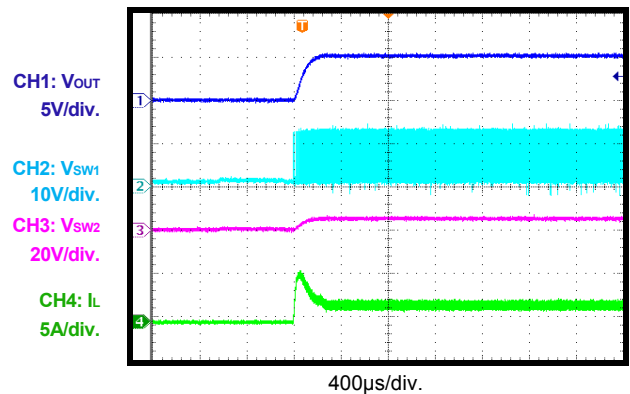

EN Pin Disable
Load = 0A

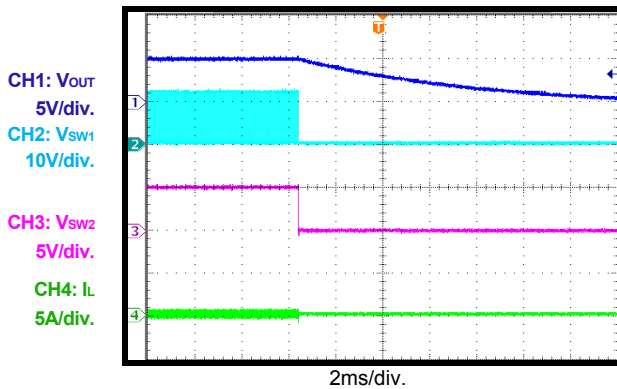

EN Pin Disable
Load = 2A

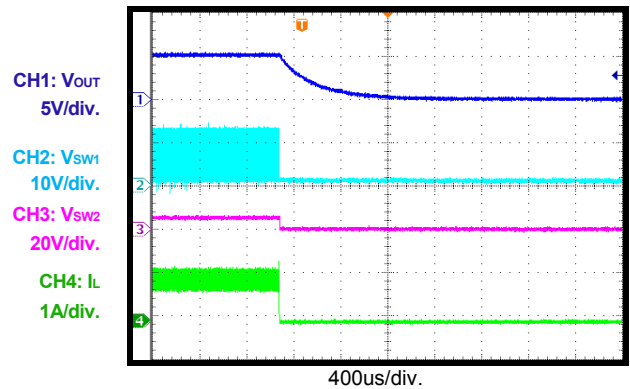

TYPICAL PERFORMANCE CHARACTERISTICS (continued)

Performance waveforms are tested on the evaluation board.

$V_{IN} = 12V$, $V_{OUT} = 5V$, $T_A = 25^\circ C$, unless otherwise noted.

Steady State

$V_{OUT} = 5V$, Load = 0A

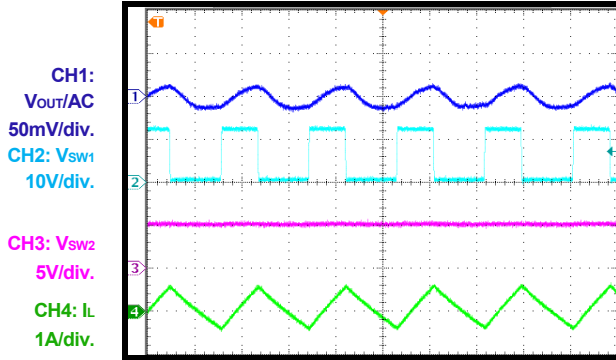

1µs/div.

Steady State

$V_{OUT} = 5V$, Load = 2A

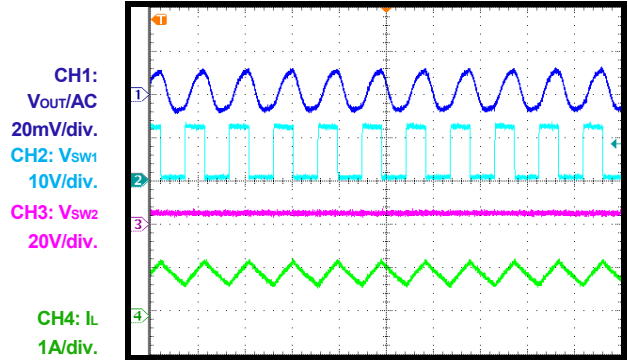

2µs/div.

Load Transient

$V_{IN} = 12V$, $V_{OUT} = 5V$, No Line Drop Compensation, 0A - 1A, 150mA/µs

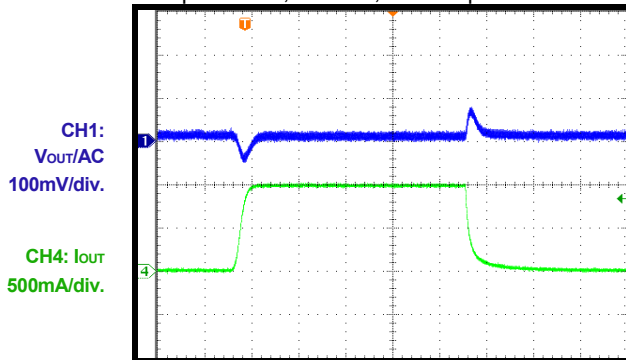

400µs/div.

Load Transient

$V_{IN} = 12V$, $V_{OUT} = 5V$, No Line Drop Compensation, 0A - 2A, 150mA/µs

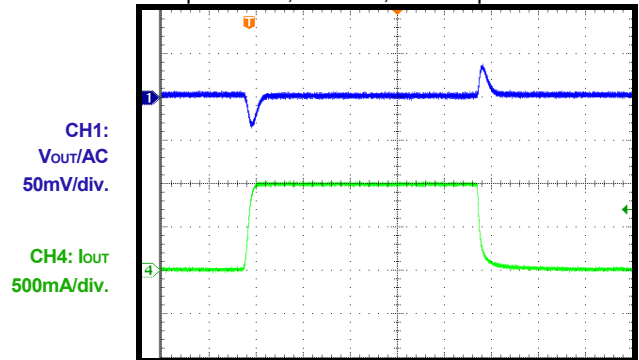

400µs/div.

Load Transient

$V_{IN} = 12V$, $V_{OUT} = 5V$, No Line Drop Compensation, 1A - 2A, 150mA/µs

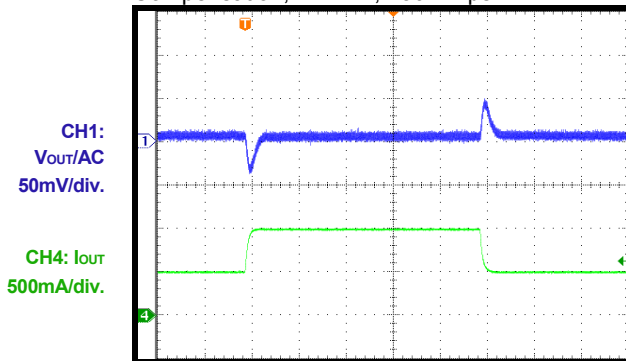

400µs/div.

OCP Entry

$V_{IN} = 12V$, $V_{OUT} = 5V$, Hiccup Mode

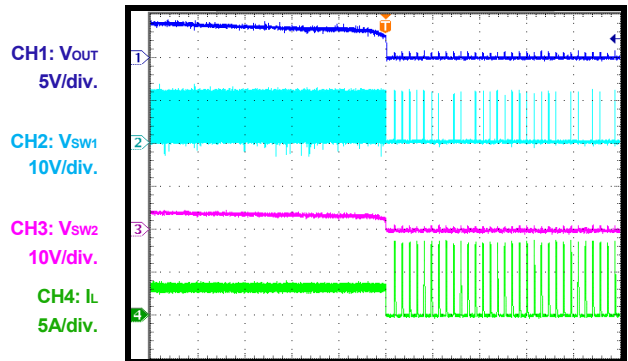

10ms/div.

TYPICAL PERFORMANCE CHARACTERISTICS (continued)

Performance waveforms are tested on the evaluation board.

 $V_{IN} = 12V$, $V_{OUT} = 5V$, $T_A = 25^\circ C$, unless otherwise noted.

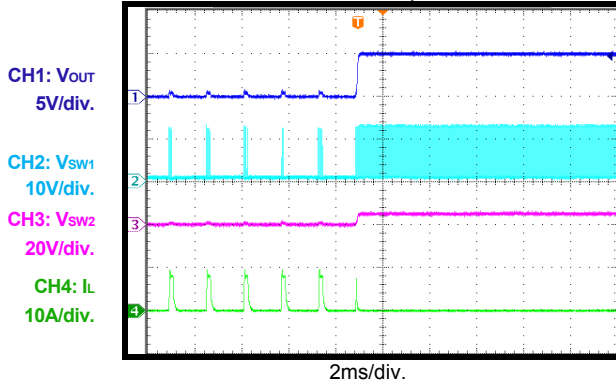
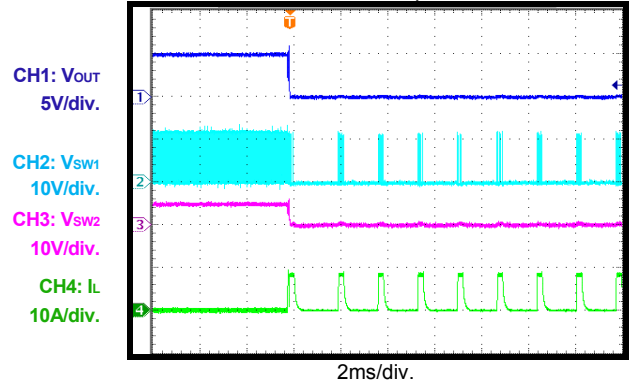
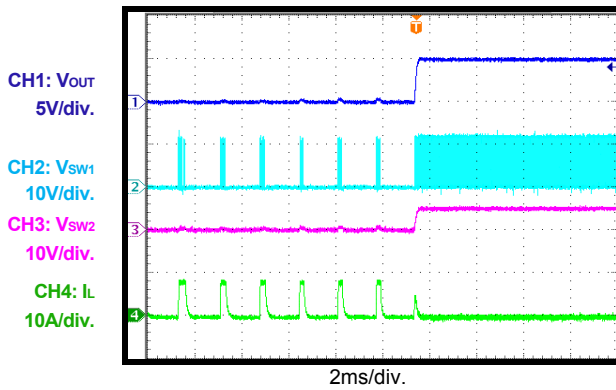
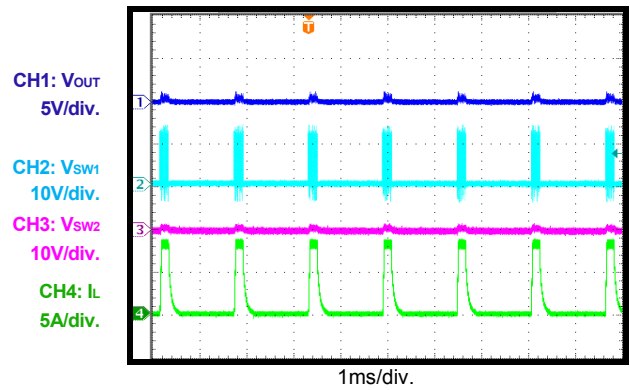
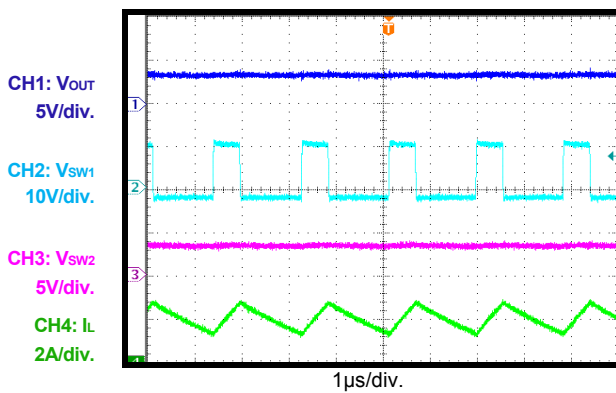
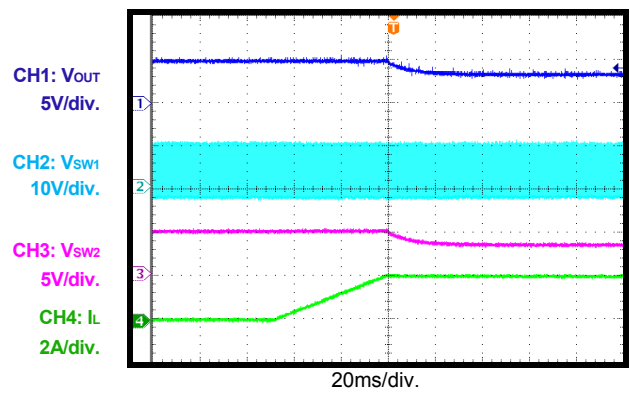
OCP Recovery
 $V_{IN} = 12V$, $V_{OUT} = 5V$, Hiccup Mode

SCP Entry
 $V_{IN} = 12V$, $V_{OUT} = 5V$, Hiccup Mode

SCP Recovery
 $V_{IN} = 12V$, $V_{OUT} = 5V$, Hiccup Mode

SCP Steady
 $V_{IN} = 12V$, $V_{OUT} = 5V$, Hiccup Mode

CC Steady

CC Entry

TYPICAL PERFORMANCE CHARACTERISTICS *(continued)*

Performance waveforms are tested on the evaluation board.

$V_{IN} = 12V$, $V_{OUT} = 5V$, $T_A = 25^{\circ}C$, unless otherwise noted.

OVP

$V_{IN} = 12V$, $V_{OUT} = 5V$, $I_{OUT} = 0A$, Hiccup Mode

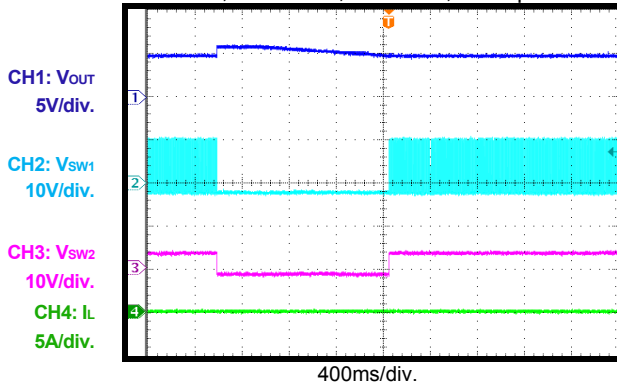

PRINTED CIRCUIT BOARD LAYOUT

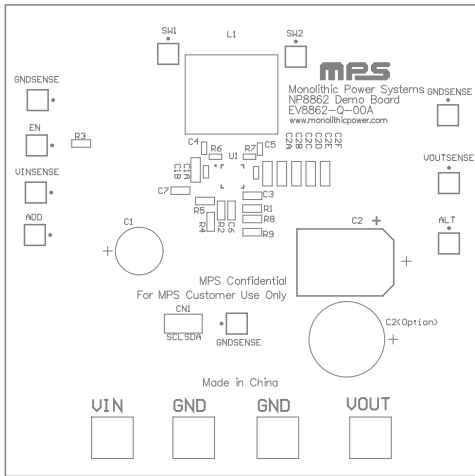

Figure 1—Top Silk Layer

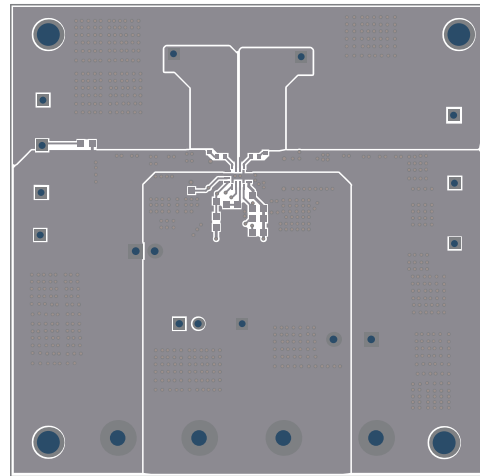

Figure 2—Top Layer

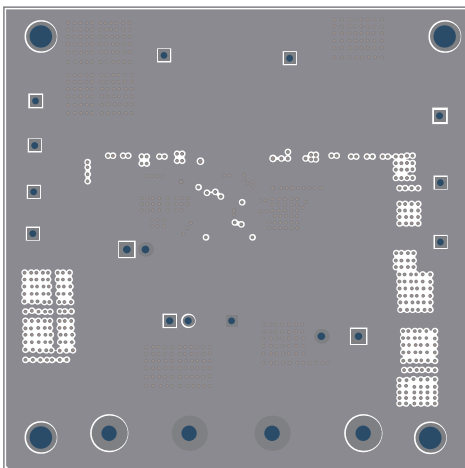

Figure 3—Mid 1 Layer

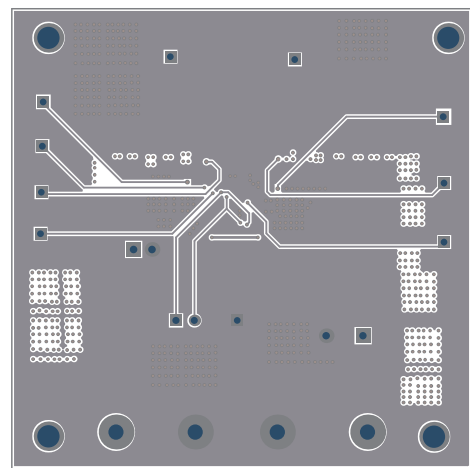

Figure 4—Mid 2 Layer

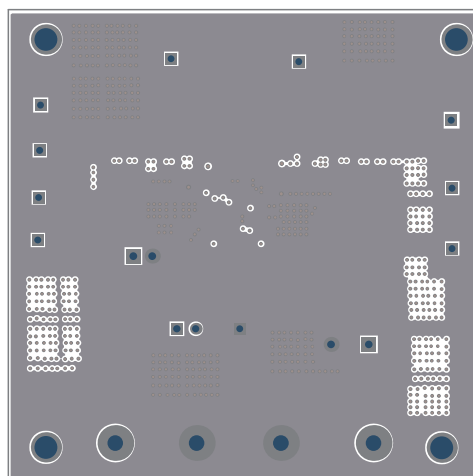

Figure 5—Bottom Layer

QUICK START GUIDE

1. Connect the positive and negative terminals of the load to the Vout and GND pins, respectively.
2. Preset the power supply output 12V, and then turn off the power supply.
3. Connect the positive and negative terminals of the power supply output to the VIN and GND pins, respectively.
4. Turn the power supply on, the board will automatically start up with default settings. The related parameters (refer to datasheet) can be changed by I2C connection.

NOTICE: The information in this document is subject to change without notice. Please contact MPS for current specifications. Users should warrant and guarantee that third party Intellectual Property rights are not infringed upon when integrating MPS products into any application. MPS will not assume any legal responsibility for any said applications.