



The Future of Analog IC Technology®

EV8903DG-00A

Low Dropout 150mA Linear Regulator EV Board

DESCRIPTION

The MP8903 is a low-noise, low-dropout linear regulator. It operates from 2.7V to 6.5V input voltage, and regulates the output voltage with 2% accuracy from 1.5V to 5V.

The MP8903 can supply up to 150mA of load current. The MP8903 features thermal overload protection. It is available in a QFN-8 package.

ELECTRICAL SPECIFICATIONS

Parameter	Symbol	Value	Units
Input Voltage	V _{IN}	3.8 to 6.5	V
Output Voltage ⁽¹⁾	V _{OUT}	3.3	V
Operating Temp		-40 to +85	°C

Note:

1) 3.3V default output voltage adjustable from 1.5V to 5.0V using an external resistor divider.

FEATURES

- Low 150mV Dropout at 150mA Output
- 2% Accurate Output Voltage
- Default Output Voltage Set to 3.3V, Adjustable from 1.5V to 5V using an External Resistor Divider
- Up to 6.5V Input Voltage
- Better Than 0.001%/mA Load Regulation
- Stable With Low-ESR Output Capacitor
- Low 125µA Ground Current
- Internal Thermal Protection

APPLICATIONS

- 802.11 PC Cards
- Mobile Handset PLL Power
- Audio Codec Power

MPS and *The Future of Analog IC Technology* are Registered Trademarks of Monolithic Power Systems, Inc.

EV8903DG-00A EVALUATION BOARD

TBD

(L x W x H) 2.0" x 2.0" x 0.4"
5.0cm x 5.0cm x 1.0cm

Board Number	MPS IC Number
EV8903DG-00A	MP8903DG

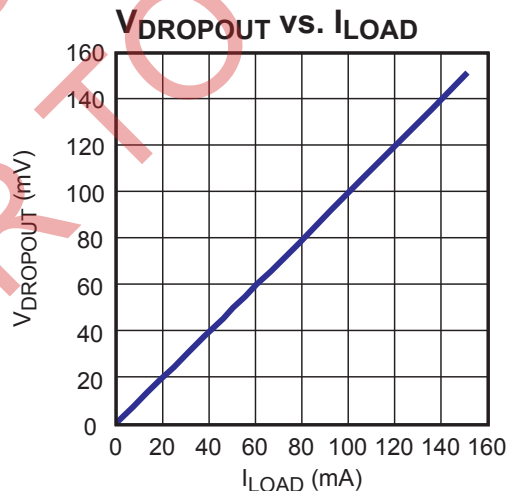

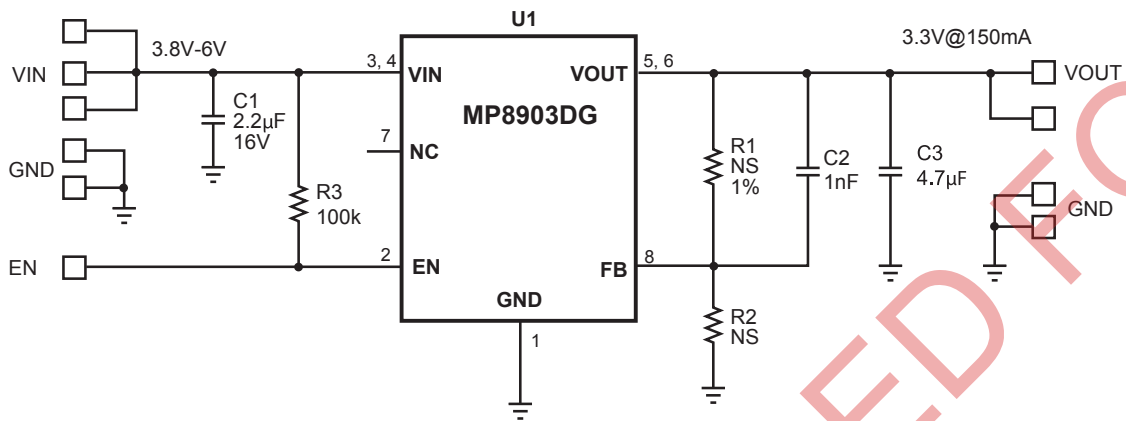
EVALUATION BOARD SCHEMATIC

EV8903DG-00A BILL OF MATERIALS

Qty	Ref	Value	Description	Package	Manufacturer	Manufacturer P/N
1	C1	1uF	Ceramic Cap, 10V, X7R	SM0805	AVX	0805ZC105KAT2A
1	C2	NS	Ceramic Cap, 50V, X7R	603	AVX	06035C104KAT2A
1	C3	2.2uF	Ceramic Cap, 10V, X5R	SM0805	AVX	0805ZD225KAT2A
2	R1, R2	NS	Not Stuffed	603		
1	R3	100kΩ	Film Res, 5%	603	Panasonic	ERJ-6GEYJ104V
1	U1		DC-DC Converter	QFN-8	MPS	MP8903DG

PRINTED CIRCUIT BOARD LAYOUT

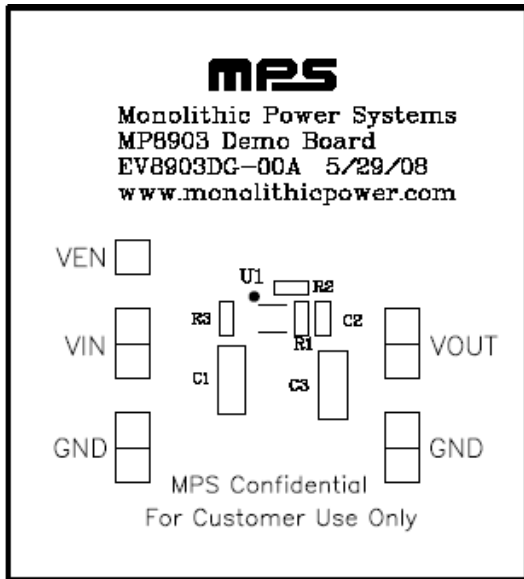

Figure 1—Top Silk Layer

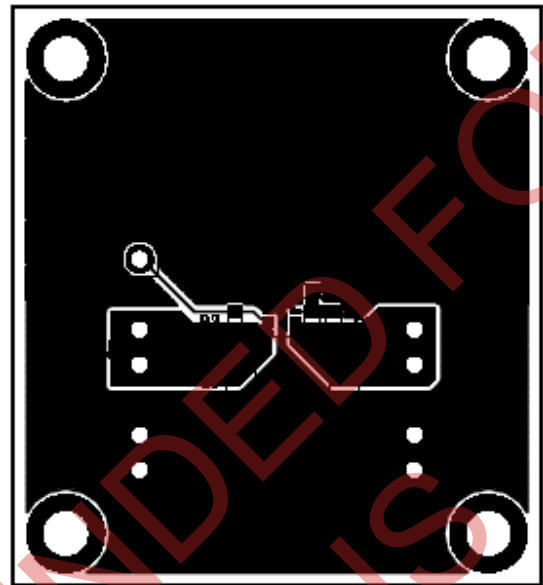

Figure 2—Top Layer

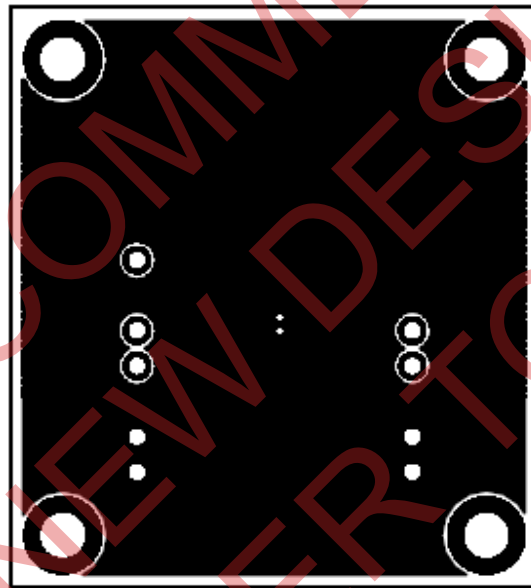

Figure 3—Bottom Layer

QUICK START GUIDE

The output voltage of this board is set to 3.3V. The EN pin is connected to VIN with a 100kΩ resistor for automatic startup. You can connect EN to GND to disable the MP8903.

1. Attach the positive and the negative ends of the load to the VOUT and GND pins, respectively.
2. Attach an input voltage ($3.5V \leq V_{IN} \leq 6.5V$) and input ground to the VIN and GND pins, respectively.
3. The output voltage (V_{OUT}) can be changed by adding a resistor divider (R1 and R2). A 10kΩ ($\pm 1\%$) resistor should be used for the low-side resistor R2 of the voltage divider. The high side resistor R1 can be determined by the equation:

$$R1 = R2 \times \left(\frac{V_{OUT} - V_{FB}}{V_{FB}} \right)$$

Where V_{FB} is the OUT feedback threshold voltage equal to 1.222V.

The following table lists the R1 selected values for some typical output voltages:

V _{OUT} (V)	R1 (Ω)
1.25	232
1.5	2.26k
1.8	4.75k
2	6.34k
2.5	10.5k
2.8	13k
3	14.7k
3.3	16.9k
4	22.6k
5	30.9k

NOTICE: The information in this document is subject to change without notice. Please contact MPS for current specifications. Users should warrant and guarantee that third party Intellectual Property rights are not infringed upon when integrating MPS products into any application. MPS will not assume any legal responsibility for any said applications.