

DESCRIPTION

The EV9148-J-00A is used for demonstrating the performance of MPS's MP9148, an internally compensated 1MHz fixed-frequency dual PWM synchronous step-down regulator.

MP9148 is ideal for powering portable equipment that runs from a single cell Lithium-ion (Li+) battery due to 45µA low quiescent current. The output voltage can be regulated as low as 0.608V.

With peak current mode control and internal compensation, the MP9148 requires a minimum number of readily available standard external components and is available in an 8-pin TSOT23 package.

ELECTRICAL SPECIFICATION

Parameter	Symbol	Value	Units
Input Voltage	V_{IN}	2.7-6	V
Output Voltage	V_{OUT1}	1.8	V
	V_{OUT2}	1.2	V
Output Current	I_{OUT1}	1	A
	I_{OUT2}	1	A

FEATURES

- Dual 1A Output Current
- Above 93% Peak Efficiency
- Above 80% Light Load Efficiency
- Wide 2.7V to 6V Operating Input Range
- 100mΩ and 40mΩ Internal Power MOSFET
- 1MHz Fixed Switching Frequency
- Adjustable Output from 0.608V to V_{IN}
- 180° Phase-Shifted Operation
- 100% Duty cycle operation
- 45µA Quiescent current
- Cycle-by-cycle Over Current Protection
- Short Circuit Protection with Hiccup Mode
- Thermal shutdown
- Available in 8-pin TSOT23 Package

APPLICATIONS

- Small/Handhold devices
- DVD Drivers
- Portable Instruments
- Smartphone and Feature Phones
- Battery-Powered devices

All MPS parts are lead-free and adhere to the RoHS directive. For MPS green status, please visit MPS website under Quality Assurance. "MPS" and "The Future of Analog IC Technology" are Registered Trademarks of Monolithic Power Systems, Inc.

TYPICAL APPLICATION



Board Number	MPS IC Number
EV9148-J-00A	MP9148GJ

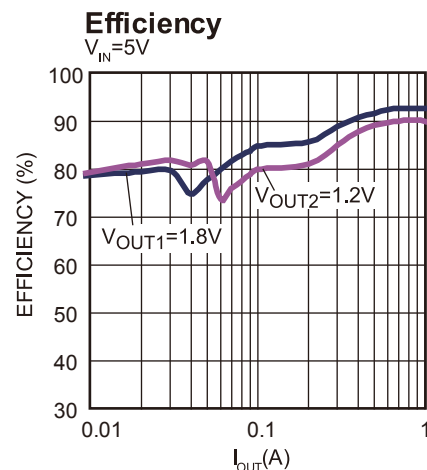

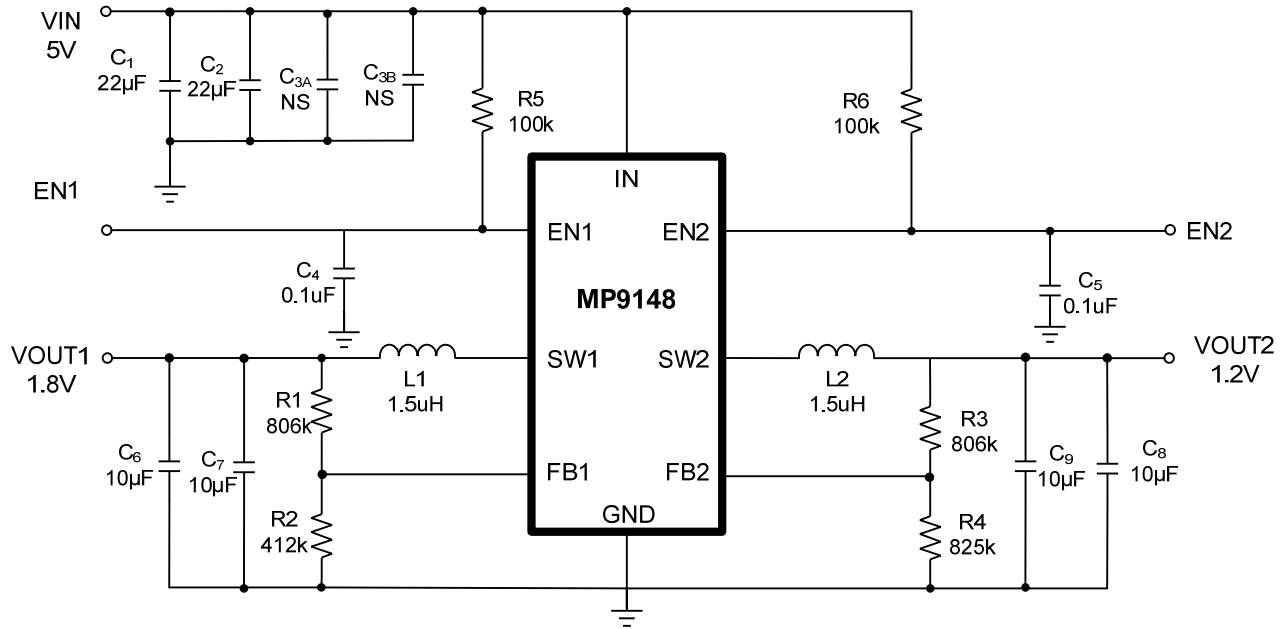
EVALUATION BOARD SCHEMATIC

EV9148-J-00A BILL OF MATERIALS

Qty	Ref	Value	Description	Package	Manufacturer	Manufacturer P/N
1	C1	22µF	Ceramic Cap., 16V, 20%, X5R	0805	muRata	GRM21BR60J226ME39L
1	C2	22µF	Ceramic Cap., 16V, 20%, X5R	0805	muRata	GRM21BR60J226ME39L
0	C3A	NS				
0	C3B	NS				
2	C4, C5	0.1µF	Ceramic Cap, 16V,X7R	0603	muRata	GRM188R71C104KA01D
4	C6, C7, C8, C9	10µF	Ceramic Cap, 16V, 20%, X5R	0805	muRata	GRM21BR61A106KE19L
2	R1, R3	806k	Thick Film, 1/10W, 1%	0603	royal	RL0603FR-07806KL
1	R2	412k	Thick Film, 1/10W, 1%	0603	royal	RL0603FR-07412KL
1	R4	825k	Thick Film, 1/10W, 1%	0603	royal	RL0603FR-07825KL
2	R5, R6	100k	Thick Film, 1/10W, 1%	0603	royal	RL0603FR-07100KL
2	L1, L2	1.5µH	Inductor, 9.57mohm, 11.5A		Würth	744312150
1	U1		DC-DC module	TSOT23-8	MPS	MP9148GJ

EVB TEST RESULTS

Performance waveforms are tested on the evaluation board.

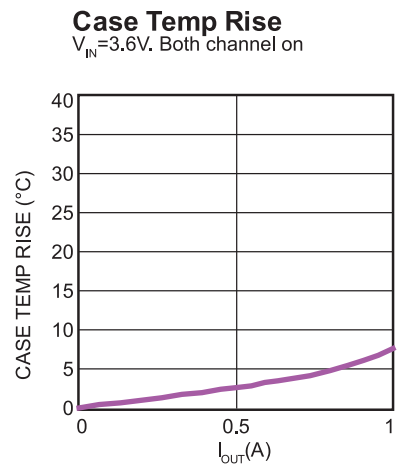
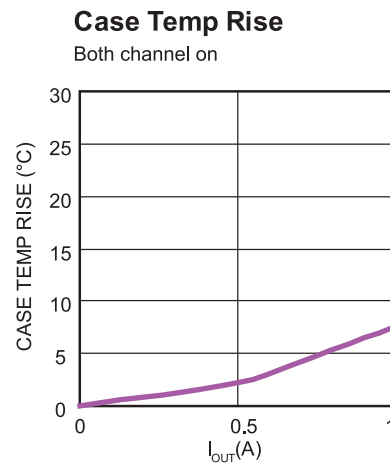
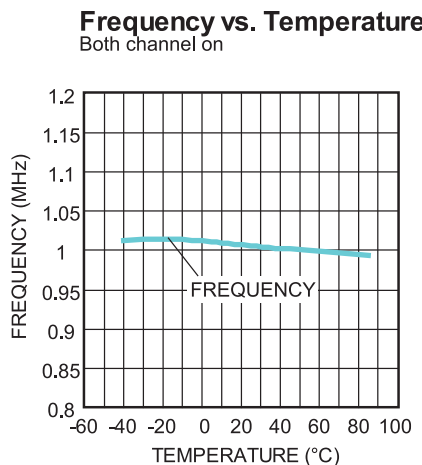
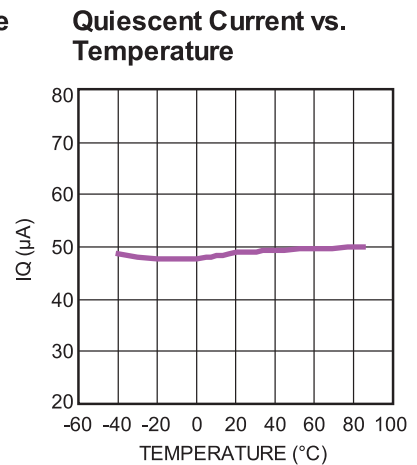
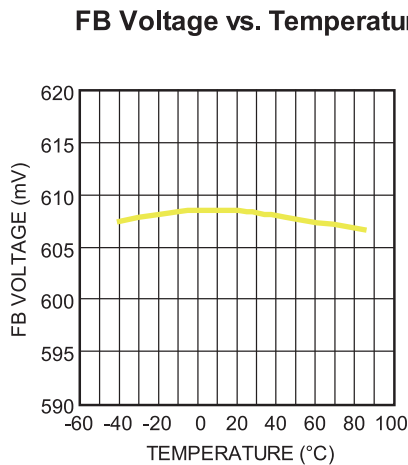
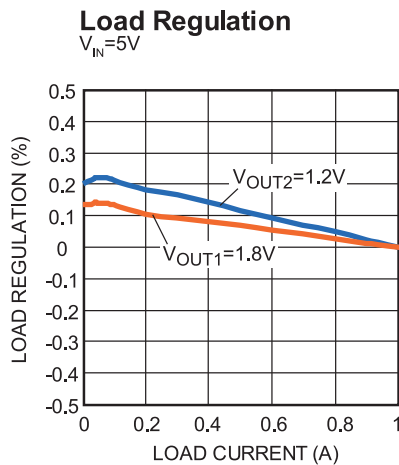
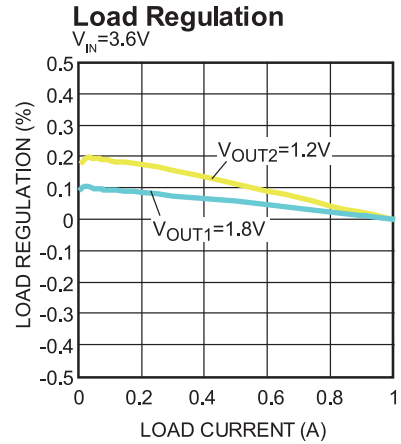
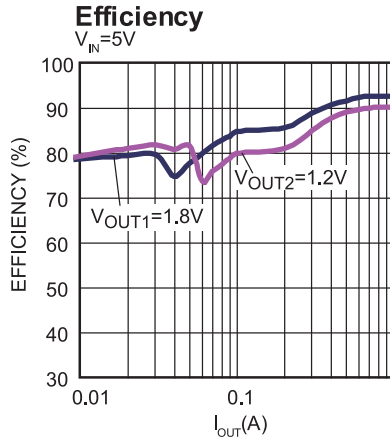
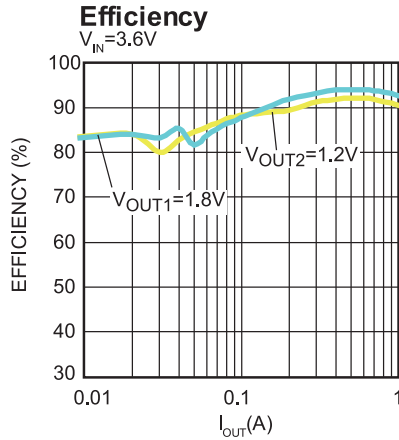
$V_{IN} = 5V$, $V_{OUT1} = 1.8V$, $V_{OUT2} = 1.2V$, $L = 1.5\mu H$, $C_{OUT1}=C_{OUT2}=22\mu F$, $T_A = 25^\circ C$, unless otherwise noted.



EVB TEST RESULTS (continued)

Performance waveforms are tested on the evaluation board.

 $V_{IN} = 5V$, $V_{OUT1} = 1.8V$, $V_{OUT2} = 1.2V$, $L = 1.5\mu H$, $C_{OUT1}=C_{OUT2}=22\mu F$, $T_A = 25^\circ C$, unless otherwise noted.

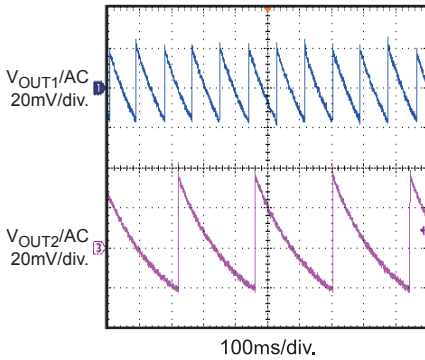
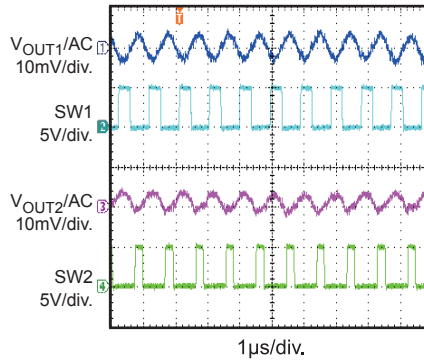
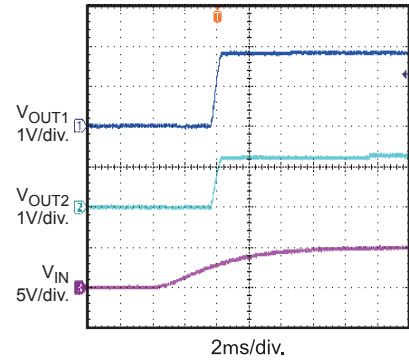
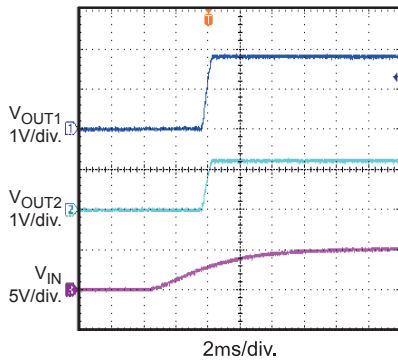
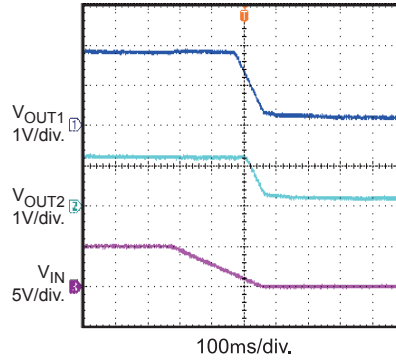
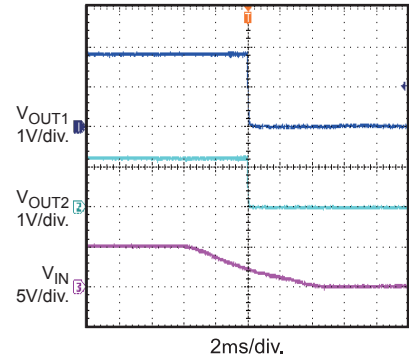
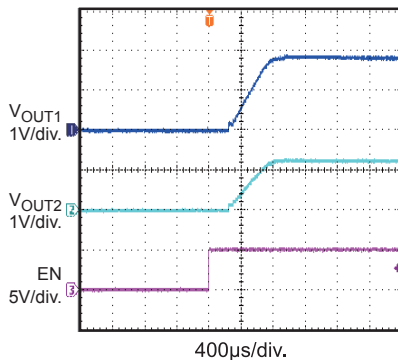
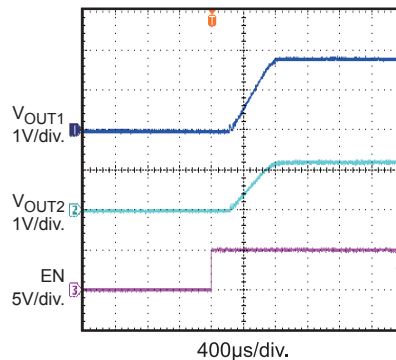
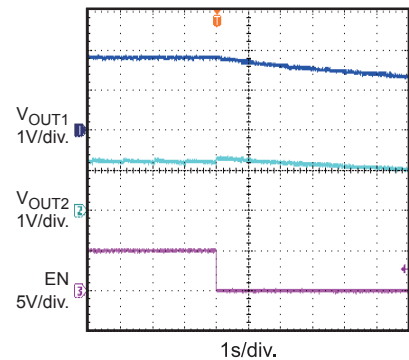
Output Ripple
 $I_{OUT1} = I_{OUT2} = 0A$

Output Ripple
 $I_{OUT1} = I_{OUT2} = 1A$

Vin Power Up without Load
 $I_{OUT1} = I_{OUT2} = 0A$

Vin Power Up with Load
 $I_{OUT1} = I_{OUT2} = 1A$

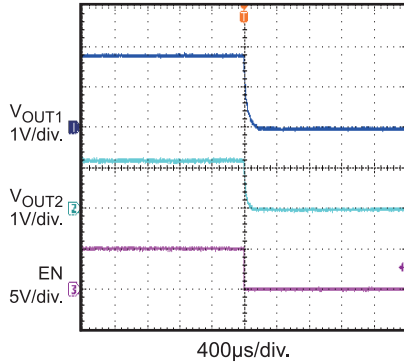
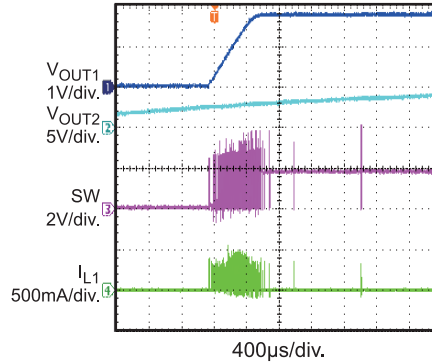
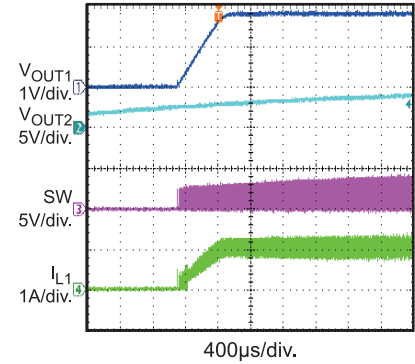
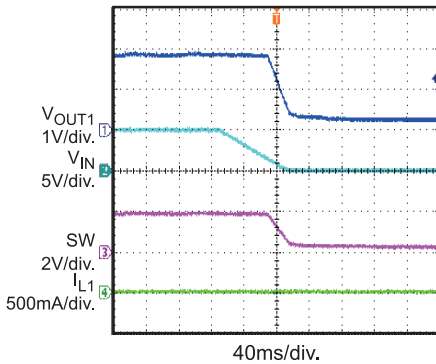
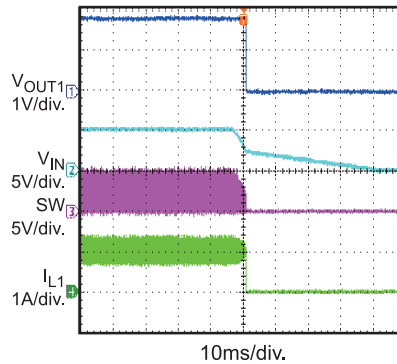
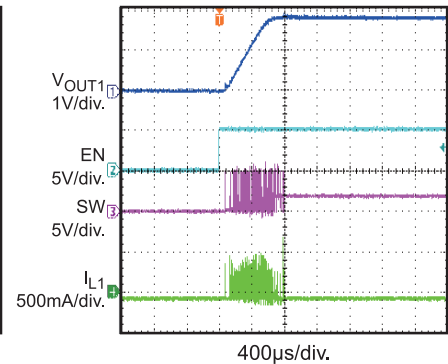
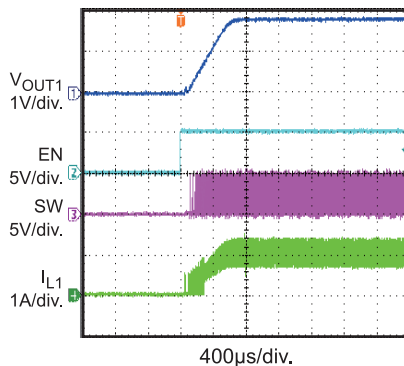
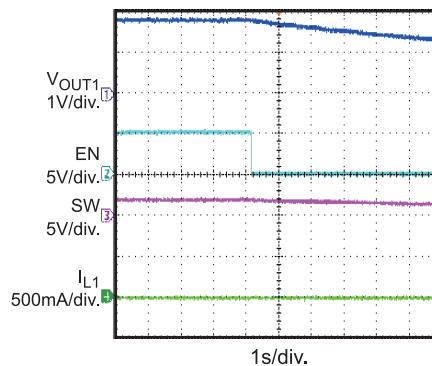
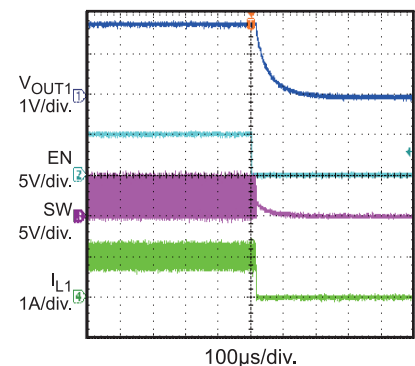
Vin Power Down without Load
 $I_{OUT1} = I_{OUT2} = 0A$

Vin Power Down with Load
 $I_{OUT1} = I_{OUT2} = 1A$

EN On without Load
 $I_{OUT1} = I_{OUT2} = 0A$

EN On with Load
 $I_{OUT1} = I_{OUT2} = 1A$

EN Down without Load
 $I_{OUT1} = I_{OUT2} = 0A$

EVB TEST RESULTS (continued)

Performance waveforms are tested on the evaluation board.

 $V_{IN} = 5V$, $V_{OUT1} = 1.8V$, $V_{OUT2} = 1.2V$, $L = 1.5\mu H$, $C_{OUT1}=C_{OUT2}=22\mu F$, $T_A = 25^\circ C$, unless otherwise noted.

EN Down with Load
 $I_{OUT1} = I_{OUT2} = 1A$

Vin Power On without Load
 $I_{OUT1} = I_{OUT2} = 0A$

Vin Power On
 $I_{OUT1} = 1A, I_{OUT2} = 0A$

Vin Power Down
 $I_{OUT1} = I_{OUT2} = 0A$

Vin Power Down
 $I_{OUT1} = 1A, I_{OUT2} = 0A$

Enable On
 $I_{OUT1} = I_{OUT2} = 0A$

Enable On
 $I_{OUT1} = 1A, I_{OUT2} = 0A$

Enable Down
 $I_{OUT1} = I_{OUT2} = 0A$

Enable Down
 $I_{OUT1} = 1A, I_{OUT2} = 0A$

PRINTED CIRCUIT BOARD LAYOUT

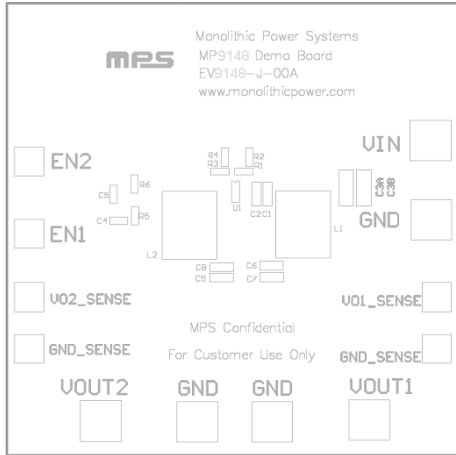

Figure 1—Top Silk Layer

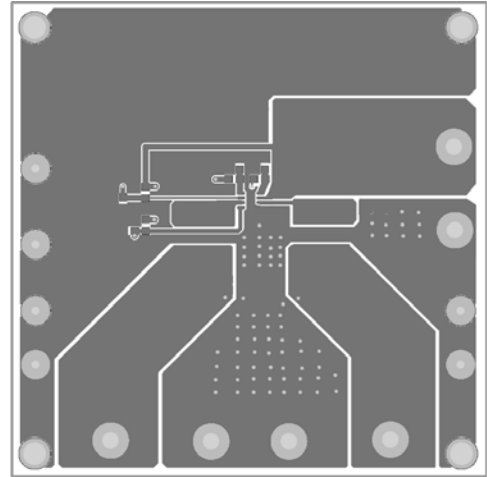

Figure 2—Top Layer

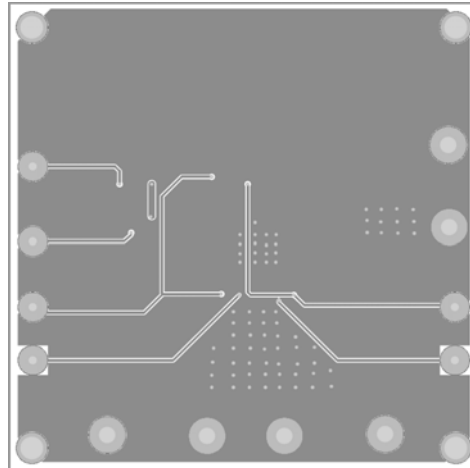

Figure 3—Bottom Layer

QUICK START GUIDE

The board layout accommodates most commonly used components.

1. Connect the positive and negative terminals of the load to VOUT1, VOUT2 and GND pins, respectively.
2. Preset Power Supply output between 2.7V and 6V, and turn off the power supply.
3. Connect Power Supply terminals to:
 - a. Positive (+): VIN
 - b. Negative (–): GND
4. Turn Power Supply on after making connections. The board will automatically start-up.
5. To use the Enable function, apply a digital input to the EN pin. Drive EN higher than 1.2V to turn on the regulator or less than 0.4V to turn it off.

NOTICE: The information in this document is subject to change without notice. Users should warrant and guarantee that third party Intellectual Property rights are not infringed upon when integrating MPS products into any application. MPS will not assume any legal responsibility for any said applications.