



The Future of Analog IC Technology®

EV9472-J-00A

11V to 18V IN, 0.4A OUT

Non-Synchronous Buck Converter

DESCRIPTION

The EV9472-J-00A is the evaluation board of MPS'MP9472 non-synchronous buck converter. The board has a continuous output current up to 0.4A. The output voltage is preset to 8.4V, but can be easily adjusted to other levels from 0.923V. Current mode control provides fast transient response and cycle-by-cycle current limit. Fault condition protections include cycle-by-cycle current limiting, thermal shutdown and under-voltage lockout. Programmable soft-start reduces turn-on stress. Small TSOT23-8 package minimizes board area.

ELECTRICAL SPECIFICATIONS

Parameter	Symbol	Value	Units
Supply Voltage	V _{IN}	11 to 18	V
Output Voltage	V _{OUT}	8.4	V
Output Current	I _{OUT}	0 to 0.4	A

FEATURES

- Up to 0.4A Output Current on Board
- 11V to 18V Board Work Input Range
- Integrated 175mΩ High-Side FET
- Fixed 340kHz Frequency
- Stable with Low ESR Ceramic Output Capacitors
- Programmable Soft-Start
- Programmable Input Under Voltage Lockout
- 8-Pin TSOT23-8 Package

APPLICATIONS

- Distributed Power Systems
- Networking Systems
- FPGA, DSP, ASIC Power Supplies
- Green Electronics/ Appliances
- Notebook Computers

All MPS parts are lead-free, halogen free, and adhere to the RoHS directive. For MPS green status, please visit MPS website under Quality Assurance. "MPS" and "The Future of Analog IC Technology" are Registered Trademarks of Monolithic Power Systems, Inc.

EV9472-J-00A EVALUATION BOARD



(L x W x H) 2.5" x 2.5" x 0.5"

Board Number	MPS IC Number
EV9472-J-00A	MP9472GJ

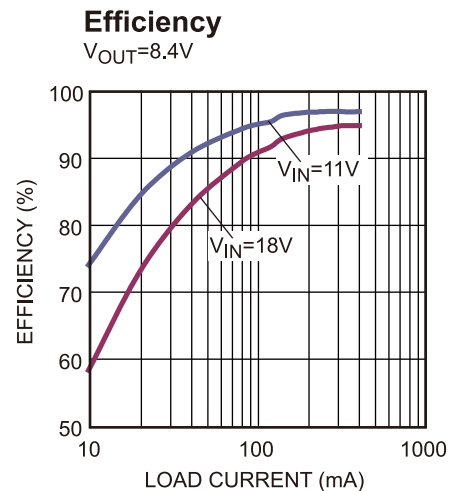

EVALUATION BOARD SCHEMATIC

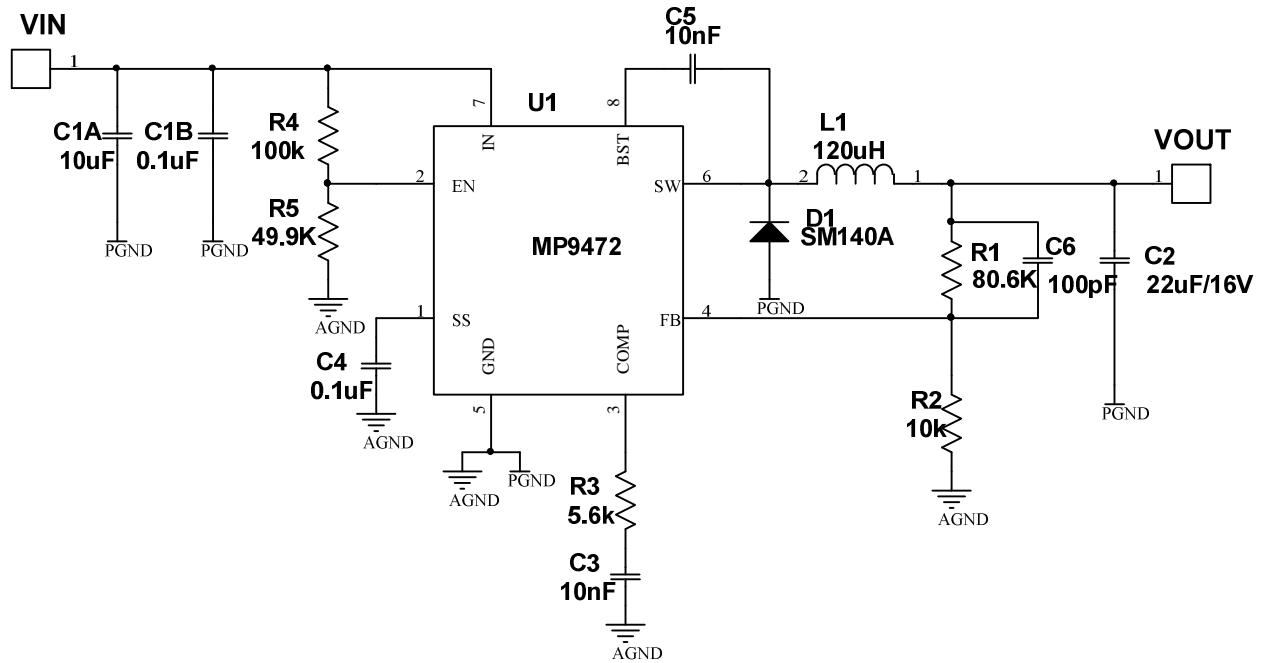

EV9472-J-00A BILL OF MATERIALS

Qty	Ref	Value	Description	Package	Manufacturer	Part Number
1	C1A	10 μ F	Ceramic Cap, 25V,X7R	1210	muRata	GRM32DR71E106KA12L
2	C1B,C4	0.1 μ F	Ceramic Cap, 25V,X7R	0603	muRata	GRM188R71E104KA01D
1	C2	22 μ F	Ceramic Cap,25V,X7R	1210	muRata	GRM32ER71E226KE15L
2	C3,C5	10nF	Ceramic Cap, 25V,X7R	0603	muRata	GRM188R71E103KA01D
1	C6	100pF	Ceramic Cap, 50V,C0G	0603	muRata	GRM1885C1H101JA01D
1	R1	80.6k	Film Res,1%	0603	ROYAL	RC0603FR-0780K6L
1	R2	10k	Film Res,1%	0603	ROYAL	RL0603FR-0710KL
1	R3	5.6k	Film Res,1%	0603	ROYAL	RL0603FR-075K6L
1	R4	100k	Film Res,1%	0603	ROYAL	RL0603FR-07100KL
1	R5	49.9k	Film Res,1%	0603	ROYAL	RL0603FR-0749K9L
1	D1	SM140A	1A 40V diode	SMA	LRC	SM140A
1	L1	120 μ H	Inductor	12x12x6mm	WURTH	744771212
1	U1	MP9472	DCDC Converter	TSOT23-8	MPS	MP9472

EVB TEST RESULTS

Performance waveforms are tested on the evaluation board.
 $V_{IN}=11V$, $V_{OUT}=8.4V$, $L=120\mu H$, unless otherwise noted.

Efficiency

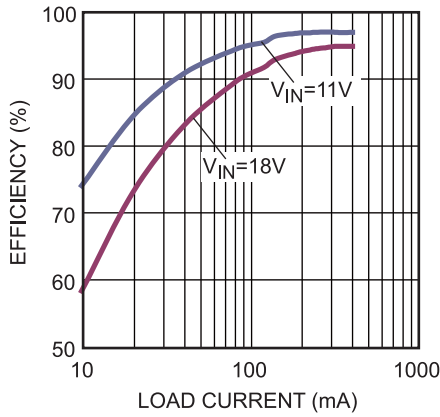

Line Regulation

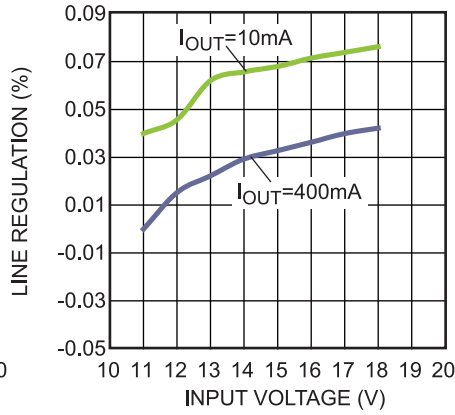

Load Regulation

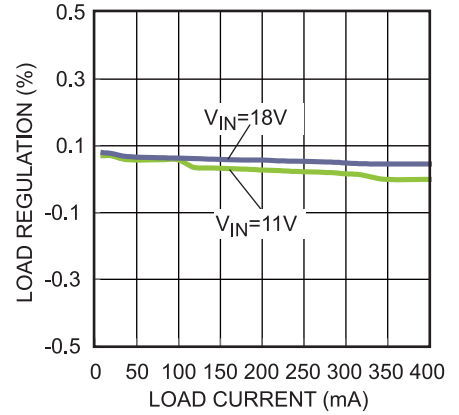

Bode Plot

$I_{OUT}=0.4A$

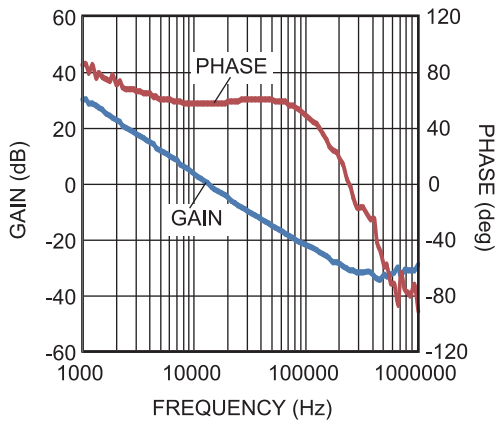

EVB TEST RESULTS (continued)

Performance waveforms are tested on the evaluation board.
 $V_{IN}=11V$, $V_{OUT}=8.4V$, $L=120\mu H$, unless otherwise noted.

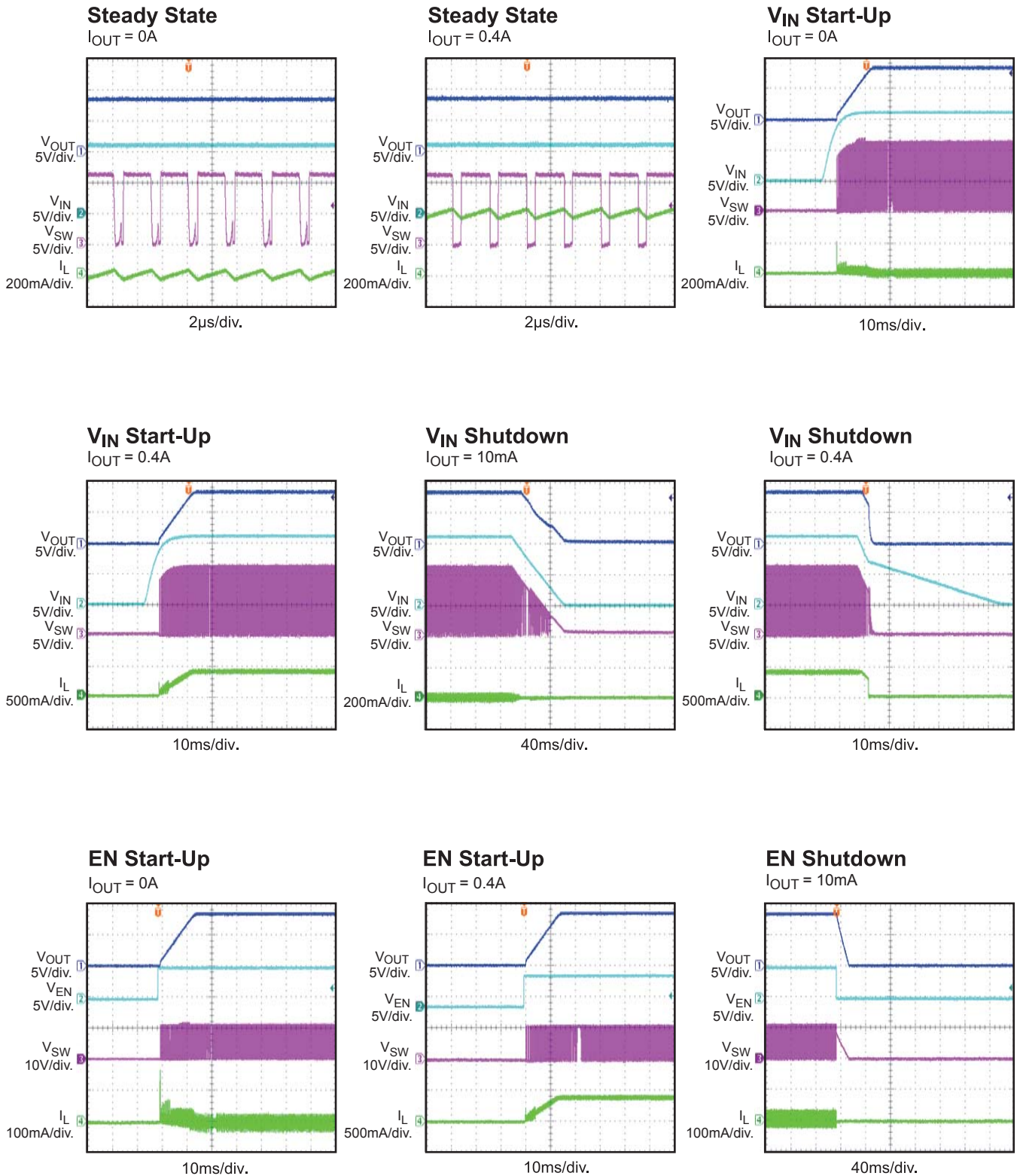

EVB TEST RESULTS *(continued)*

Performance waveforms are tested on the evaluation board.
 $V_{IN}=11V$, $V_{OUT}=8.4V$, $L=120\mu H$, unless otherwise noted.

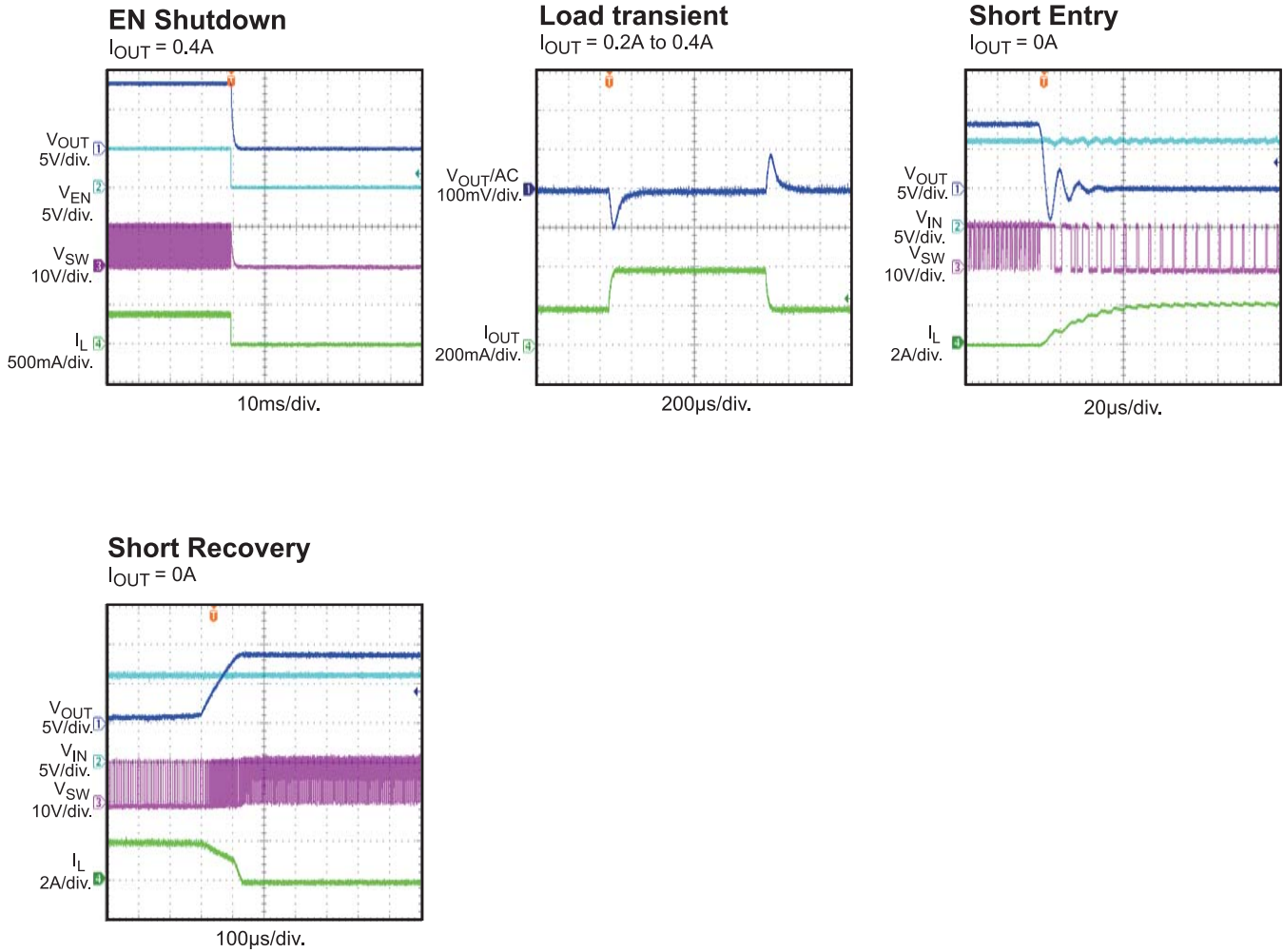

PRINTED CIRCUIT BOARD LAYOUT

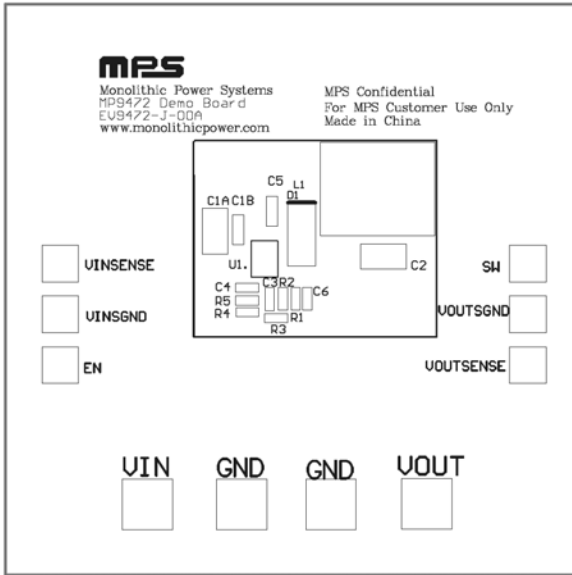

Figure 1—Top Silk Layer

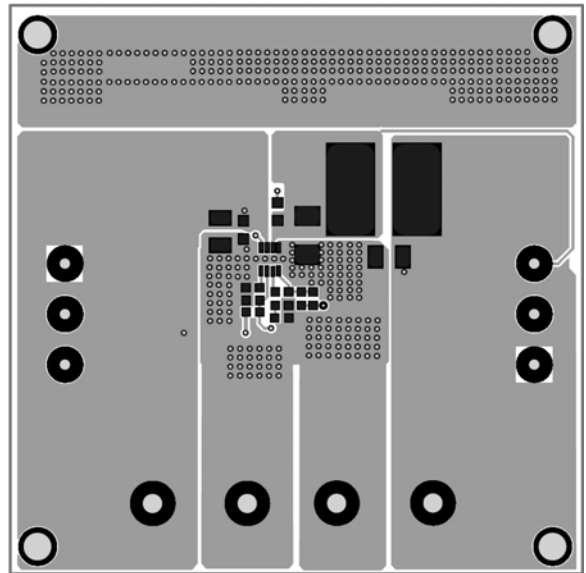

Figure 2—Top Layer

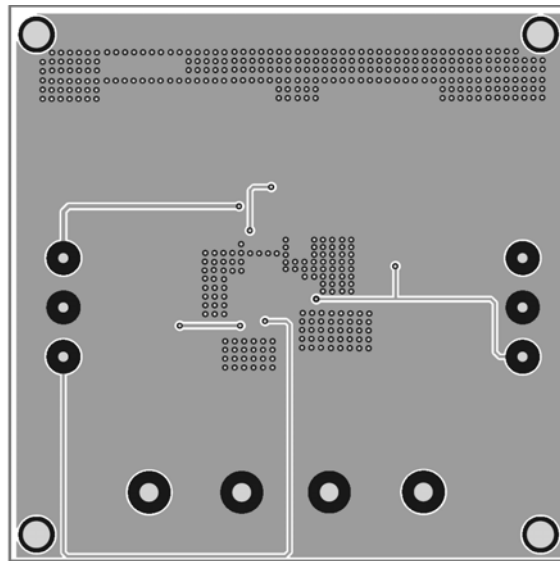

Figure 3—Bottom Layer

QUICK START GUIDE

1. Connect the positive terminals of the load to the VOUT pin and the negative terminals to the GND pin.
2. Preset the power supply output to 11V to 18V and turn it off.
3. Connect the positive terminal of the power supply output to the VIN pin and the negative terminal to the GND pin
4. Turn on the power supply, the MP9472 will automatically startup.
5. To use the Enable function, apply a digital input to the EN pin. Drive EN higher than 2.7V to turn on the regulator or less than 0.7V to turn it off.
6. An under voltage lockout (UVLO) function can be implemented by the addition of a resistor divider (R4 and R5). The EN threshold is 2.5V typical, so VIN UVLO threshold is: $\left(1 + \frac{R4}{R5}\right) \times 2.5V$.

NOTICE: The information in this document is subject to change without notice. Please contact MPS for current specifications. Users should warrant and guarantee that third party Intellectual Property rights are not infringed upon when integrating MPS products into any application. MPS will not assume any legal responsibility for any said applications.
