



The Future of Analog IC Technology®

# EV9485-N-00A

500mA, 100V Input  
Step-Down Converter EV Board

## DESCRIPTION

The EV9485-N-00A Evaluation Board is designed to demonstrate the performances of MPS' MP9485 which is a 4.5V-to-100V-input, 500mA-output step-down converter.

The MP9485 employs hysteresis voltage control method to provide fast response to line or load transient. It integrates a high-side high voltage power MOSFET with higher than 0.75A current limit. MPS's proprietary feedback control scheme minimizes the number of external components.

This board is configured for 5V step-down application. The circuit requires only a minimal number of readily-available, standard, and external components.

## ELECTRICAL SPECIFICATION

Parameter	Symbol	Value	Units
Supply Voltage	$V_{IN}$	8 – 95	V
Output Voltage	$V_{OUT}$	5	V
Output Current	$I_{OUT}$	0-0.5	A

## FEATURES

- 8V-to-95V Wide Input Range<sup>(1)</sup>
  - Hysteretic Control: Simple Compensation
  - Up to 1MHz Switching Frequency
  - Hiccup mode Short Circuit Protection
  - Thermal Shut Down
  - 170µA Quiescent Current
  - Available in SOIC8 with Exposed Pad Packages
- Note: 1) The chip itself can accept 4.5V-to-100V DC input.

## APPLICATIONS

- Scooter, E-bike Control Power Supply
- Solar Energy System
- Automotive System Power
- Industrial Power Supply

All MPS parts are lead-free, halogen free, and adhere to the RoHS directive. For MPS green status, please visit MPS website under Quality Assurance.

"MPS" and "The Future of Analog IC Technology" are Registered Trademarks of Monolithic Power Systems, Inc.

## EV9485-N-00A EVALUATION BOARD



(L x W x H) 6.3cm x 6.3cm x 1.3cm

Board Number	MPS IC Number
EV9485-N-00A	MP9485

Efficiency vs. Output Current  
 $V_{OUT}=5V, L=33\mu H$

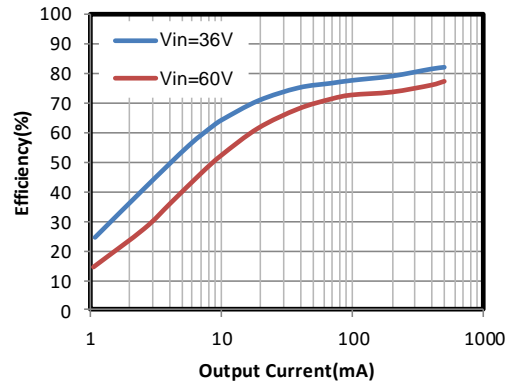

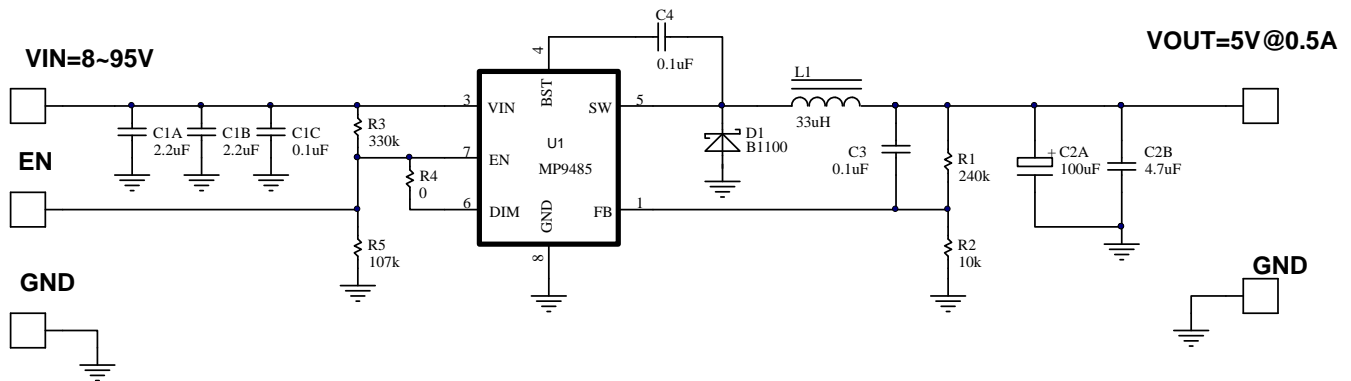
**EVALUATION BOARD SCHEMATIC**

**EV9485-N-00A BILL OF MATERIALS**

Qty	Ref	Value	Description	Package	Manufacturer	Manufacturer P/N
2	C1A, C1B	2.2 $\mu$ F	Ceramic Cap., 100V, X7R	1210	muRata	GRM32ER72A225K
1	C1C	0.1 $\mu$ F	Ceramic Cap., 100V, X7R	0805	muRata	GCM21BR72A104K
1	C2A	100 $\mu$ F	10V, solid tantalum capacitor, ESR=200m $\Omega$	SMD(3.2x6.0)	VISHAY	TR3C107M010C0200
1	C2B	4.7 $\mu$ F	25V X7R Ceramic Capacitor	0805	muRata	GRM21AR71E475KL
2	C3, C4	0.1 $\mu$ F	25V Ceramic Capacitor	0603	muRata	GRM188R71E104KL
1	D1	B1100	100V,1A,schottky diode	SMA	DIODES	B1100-LS
1	L1	33 $\mu$ H	66m $\Omega$ , 2.9A inductor	SMD(10X10)	Würth	7447714330
			82 m $\Omega$ , 1.9A inductor	SMD(9X10)	Würth	744776133
1	R1	240k	Film resistor, 1%	0603	YAGEO	RC0603FR-07240KL
1	R2	10k	Film resistor, 1%	0603	YAGEO	RC0603FR-0710KL
1	R3	330k	Film resistor, 1%	0603	YAGEO	RC0603FR-07330KL
1	R4	0	Film resistor, 5%	0603	YAGEO	RC0603JR-070RL
1	R5	107k	Film resistor, 1%	0603	YAGEO	RC0603FR-07107KL
1	U1	MP9485	100V INPUT, 0.5A STEP-DOWN CONVERTER	SOIC8	MPS	MP9485GN

## EVB TEST RESULTS

Performance waveforms are tested on the evaluation board.

$V_{IN} = 60V$ ,  $V_{OUT} = 5V$ ,  $I_{OUT} = 0.5A$ ,  $T_A = +25^{\circ}C$ , unless otherwise noted. Unless otherwise noted.

Efficiency vs. Output Current

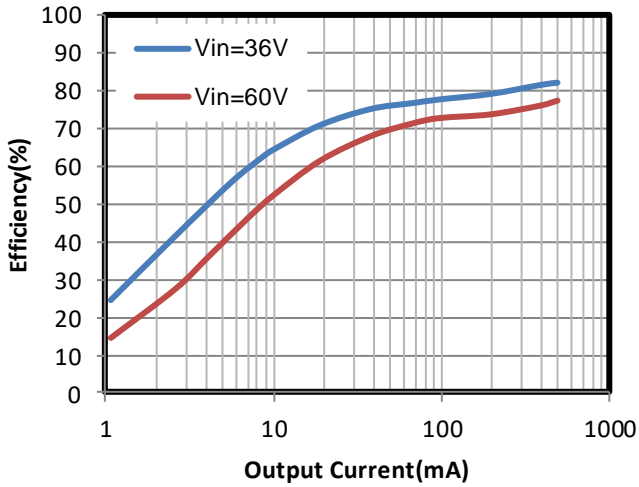

Load Regulation

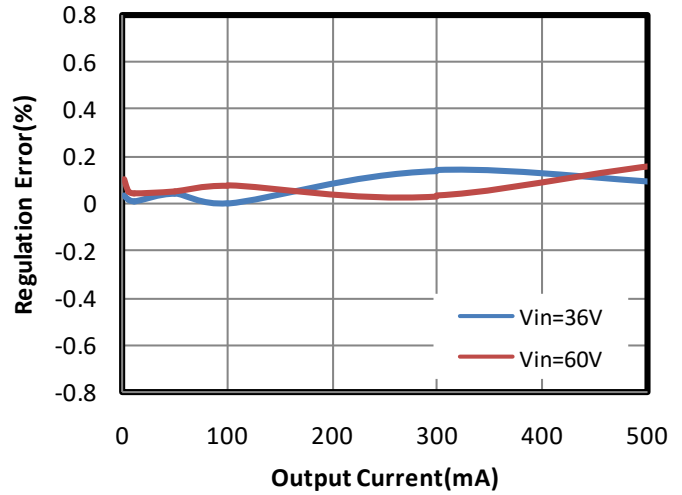

Line Regulation

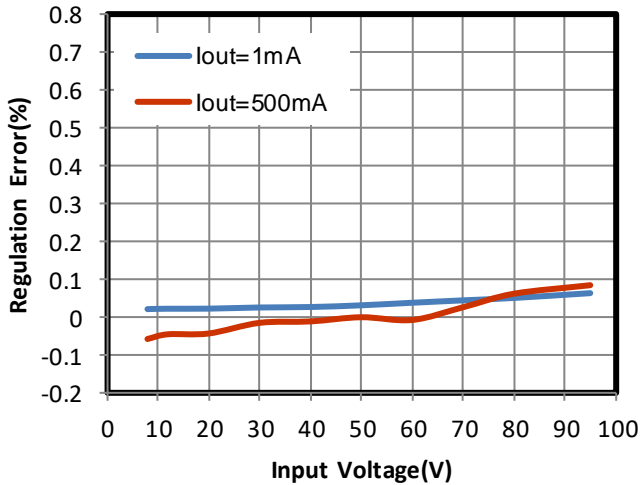

## EVB TEST RESULTS *(continued)*

Performance waveforms are tested on the evaluation board.

$V_{IN} = 60V$ ,  $V_{OUT} = 5V$ ,  $I_{OUT} = 0.5A$ ,  $T_A = +25^\circ C$ , unless otherwise noted. Unless otherwise noted.

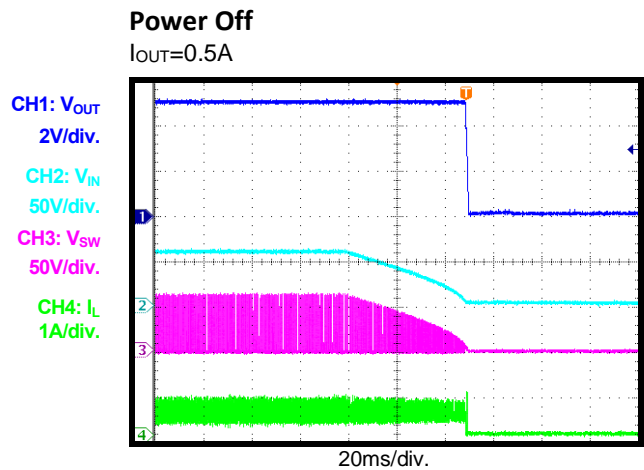
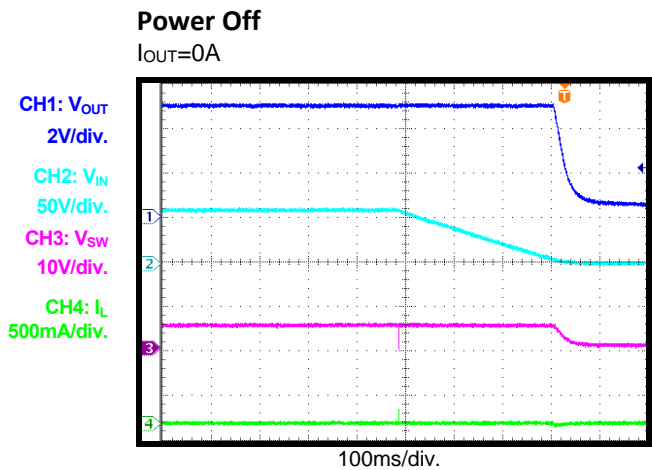
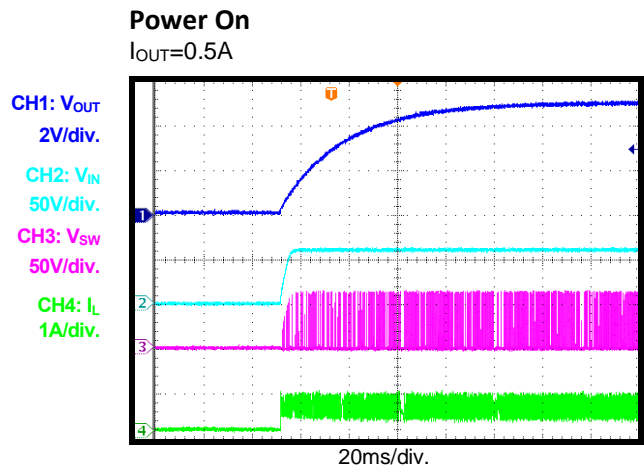
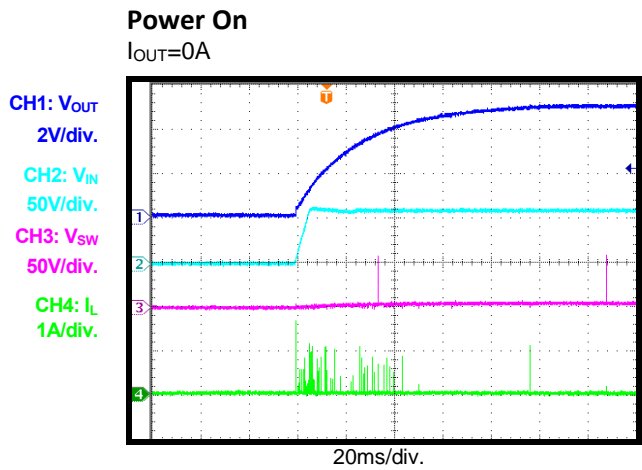
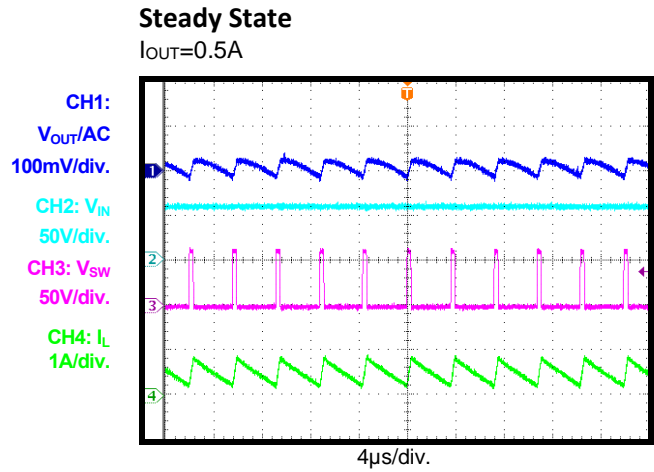
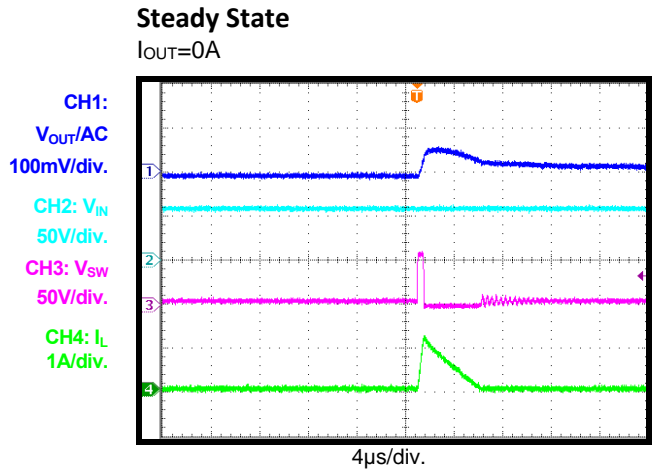

## EVB TEST RESULTS *(continued)*

Performance waveforms are tested on the evaluation board.

$V_{IN} = 60V$ ,  $V_{OUT} = 5V$ ,  $I_{OUT} = 0.5A$ ,  $T_A = +25^\circ C$ , unless otherwise noted. Unless otherwise noted.

### EN Start-Up

$I_{OUT}=0A$

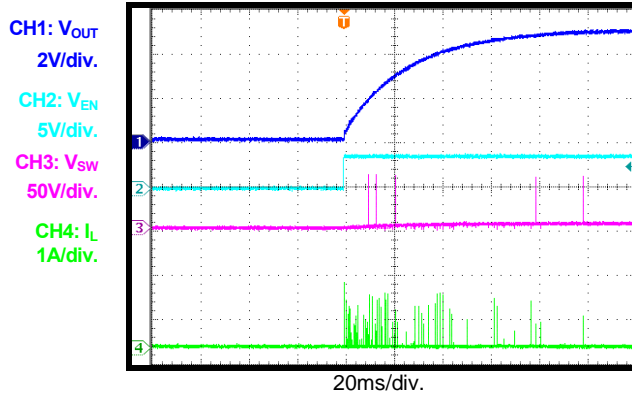

### EN Start-Up

$I_{OUT}=0.5A$

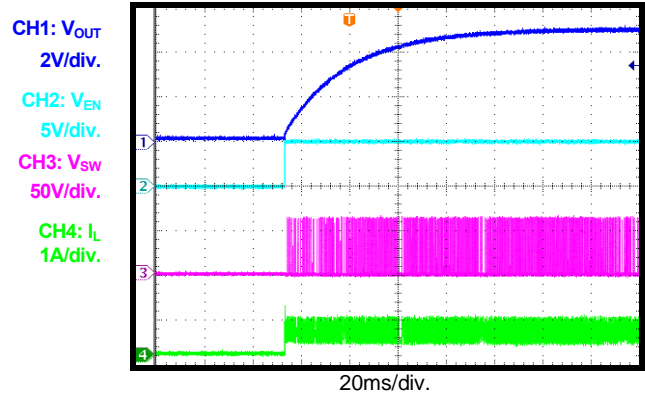

### EN Shutdown

$I_{OUT}=0A$

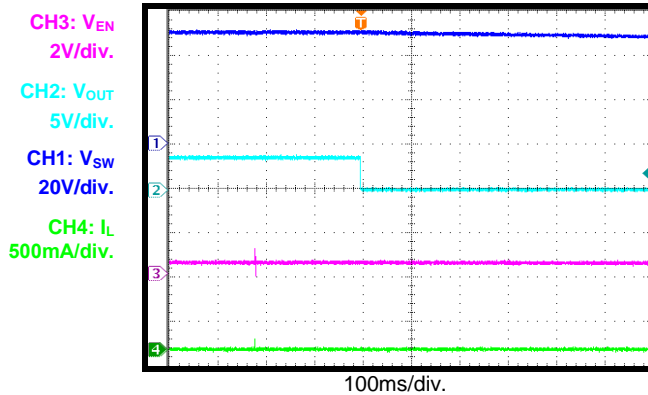

### EN Shutdown

$I_{OUT}=0.5A$

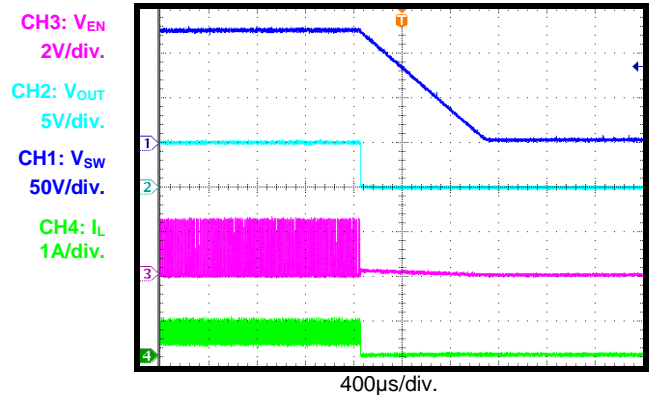

### SCP Entry

$I_{OUT}=0A$

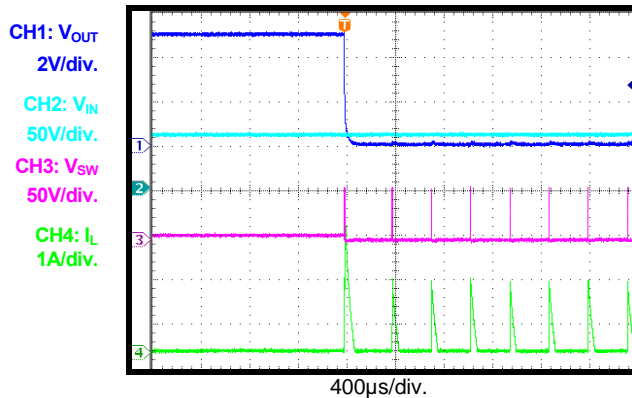

### SCP Recovery

$I_{OUT}=0A$

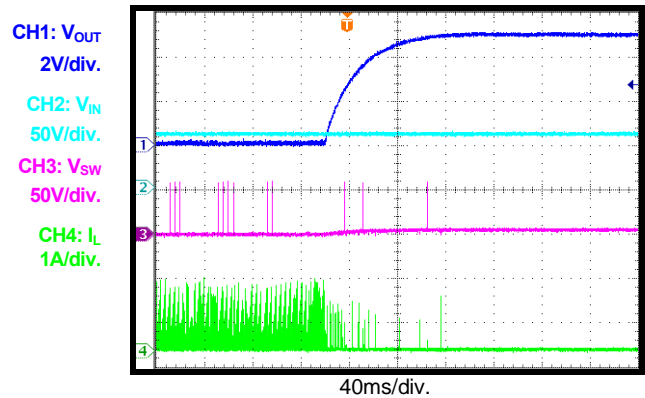

## EVB TEST RESULTS *(continued)*

Performance waveforms are tested on the evaluation board.

$V_{IN} = 60V$ ,  $V_{OUT} = 5V$ ,  $I_{OUT} = 0.5A$ ,  $T_A = +25^\circ C$ , unless otherwise noted. Unless otherwise noted.

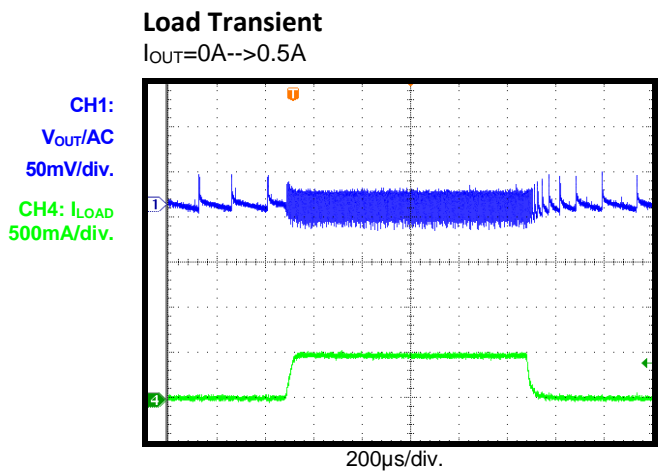
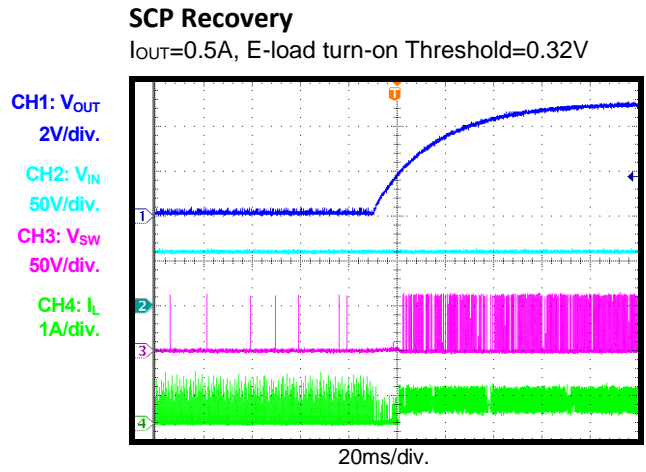
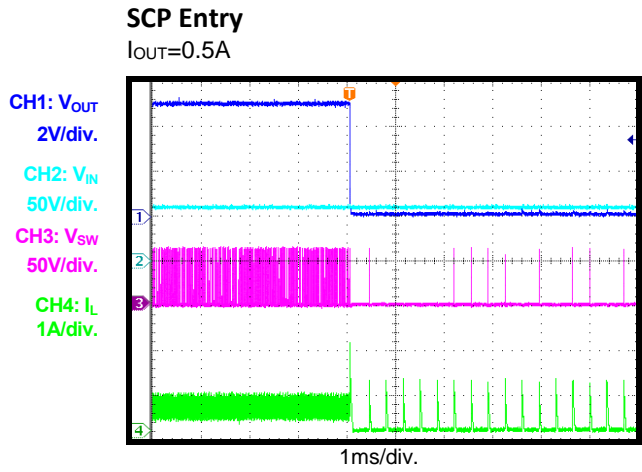

## PRINTED CIRCUIT BOARD LAYOUT

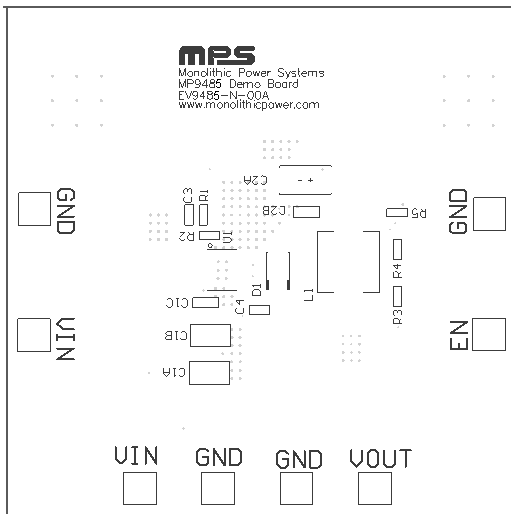

Figure 1: Top Silkscreen Layer

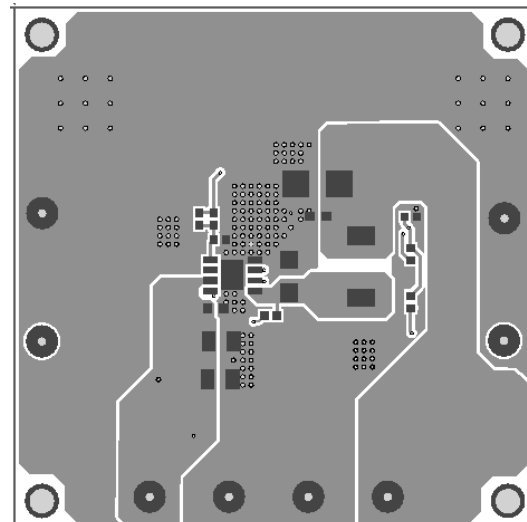

Figure 2: Top Layer

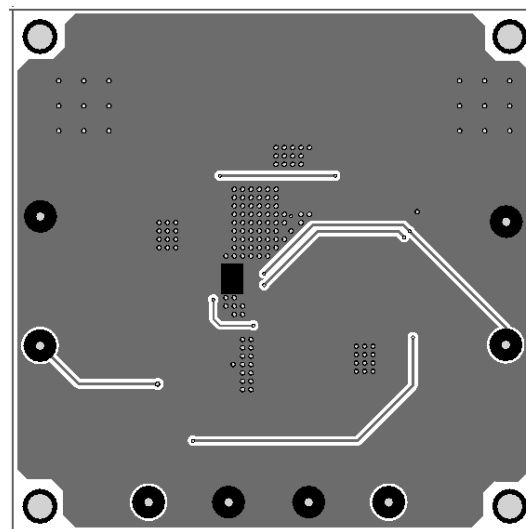

Figure 3: Bottom Layer

## QUICK START GUIDE

The output voltage of this board is set to 5V. With an input ranging from 8V (lower input may cause insufficient BST voltage) to 95V, this board can provide load with 0.5A current. To use this EVB for evaluation, you can do as below:

1. Preset Power Supply to between 8V and 95V.
2. Turn Power Supply off.
3. Preset Load to a value not greater than 0.5A. Note that due to the SCP mechanism MP9485 may startup into SCP mode if the load is on during startup and the turn-on threshold of the E-load is below 0.3V. To improve the startup capability C3's value should be greater.
4. Connect Power Supply terminals to:
  - a. Positive (+): VIN
  - b. Negative (-): GND
5. Connect Load to:
  - a. Positive (+): VOUT
  - b. Negative (-): GND
6. Turn Power Supply on after making connections. The MP9485 will automatically startup to work. The output voltage VOUT can be programmed by changing R2. And the value of R2 can be calculated by the following formula:

$$R_2 = R_1 \times \frac{V_{FB}}{V_{OUT} - V_{FB}}$$

Where  $R_1=240k\Omega$ , and  $V_{FB}=0.2V$ .

7. If EN functions is preferred, apply a high level ( >1.7V) turns on MP9485, low level ( <1V) turns off MP9485. After being turned off, output voltage will be discharged to 0V due to load.

**NOTICE:** The information in this document is subject to change without notice. Please contact MPS for current specifications. Users should warrant and guarantee that third party Intellectual Property rights are not infringed upon when integrating MPS products into any application. MPS will not assume any legal responsibility for any said applications.