

DESCRIPTION

HF920 is a flyback regulator with a monolithic 900V MOSFET. HF920 provides excellent power regulation in AC-DC applications that require high reliability. The switching frequency can be programmed with a single resistor. Also a special frequency doubling mode, designed for strong magnetizing application, can be enabled through a simple external setup.

The EVHF920-SE-00A Evaluation Board is designed to demonstrate the capabilities of HF920. It is designed for off-line high input voltage (85VAC~420VAC) application with triple outputs (13.5V/300mA, 8V/50mA, 8V/50mA). The 8V output rail can power the LDO for MCU power supply.

The EVHF920-SE-00A has an excellent performance and meets EN55022 conducted EMI requirements easily with frequency jittering function. It offers a full suite of protective features such as over-temperature protection, VCC under-voltage lockout, over-voltage protection, over-load protection and short-circuit protection.

ELECTRICAL SPECIFICATION

Parameter	Symbol	Value	Units
Input Voltage	V_{IN}	85 to 420	VAC
Output Voltage1	V_{OUT1}	13.5	V
Output Current1	I_{OUT1}	300	mA
Output Voltage2	V_{OUT2}	8	V
Output Current2	I_{OUT2}	50	mA
Output Voltage3	V_{OUT3}	8	V
Output Current3	I_{OUT3}	50	mA

FEATURES

- Monolithic 900V/15Ω MOSFET and high voltage current source
- Fixed switching frequency, programmable up to 150kHz
- Current-mode control scheme
- Frequency jittering
- Low standby power consumption via active burst mode
- <30mW no load consumption
- Frequency doubling operation mode
- Internal leading-edge blanking
- Built-in soft-start function
- Internal slope compensation
- External input PRO pin protection with hysteresis and auto-restart recovery
- Over Temperature Protection
- VCC Under Voltage Lockout with hysteresis
- Over Voltage Protection on VCC
- Time-based Over Load Protection
- Short Circuit Protection

APPLICATIONS

- E-Meters
- Industrial controls
- Large appliances

All MPS parts are lead-free, halogen free and adhere to the RoHS directive. For MPS green status, please visit MPS website under Quality Assurance. "MPS" and "The Future of Analog IC Technology", are Registered Trademarks of Monolithic Power Systems, Inc.



Warning: Although this board is designed to satisfy safety requirements, the engineering prototype has not been agency approved. Therefore, all testing should be performed using an isolation transformer to provide the AC input to the prototype board.

EVHF920-SE-00A EVALUATION BOARD



TOP VIEW

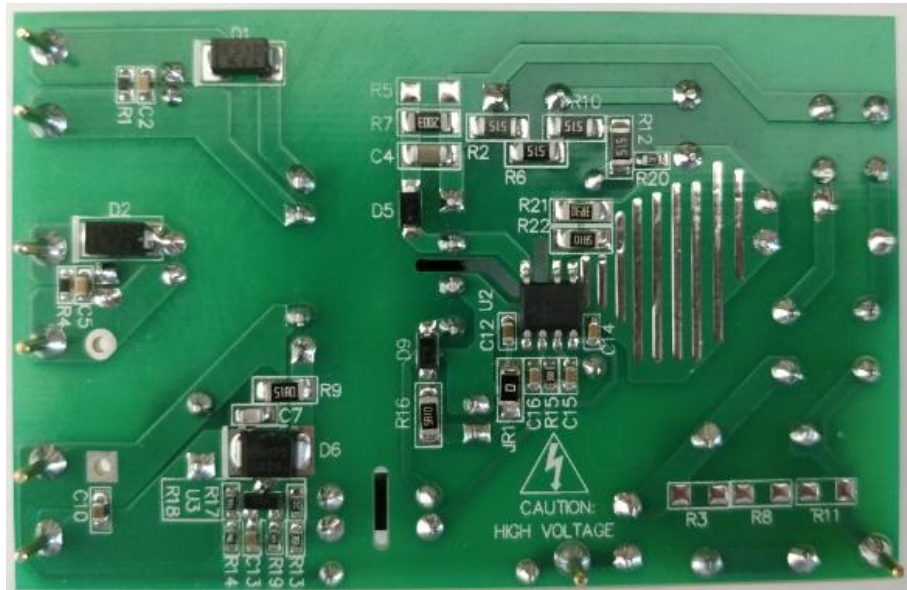

BOTTOM VIEW

(L x W x H) 74mm x 47mm x 22mm

Board Number	MPS IC Number
EVHF920-SE-00A	HF920-SE

EVALUATION BOARD SCHEMATIC

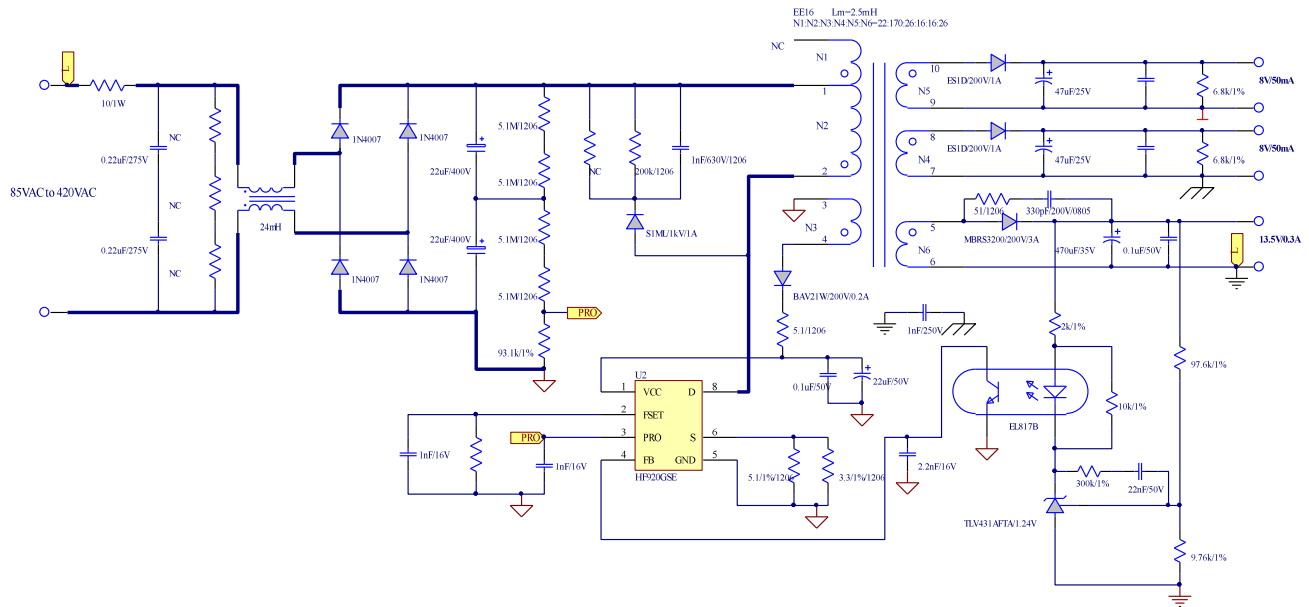

Figure 1—Schematic

EVHF920-SE-00A BILL OF MATERIALS

Qty	Ref	Value	Description	Package	Manufacturer	Manufacturer_P/N
2	C1, C3	47 μ F	Ceramic Capacitor; 25V	DIP	Jianghai	CD28L-25V47
2	C2,C5	1 μ F	Ceramic Capacitor; 25V;X7R	0603	Murata	GRM188R71E2105KA12D
1	C4	1nF	Ceramic Capacitor; 630V;X7R	1206	Murata	GRM31A7U2J102JW31D
2	C6,C8	22 μ F	Electrolytic Capacitor; 400V	DIP	Rubycon	400PX22MEFC12.5X20
1	C7	330pF	Ceramic Capacitor; 200V;COG	0805	Murata	GRM21A5C2D331JW01D
1	C9	470 μ F	Ceramic Capacitor; 35V	DIP	Jianghai	CD263-35V470
2	C10, C12	100nF	Ceramic Capacitor; 50V	0603	Murata	GRM188R71H104KA93D
1	C11	22 μ F	Electrolytic Capacitor; 50V	DIP	Jianghai	CD281L-50V22
1	C13	22nF	Ceramic Capacitor; 50V	0603	Murata	GRM188R71H223KA01D
1	C14	2.2nF	Ceramic Capacitor; 16V	0603	Jianghai	GRM188R71C222KA01D
2	C15, C16	1nF	Ceramic Capacitor; 16V	0603	Jianghai	GRM188R71C102KA01D
2	CX1, CX2	0.22 μ F	X Capacitor; 275V;10%	DIP	Carli	PX224K3IC59H200D9R
1	CY1	1nF	Y Capacitor; 250V;20%	DIP	Hongke	JNK09E102MY02N
2	D1,D2	ES1D	Diode;200V;1A	SMA	Taiwan Semiconductor	ES1D
4	D3, D4, D7,D8	1N4007	Diode;1000V;1A	DO41	Diodes	1N4007
1	D5	S1ML	Diode;1000V;1A;	SMA	Diodes	S1ML
1	D6	MBRS320	Schottky Diode;200V;3A	SMB	Onsemi	MBRS320
1	D9	BAV21W	Diode;200V;0.2A;	SOD123	Diodes	BAV21W
1	LX1	24mH	EE8, Common Choke,	DIP	Emei ⁽¹⁾	FX0344
1	FR1	10	Fuse Resistor;5%;1W	DIP	Yageo	FKN1WSJT-52-10R
2	R1, R4	6.8k	Film Resistor;1%	0603	Yageo	RC0603FR-076K8L
4	R2, R6, R10, R12	5.1M	Film Resistor;5%;1/4W	1206	Yageo	RI1206L515JT
3	R3, R8, R11	2.2M/NC	Film Resistor;5%;1/4W	1206	Royalohm	1206J0225T5E
1	R5	NC				
1	R7	200k	Film Resistor;5%;1/4W	1206	Yageo	RC1206FR-07200KL
1	R9	51	Film Resistor;1%;1/4W	1206	Yageo	RC1206FR-0751RL

EVHF920-SE-00A BILL OF MATERIALS

Qty	Ref	Value	Description	Package	Manufacturer	Manufacturer_P/N
1	R13	2k	Film Resistor;1%	0603	Yageo	RC0603FR-072KL
1	R14	97.6k	Film Resistor;1%	0603	Yageo	RC0603FR-0797K6L
1	R15	200k	Film Resistor;1%	0603	Yageo	RC0603FR-07200KL
1	R17	10k	Film Resistor;1%	0603	Yageo	RC0603FR-0710KL
1	R18	9.76k	Film Resistor;1%	0603	Yageo	RC0603FR-0719K76L
1	R19	300k	Film Resistor;1%	0603	Yageo	RC0603FR-07300KL
1	R20	93.1k	Film Resistor;1%	0603	Yageo	RC0603FR-0793K1L
1	R21	3.3	Film Resistor;1%;1/4W	1206	Yageo	RC1206FR-073R3L
2	R16, R22	5.1	Film Resistor;1%;1/4W	1206	Yageo	RC1206FR-075R1L
1	JR1	0	Film Resistor;1%;1/4W	1206	Yageo	RC1206FR-070RL
1	T1	EE16	EE16, 2.5mH, N1:N2:N3:N4:N5:N6=22 :170:26:16:16:26	DIP	Emei ⁽¹⁾	FX0489
1	U2	HF920	Flyback regulator with 900V integrated MOS	SOIC8-7	MPS	HF920GSE
1	U1	EL817B	Photocoupler;1-Channel	DIP	Everlight	EL817B
1	U3	TLV431	1.24V voltage reference	SOT23	Diodes	TLV431AFTA
Notes:		(1) Emei transformer sample request please login on website: www.emeigroup.com				

EVB TEST RESULTS

Performance waveforms are tested on the evaluation board.

$V_{IN} = 230VAC$, $V_{OUT1} = 13.5V$, $I_{OUT1} = 300mA$, $V_{OUT2} = 8V$, $I_{OUT2} = 50mA$, $V_{OUT2} = 8V$, $I_{OUT2} = 50mA$, $T_A = 25^\circ C$, unless otherwise noted.

Efficiency

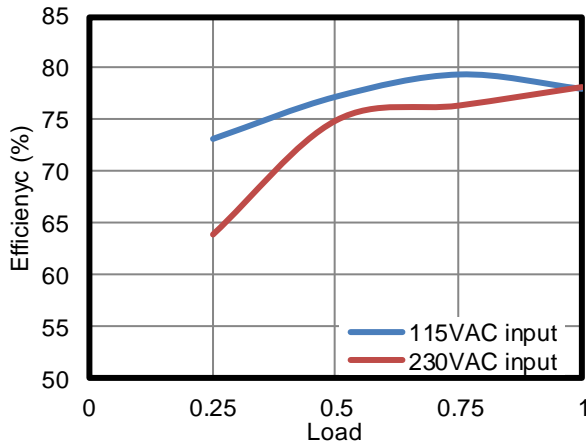

No Load Consumption ⁽¹⁾

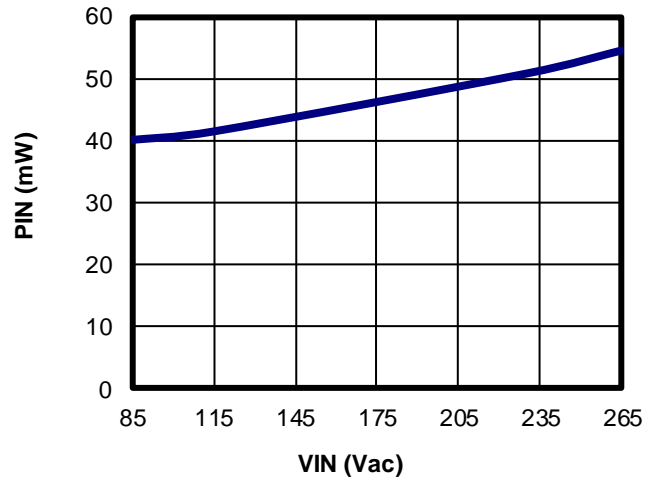

Power On

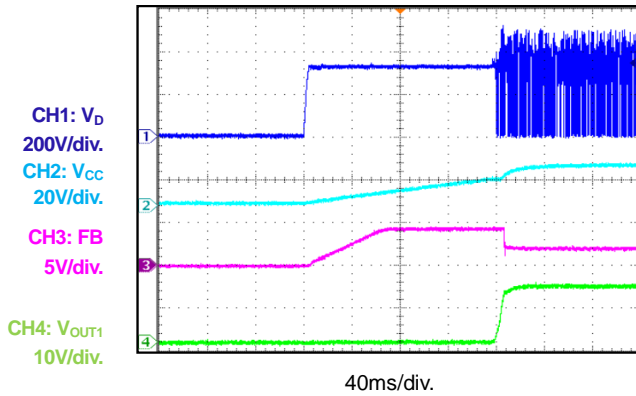

Power Off

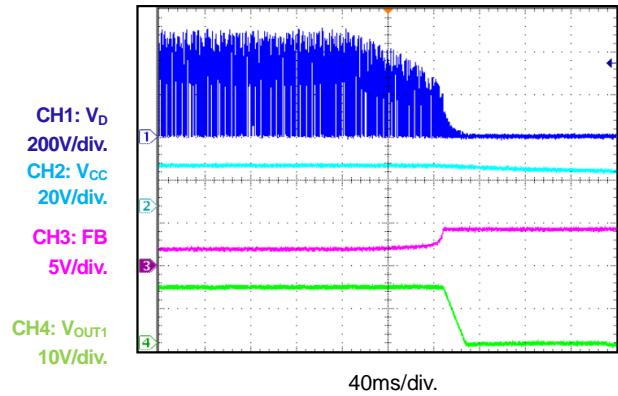

Normal Operation

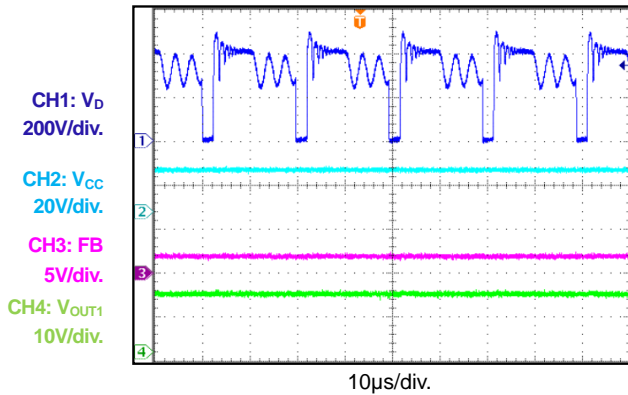

Short Circuit Entry

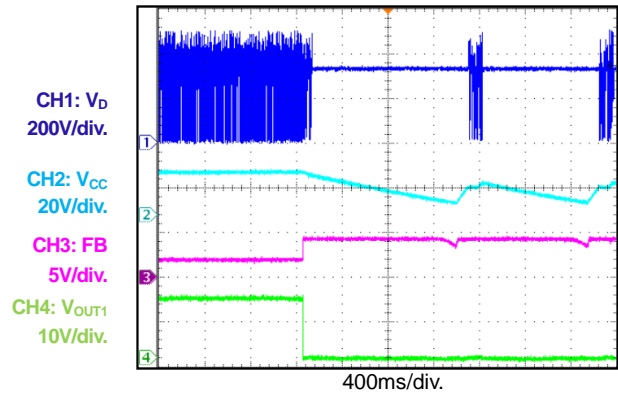

TYPICAL PERFORMANCE CHARACTERISTICS *(continued)*

Performance waveforms are tested on the evaluation board.

 $V_{IN} = 230VAC$, $V_{OUT1} = 13.5V$, $I_{OUT1} = 300mA$, $V_{OUT2} = 8V$, $I_{OUT2} = 50mA$, $V_{OUT2} = 8V$, $I_{OUT2} = 50mA$, $T_A = 25^{\circ}C$, unless otherwise noted.

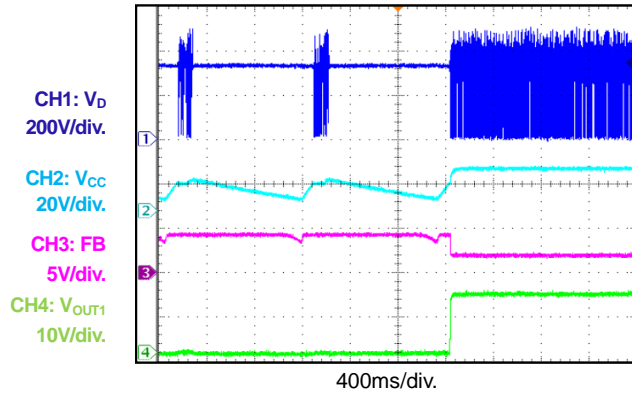
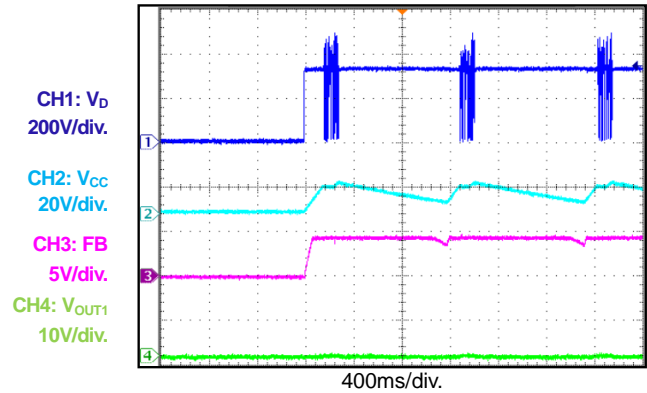
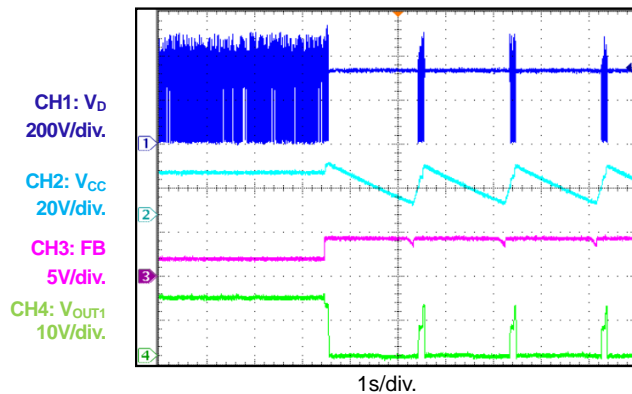
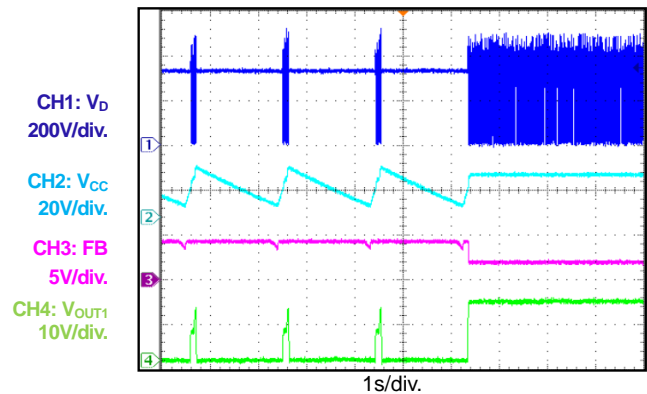
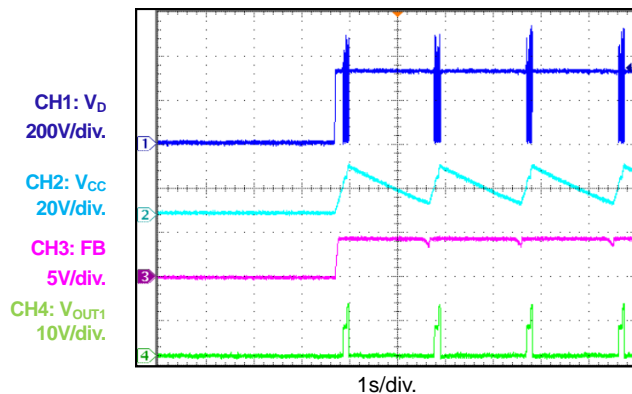
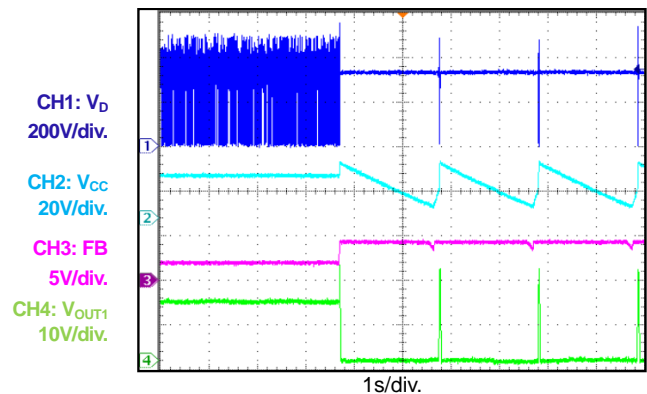
Short Circuit Recovery

Short Circuit Power On

OLP Entry

OLP recovery

OLP Power On

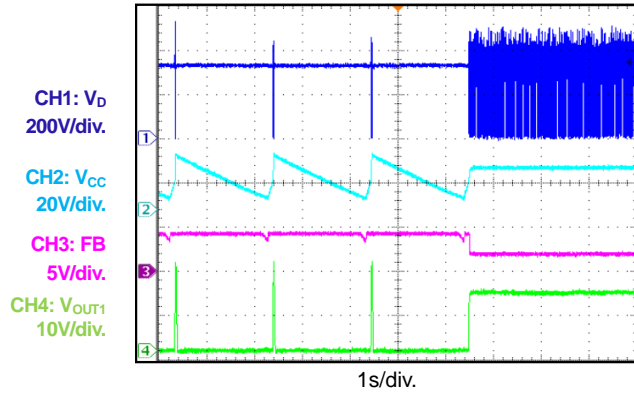
OVP entry

TYPICAL PERFORMANCE CHARACTERISTICS *(continued)*

Performance waveforms are tested on the evaluation board.

$V_{IN} = 230VAC$, $V_{OUT1} = 13.5V$, $I_{OUT1} = 300mA$, $V_{OUT2} = 8V$, $I_{OUT2} = 50mA$, $V_{OUT3} = 8V$, $I_{OUT3} = 50mA$, $T_A = 25^{\circ}C$, unless otherwise noted.

OVP Recovery



OVP Power On

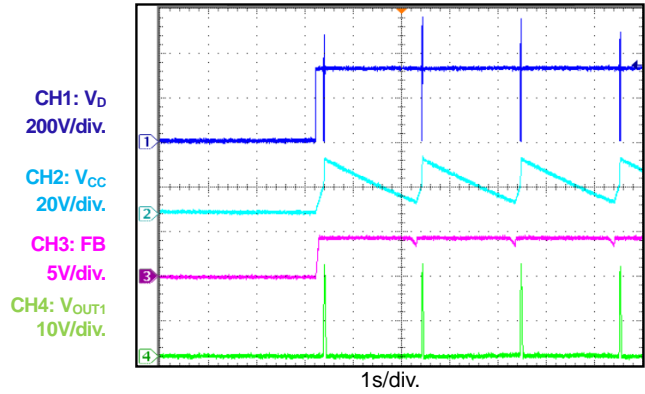

Conducted EMI
Two-Wire Input, L Line

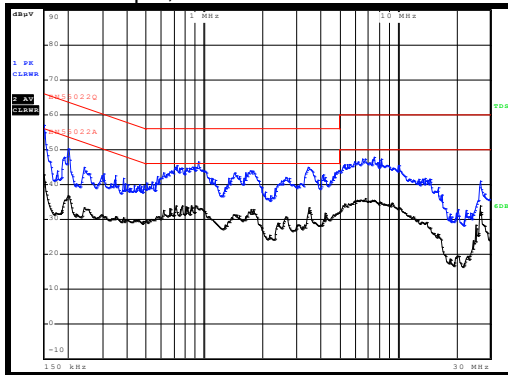

Conducted EMI
Two-Wire Input, N Line

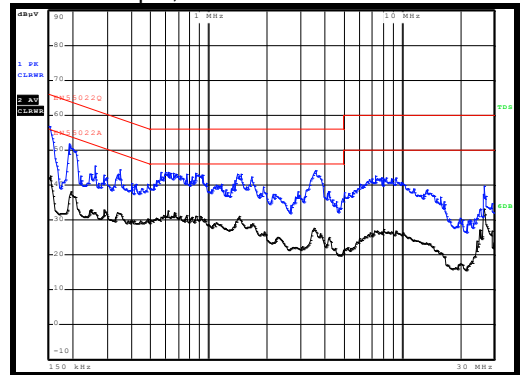

Note: 1) The no load consumption can achieve $< 30mW$ with OUT2 and OUT3 open.

PCB LAYOUT (SINGLE-SIDED)

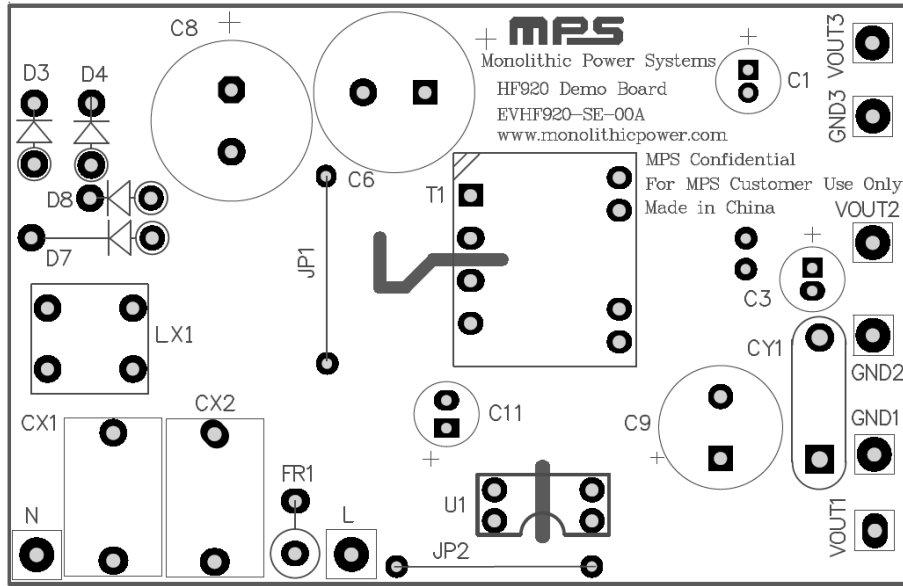

Figure 2—Top Layer

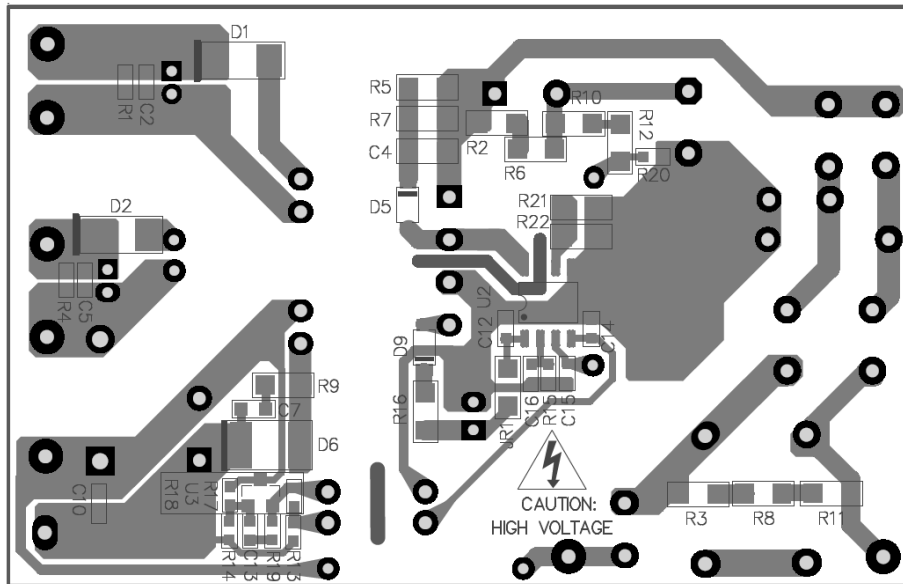

Figure 3—Bottom Layer

TRANSFORMER SPECIFICATION

Electrical Diagram

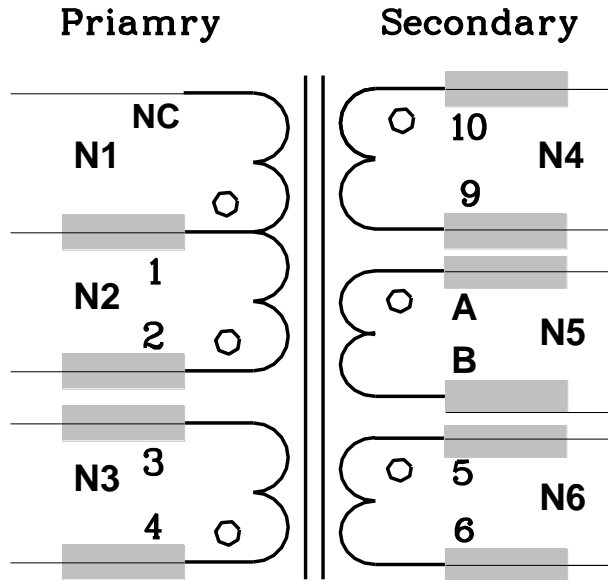

Figure 4—Transformer Electrical Diagram

Notes:

1. All winding terminals are added tube;
2. N5 is flying out from the bobbin. Terminal A is labeled with black and terminal B is labeled with white;
3. Remove Pin7 and Pin8;
4. Varnish the transformer.

Winding Diagram

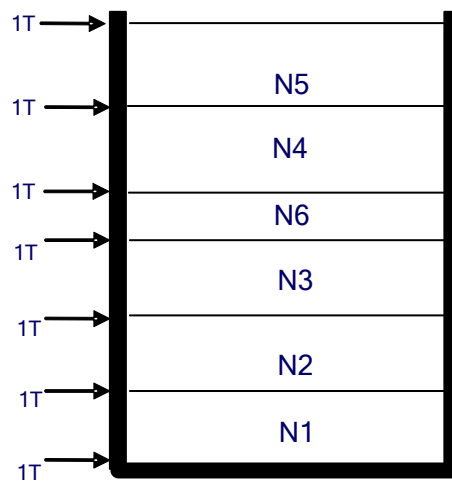

Figure 5—Winding Diagram

Winding Order

Winding No.	Tape Layer No.	Start & End	Magnet Wire ϕ (mm)	Turns
N1	1	1—> NC	0.15mm*2	22
N2	1	2—> 1	0.15mm*1	170
N3	1	4—> 3	0.10mm*1	26
N6	1	5—> 6	0.30mm*1 TIW	26
N4	1	10—> 9	0.16mm*1 TIW	16
N5	1	A—> B	0.16mm*1 TIW	16

Electrical Specifications

Electrical Strength	60 second, 60Hz, from PRI. to SEC.	4500VAC
	60 second, 60Hz, from N4 to N6.	4500VAC
	60 second, 60Hz, from PRI. to CORE	2500VAC
Primary Inductance	Pins 1-2, all other windings open, measured at 60kHz, 0.1VRMS	2.5mH \pm 5%

Materials

Item	Description
1	Core: EE16, UI=2300 \pm 25%, AL=1100nH/N ² \pm 25% UNGAPPED
2	Bobbin: EE16 Vertical, 4+6PIN 1SECT T-H
3	Wire: Φ 0.15mm, 2UEW, Class B
4	Wire: Φ 0.10mm, 2UEW, Class B
5	Triple Insulation Wire: Φ 0.30mm TIW
6	Triple Insulation Wire: Φ 0.16mm TIW
7	Tape: 8.5mm(W) x0.06mm(TH)
8	Tube: #26 BLACK; #26 CLEAR; #30 CLEAR; #23 CLEAR
9	Varnish: JOHN C. DOLPH CO, BC-346A or equivalent
10	Solder Bar: CHEN NAN: SN99.5/Cu0.5 or equivalent

CIRCUIT DESCRIPTION

The EVHF920-SE-00A is configured for 5W triple outputs in power meter application. The 8V output rail can power the LCD for MCU power supply. The demo board is proper for three phase input power system.

FR1 is used to protect for the component failure or some excessive short events, also it can restrain the inrush current.

The CX1, CX2 and LX1 compose the EMI filter to guarantee the conducted EMI meet the EN55022 criteria. CX1 is in series with CX2 for 420VAC input.

D3, D4, D7 and D8 compose the input stage to commute the AC voltage to DC voltage.

The C6 and C8 are used for energy storage reducing line noise and protecting against line surge. R2, R6, R10, R12 and R20 are for balancing the voltage of C6 and C8 and also configured for input over voltage protection.

R7, C4 and D5 are formed the RCD to restrain the high voltage spike to protect the MOSFET.

R15 is for switching frequency setup. Normally, the switching frequency is configured low to get good thermal performance under high voltage

input applications. And switching frequency should be far away from data sampling frequency in power meter applications to avoid noise disturbing. C16, typically 1nF, is used for double frequency mode selection.

C11 is the power supply capacitor and C12 is the decoupling ceramic cap to decouple the voltage noise spike. C12 should be located near to IC.

R21, R22 are the sense resistors with 1% tolerance for peak current setup.

C1, C3, C9 are the output filter capacitor to restrain the output voltage ripple. One filter could be used for strict voltage ripple requirement.

R1, R4 are dummy load to regulate the output voltage within designed value.

R14, R18 are configured to set the output voltage. U1, U3, R19 and C13 compose the control loop to feedback the output signal to FB pin and guarantee the quick control loop response and system stability.

Input Line wire is connected to GND of main output for input AC frequency sample in power meter.

QUICK START GUIDE

1. Preset power supply to $85\text{VAC} \leq V_{\text{IN}} \leq 420\text{VAC}$.
2. Turn power supply off.
3. Connect the Line and Neutral terminals of the power supply output to L and N port.
4. Connect different loads to corresponding outputs :
 - a. Positive (+): VOUTX
 - b. Negative (-): GNDX
5. Turn power supply on after making connections.

NOTICE: The information in this document is subject to change without notice. Please contact MPS for current specifications. Users should warrant and guarantee that third party Intellectual Property rights are not infringed upon when integrating MPS products into any application. MPS will not assume any legal responsibility for any said applications.