

## DESCRIPTION

The EVHFC0310-S-00A is an evaluation board for the HFC0310. It is configured to provide a regulated 12V output at up to 0.6A load current, and 6V output at up to 0.1A load current from a 85V<sub>AC</sub> - 420V<sub>AC</sub> input.

HFC0310 uses peak current mode to provide excellent transient response and ease loop compensation. When the output power falls below a given level, the controller enters burst mode to lower the stand-by power consumption.

An external capacitor connected between the FSET pin and GND programs the HFC0310 switching frequency. Otherwise, the HFC0310 uses a frequency shaping function that greatly reduces the noise level, and reduces the cost of the EMI filter.

## ELECTRICAL SPECIFICATION

Parameter	Symbol	Value	Units
Input voltage	V <sub>IN</sub>	85 – 420	V <sub>AC</sub>
Output1 voltage	V <sub>OUT1</sub>	12	V
Output1 current	I <sub>OUT1</sub>	0.6	A
Output2 voltage	V <sub>OUT2</sub>	6	V
Output2 current	I <sub>OUT2</sub>	0.1	A

## FEATURES

- Programmable switching frequency up to 600kHz
- Frequency shaping ( $\pm 3.5\%$ )
- Current-mode operation
- Very low start-up current (12 $\mu$ A)
- Very low standby power consumption via active-burst mode
- Internal 350ns leading-edge blanking
- Built-in 3ms soft-start function
- Internal slope compensation
- Built-in PRO pin pull-up (>3.25V) auto-restart function

## APPLICATIONS

- Power Meters
- Switching Mode Power Supplies
- AC/DC Adapters, Switching Chargers

All MPS parts are lead-free and adhere to the RoHS directive. For MPS green status, please visit MPS website under Quality Assurance.

"MPS" and "The Future of Analog IC Technology" are Registered Trademarks of Monolithic Power Systems, Inc.

## EVHFC0310-S-00A EVALUATION BOARD



(L x W x H) 103mm x 52mm x 35mm

Board Number	MPS IC Number
EVHFC0310-S-00A	HFC0310

### Efficiency

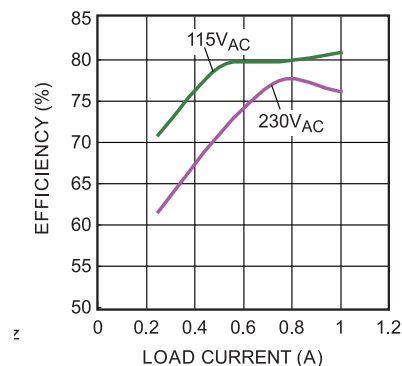

## EVALUATION BOARD SCHEMATIC

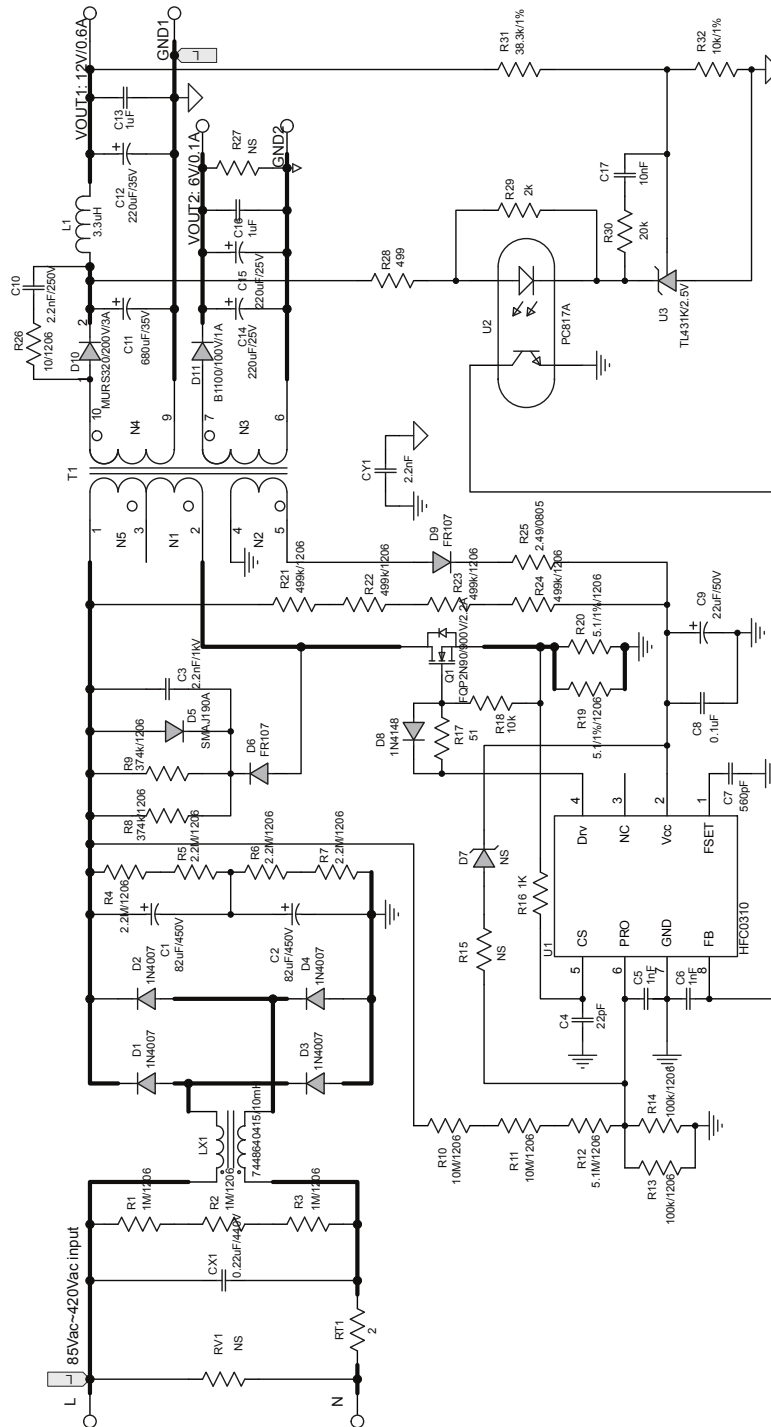

**EVHFC0310-S-00A BILL OF MATERIALS**

Qty	Ref	Value	Description	Package	Manufacturer	Manufacturer P/N
2	C1,C2	82µF	Electrolytic Cap, 450V	DIP	Jianghai	CD266-450V82uF
1	C3	2.2nF	Film Cap, 1kV	DIP	Any	Any
1	C4	22pF	Ceramic Cap, 50V, C0G	0603	Murata	GRM1885C1H220JA01
2	C5,C6	1nF	Ceramic Cap, 50V, X7R	0603	TDK	C1608X7R1H102K
1	C7	560pF	Ceramic Cap, 50V, C0G	0603	TDK	C1608C0G1H561K
1	C8	0.1µF	Ceramic Cap, 50V, X7R	0603	Murata	GRM188R71H104KA93D
1	C9	22µF	Electrolytic Cap, 50V	DIP	Jianghai	CD281L-50V22
1	C10	2.2nF	Ceramic Cap, 250V, X7R	0805	TDK	C2012X7R2E222K
1	C11	680µF	Electrolytic Cap, 35V	DIP	Jianghai	CD287-35V680
1	C12	220µF	Electrolytic Cap, 35V	DIP	Jianghai	CD287-35V220
2	C13,C16	1µF	Ceramic Cap, 50V, X7R	0805	TDK	C2012X7R1E105K
2	C14,C15	220µF	Electrolytic Cap, 25V	DIP	Panasonic	220uF/25V
1	C17	10nF	Ceramic Cap, 50V, X7R	0603	Murata	GRM188R71H103KA01D
1	CX1	0.22µF	Film Cap, 440Vac, X1	DIP	Faratronic	MKP65-224K
1	CY1	2.2nF	Film Cap, 4000V, Y1	DIP	Hongke	JN12E222MY02N
3	R1,R2,R3	1MΩ	Film Res., 1%	1206	Yageo	RC1206FR-071ML
4	R4,R5,R6, R7	2.2MΩ	Film Res., 5%	1206	Any	Any
2	R8,R9	374kΩ	Film Res., 1%	1206	Yageo	RC1206FR-07374KL
2	R10,R11	10MΩ	Film Res., 1%	1206	Royalohm	1206F1005T5E
1	R12	5.1MΩ	Film Res., 5%	1206	Yageo	RI1206L515JT
2	R13,R14	100kΩ	Film Res., 5%	1206	Yageo	RM12JTN104
1	R15	NS				
1	R16	1kΩ	Resistor, 1%	DIP	Any	Any
1	R17	51Ω	Film Res., 1%	0603	Yageo	RC0603FR-0751RL
2	R18,R32	10kΩ	Film Res., 1%	0603	Yageo	RC0603FR-0710KL
2	R19,R20	5.1Ω	Film Res., 1%	1206	Yageo	RC1206FR-075R1L
4	R21,R22, R23, R24	499k	Film Res., 1%	1206	Royalohm	RC1206FR-07499KL
1	R25	2.49Ω	Film Res., 1%	0805	Yageo	RC0805FR-072R49L

**EVHFC0310-S-00A BILL OF MATERIALS (continued)**

Qty	Ref	Value	Description	Package	Manufacturer	Manufacturer P/N
1	R26	10Ω	Film Res., 5%	1206	Yageo	RC1206JR-0710R
1	R27	NS				
1	R28	499Ω	Film Res., 1%	0603	Yageo	RC0603FR-07499RL
1	R29	2kΩ	Film Res., 1%	0603	Yageo	RC0603FR-072KL
1	R30	20kΩ	Film Res., 1%	0603	Yageo	RC0603FR-0720KL
1	R31	38.3kΩ	Film Res., 1%	0603	Yageo	RC0603FR-0738K3L
4	D1,D2, D3,D4	1N4007	Diode, 1A/1000V	DO41	Diodes	1N4007
1	D5	SMAJ190A	Diode, 1mA/190V	SMA	Brightking	SMAJ190A
2	D6,D9	FR107	Diode, 1A/1000V	DO41	Diodes	FR107
1	D7	NS				
1	D8	1N4148	Diode, 0.2A/75V	SOD323	Diodes	IN4148
1	D10	MURS320T3	Diode, 3A/200V	SMC	ON Semiconductor	MURS320T3
1	D11	B1100	Diode, 1A/100V	SMA	Diodes	B1100-13-F
1	Q1	FQP2N90	N-Channel Mosfet,2.2A/900V	TO220	Fairchild	FQP2N90
1	RT1	2Ω	NTC Res;	DIP	Xingshun	2D2-10
1	L1	3.3μH	Inductor, 2.66A	DIP	TOKO	8RHB2#822LY3R3M
1	LX1	10mH	Common filter	DIP	Würth	7448640415
1	T1		EF20, Primary Inductance: 2.5mH, N1:N2:N3:N4:N5=46: 12:12:6:46	DIP	Any	Any
1	RV1	NS				
1	U1	HFC0310	HFC0310GS	SOIC8	MPS	HFC0310GS
1	U2	PC817A	Opto-coupler	DIP	Sharp	PC817A
1	U3	TL431K	Shunt Regulator 2.5V	SOT-23	TI	TL431K

## TRANSFORMER STRUCTURE

Electrical Diagram

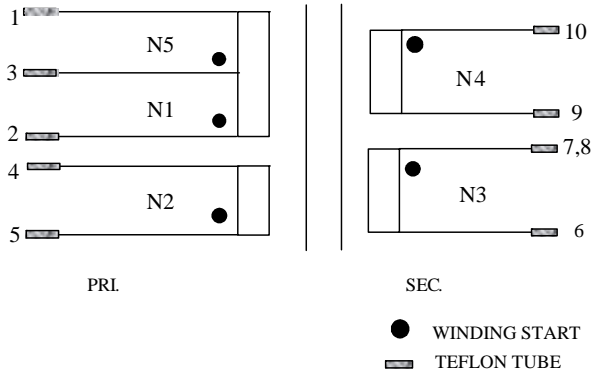

Winding Diagram

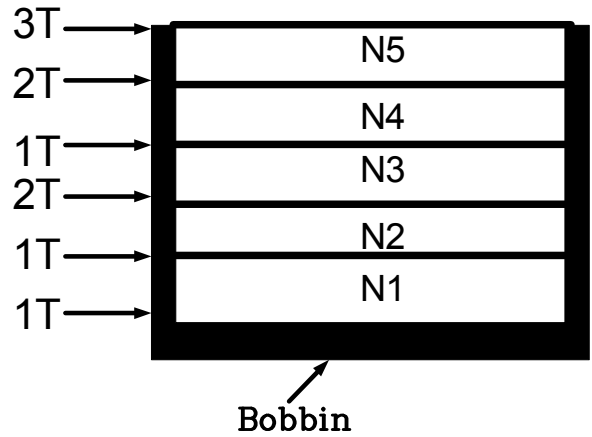

### Pin Definition of Bobbin

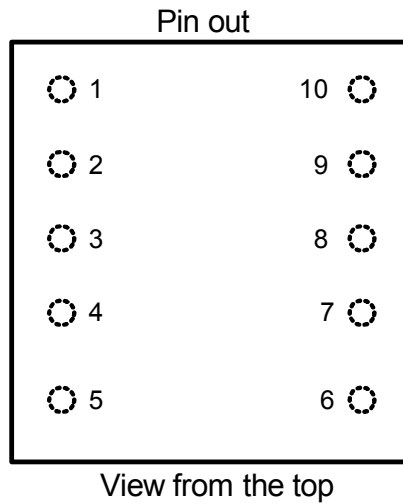

**Table 1—Electrical Characteristic**

Parameter	Condition	Value
Primary Inductance	Lp(2-1)	2.5mH±5%
Core	/	EF20
Bobbin	/	EF20
Core Material	/	PC40or equivalent
Turn Ratio	N1:N2:N3:N4:N5	46:12:12:6:46

**Table 2—Winding Specification**

Tape Turns	Winding No.	Margin Tapes	Start&End	Wire Diameter (mm)	Turns
1	N1	2mm	2→3	0.2×1	46
2	N2	2mm	5→4	0.2×1	12
1	N3	/	7,8→6	0.5T.I.W.×1	12
2	N4	/	10→9	0.29T.I.W.×1	6
3	N5	2mm	3→1	0.2×1	46

## EVB TEST RESULTS

Performance waveforms are tested on the evaluation board.

$V_{IN} = 230V_{AC}$ ,  $V_{OUT1} = 12V/0.6A$ ,  $V_{OUT2} = 6V/0.1A$ ,  $T_A = 25^{\circ}C$ , unless otherwise noted.

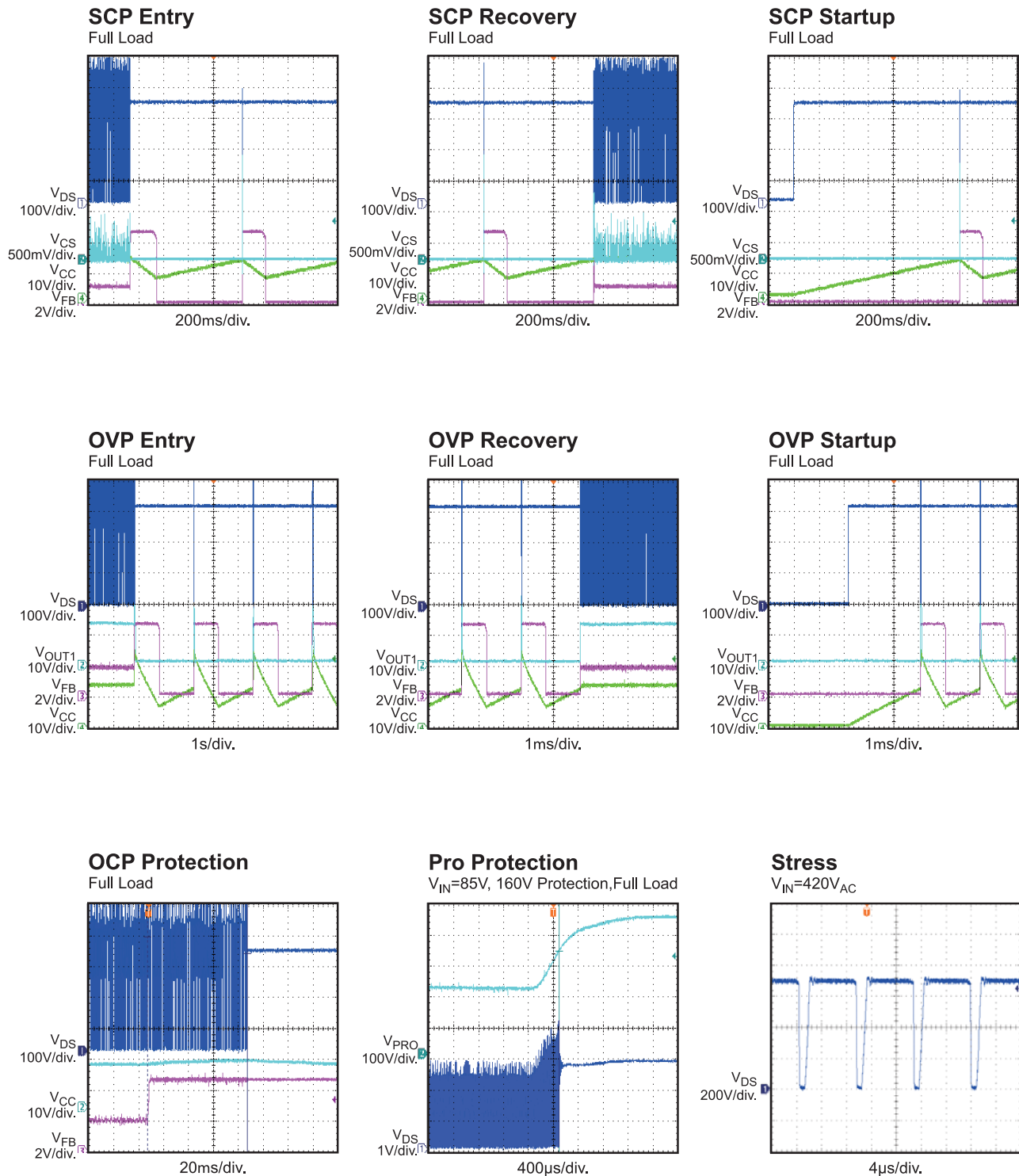

## EVB TEST RESULTS *(continued)*

Performance waveforms are tested on the evaluation board.

$V_{IN} = 230V_{AC}$ ,  $V_{OUT1} = 12V/0.6A$ ,  $V_{OUT2} = 6V/0.1A$ ,  $T_A = 25^{\circ}C$ , unless otherwise noted.

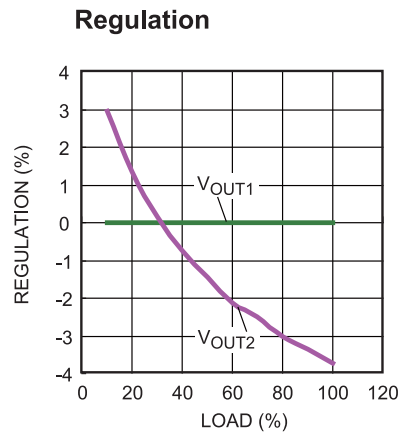
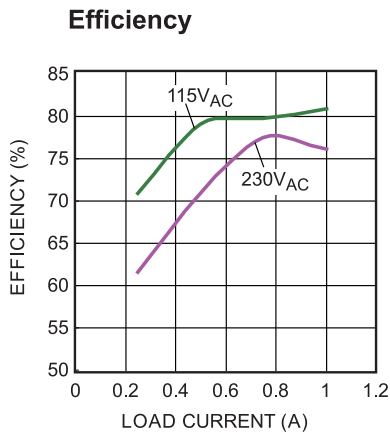
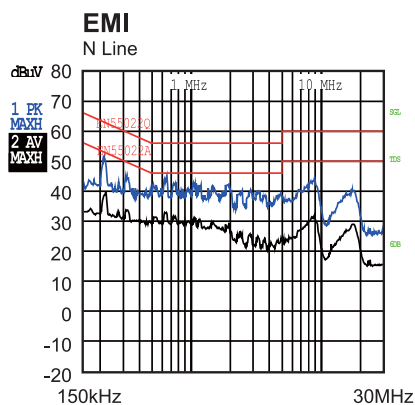
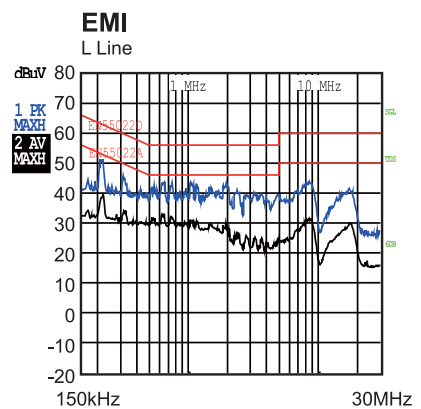
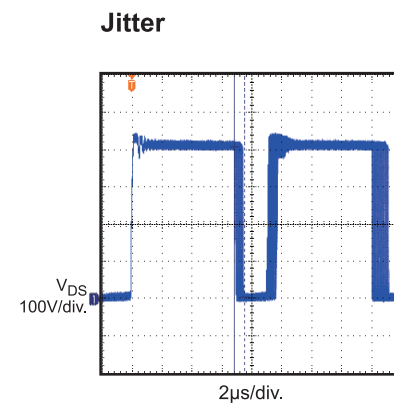
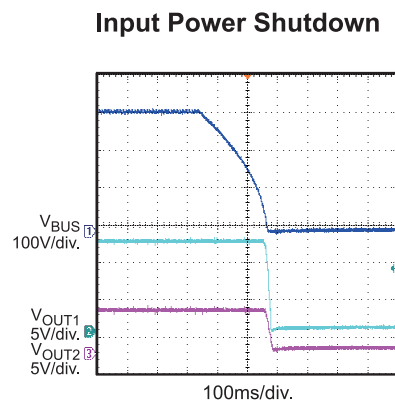
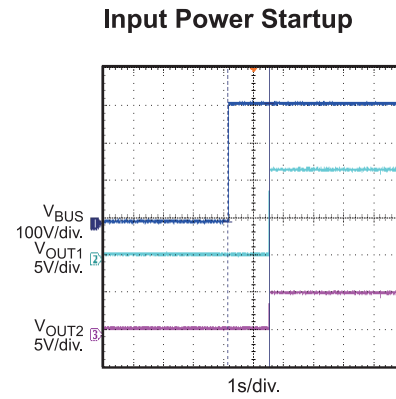
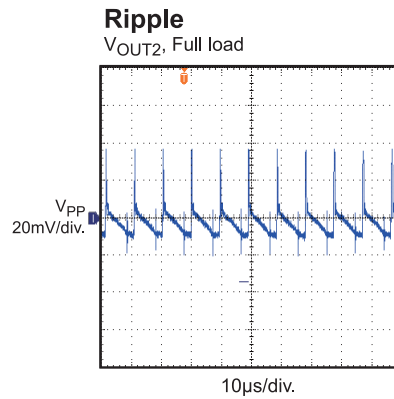
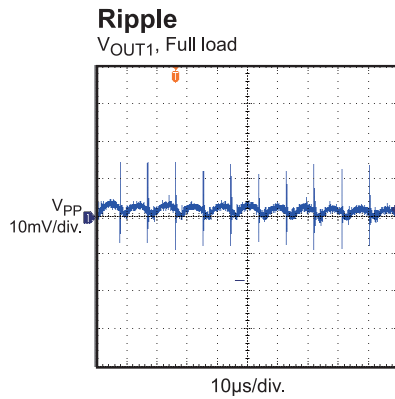



### PRINTED CIRCUIT BOARD LAYOUT

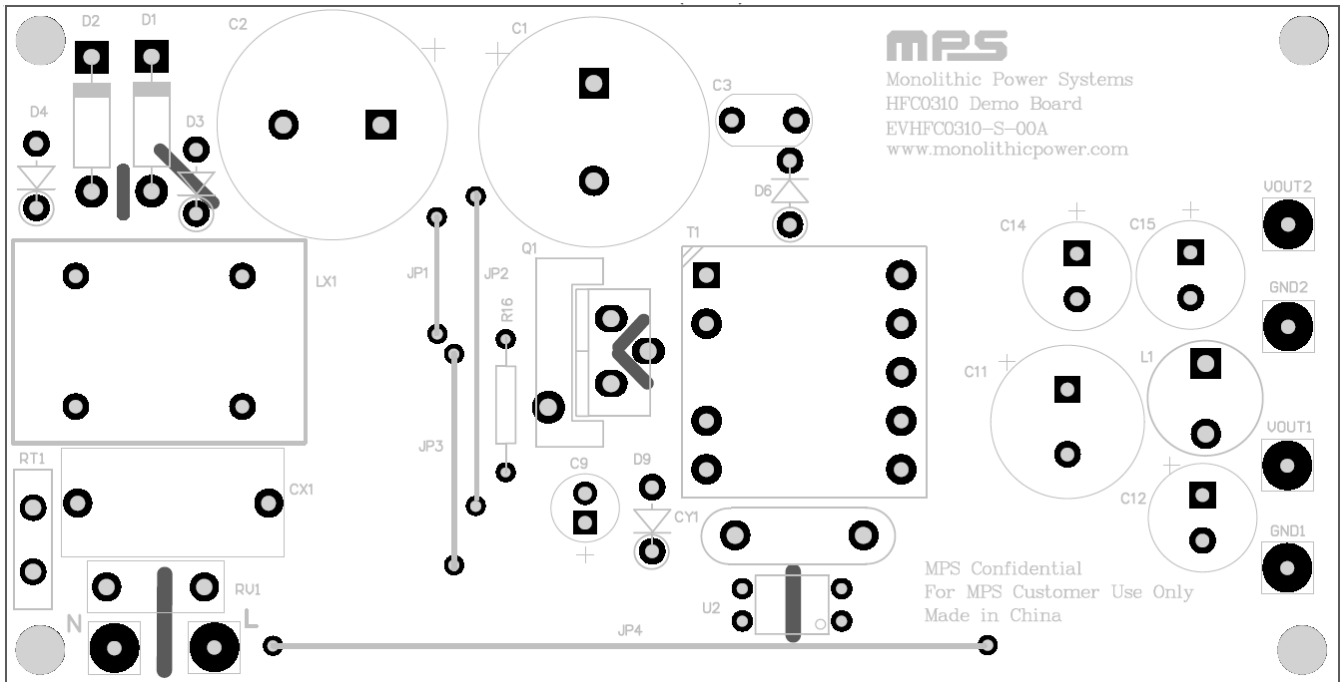

Figure 1—Top Layer

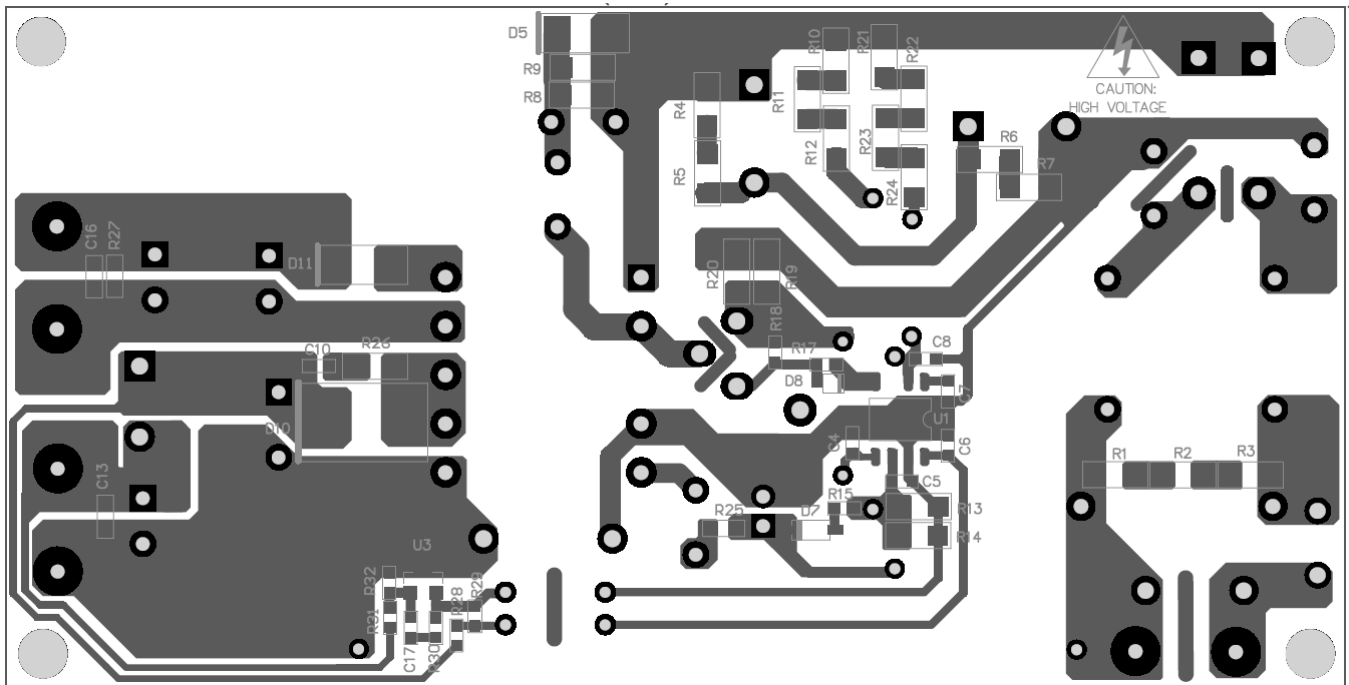

Figure 2—Bottom Layer

## QUICK START GUIDE

1. Preset Power Supply to  $85V_{AC} \leq V_{IN} \leq 420V_{AC}$ .
2. Turn Power Supply off.
3. Connect Power Supply terminals to Line and Neutral
4. Connect Load to  $V_{OUT1}$  and GND1,  $V_{OUT2}$  and GND2
5. Turn Power Supply on. The board will automatically startup.

**NOTICE:** The information in this document is subject to change without notice. Users should warrant and guarantee that third party Intellectual Property rights are not infringed upon when integrating MPS products into any application. MPS will not assume any legal responsibility for any said applications.