



EVHR1203-Y-00A

240W General-Purpose Evaluation Board

DESCRIPTION

The EVHR1203-Y-00A is a general-purpose evaluation board for the HR1203 for 240W PC and ATX power, adapters, all-in-one or gaming power, and general AC/DC power supply applications.

The HR1203 integrates a digital PFC controller and a half-bridge resonant controller into a single chip. It uses very low power at no load or ultra-light load, making it compliant with Energy Using Product Directive (EuP) Lot 6 and Code of Conduct Version 5 Tier 2 specifications.

The PFC of the HR1203 employs a patented average current control scheme, which can operate in continuous conduction mode (CCM) and discontinuous conduction mode (DCM), according to the instantaneous condition of the input voltage and output load. The IC exhibits excellent efficiency and a high power factor (PF) at light load.

The half-bridge LLC converter achieves high efficiency with zero-voltage switching (ZVS). The HR1203 implements an adaptive dead-time adjustment (ADTA) function so the LLC converter can easily achieve ZVS from heavy load to light load. Additionally, the HR1203 can prevent the LLC converter from operating in capacitive mode, making it more robust and easier to design.

Typically, the EVHR1203-Y-00A is designed for PC and ATX power, adapters, and gaming power applications with a 12V, 20A constant voltage output and 240W rated power from 90V_{AC} to 265V_{AC} and 50Hz/60Hz.

The EVHR1203-Y-00A has excellent efficiency and a high power factor for the entire load range. Full protection features include overload protection, short-circuit protection (SCP), over-voltage protection (OVP), and anti-capacitive mode protection. The EVHR1203-Y-00A also meets the Class C standard of IEC61000-3-2 and the EN55022 standard.

ELECTRICAL SPECIFICATIONS

Parameter	Symbol	Value	Units
Input AC voltage	V _{IN_AC}	90 to 265	V
Output current	I _{OUT}	20	A
Output voltage	V _{OUT}	12	V
Output power	P _{OUT}	240	W

FEATURES

- Wide Operating Input Range (from 90V to 265V)
- 240W Rated Power and Constant Voltage Output
- High Efficiency Up to 93%
- Meets EuP Lot 6 and COC Version 5 Tier 2 Specifications
- Meets Class C Standard of IEC61000-3-2
- Meets EN55022 Standard
- Meets EN61000-4-5 Level 4 for Surge Immunity (4kV)
- High Power Factor (PF)
- Overload Protection (Auto-Restart Mode)
- Short-Circuit Protection (SCP) (Auto-Restart Mode)
- Over-Voltage Protection (OVP)
- Anti-Capacitive Mode Protection

APPLICATIONS

- PC and ATX Power
- Adapters
- All-in-One or Gaming Power Supplies
- General AC/DC Power Supply

All MPS parts are lead-free, halogen-free, and adhere to the RoHS directive. For MPS green status, please visit the MPS website under Quality Assurance. "MPS", the MPS logo, and "Simple, Easy Solutions" are trademarks of Monolithic Power Systems, Inc. or its subsidiaries.



High Voltage

Warning: Although this board is designed to satisfy safety requirements, the engineering prototype has not been agency approved. Therefore, all testing should be performed using an isolation transformer to provide AC input to the prototype board.

EVHR1203-Y-00A EVALUATION BOARD

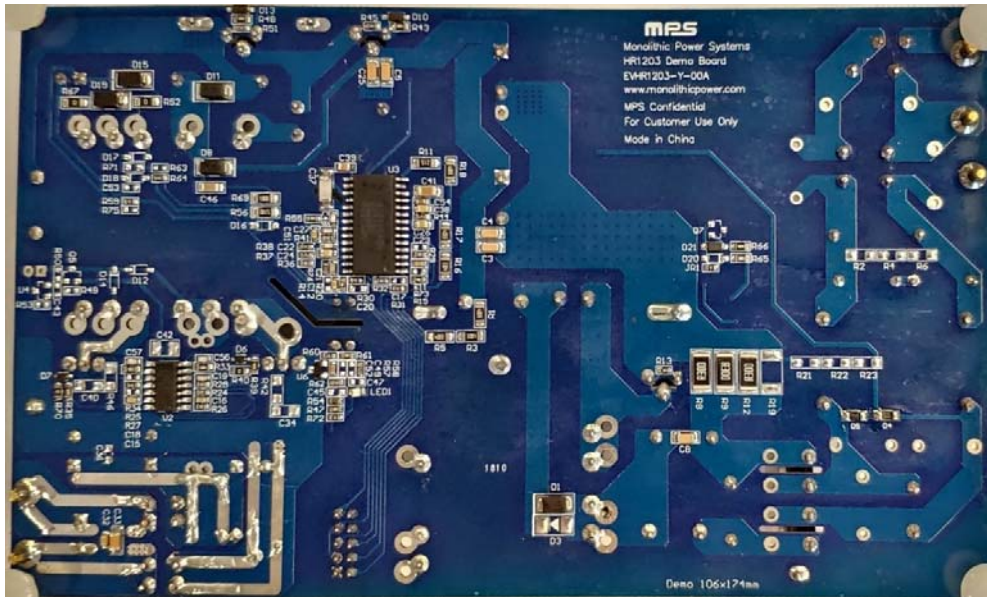
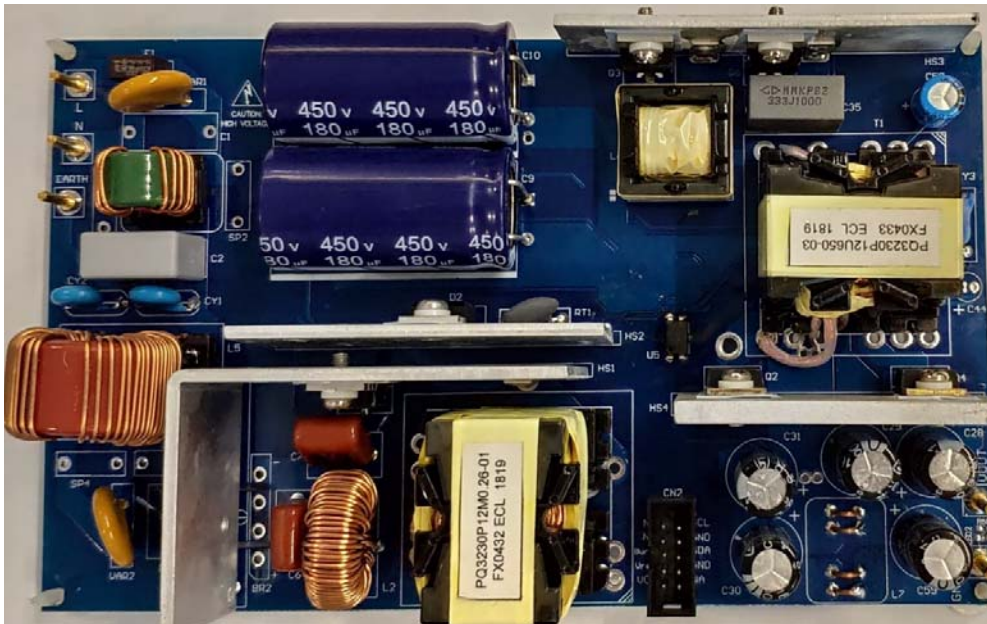

(LxWxH) (17.4cmx10.55cmx3.5cm)

Board Number	MPS IC Number
EVHR1203-Y-00A	HR1203GY
	MP6922DS

EVALUATION BOARD SCHEMATIC

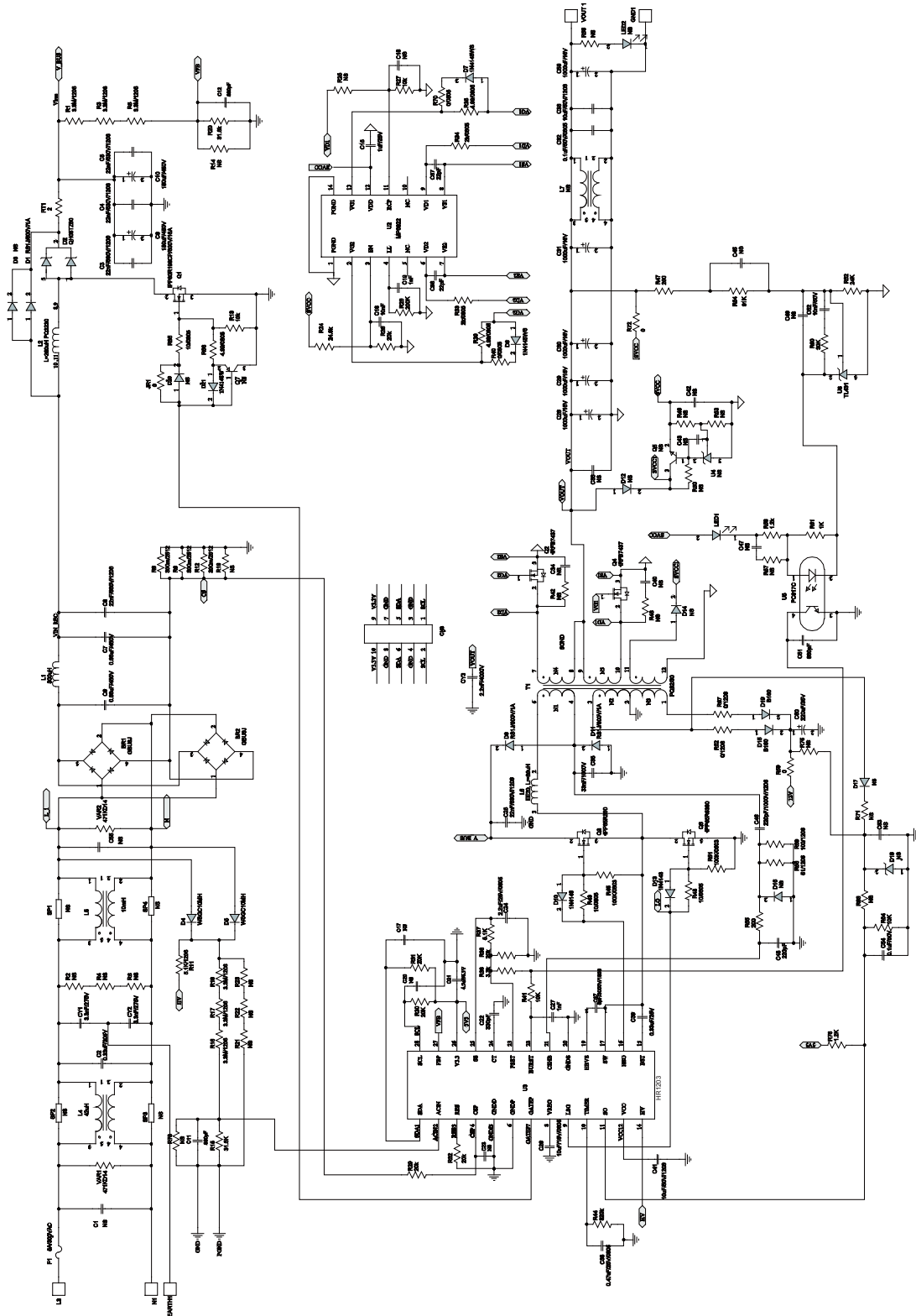

EVHR1203-Y-00A BILL OF MATERIALS

Qty	Ref	Value	Description	Package	Manufacturer	Manufacturer P/N
2	CY1, CY2	3.3nF	Y capacitor, 2600V, 20%	DIP	HongKe	JYK10F332MY72N
1	CY3	2.2nF	Y capacitor, 4000V, 20%	DIP	HongKe	JNK12E222MY02N
5	C28, C29, C30, C31, C59	1000µF	Electrolytic capacitor, 16V	DIP	JIANGHAI	C287-16V1000
1	C2	0.33µF	X-capacitor, 310V	DIP	VISHAY	BFC233920334
2	C6, C7	0.68µF	Capacitor, 450V, CBB	DIP	CARLI	TF684K2Y10BL270D9R
5	C3, C4, C5, C8, C25	22nF	Ceramic capacitor, 630V, X7R	1206	TDK	
1	C15	1µF	Ceramic capacitor, 25V, X7R	0603	Murata	GRM188R71E105KA12D
2	C9, C10	180µF	Electrolytic capacitor, 450V	DIP	JIANGHAI	CD263-450V180
3	C11, C12, C51	680pF	Ceramic capacitor, 50V, X7R	0603	Murata	GRM188R71H681KA01D
2	C19, C27	1nF	Ceramic capacitor, 50V, X7R	0603	Murata	GRM188R71H102KA01D
1	C54	0.1µF	Ceramic capacitor, 50V, X7R	0603	Murata	GRM188R71H104KA93D
1	C39	0.33µF	Ceramic capacitor, 50V, X7R	0805	TDK	C2012X7R1H334K
1	C22	330pF	Ceramic capacitor, 50V, COG	0603	TDK	C1608COG1H331D
1	C48	220pF	Ceramic capacitor, 50V, COG	0603	Murata	GMR1885C1H221JA01D
1	C37	5pF	Ceramic capacitor, 3000V, NP0	1808	HHEC	C1808N5R0J302T
2	C16, C52	10nF	Ceramic capacitor, 50V, X7R	0603	Murata	GRM188R71H103KA01D
1	C21	4.7µF	Ceramic capacitor, 6.3V, X5R	0603	TDK	C1608X5R0J475K
1	C32	0.1µF	Ceramic capacitor, 50V, X7R	0805	TDK	C2012X7R1H104K
1	C35	33nF	Capacitor, 1000V	DIP	FaLa	MMKP82-1000V-333P15JA
1	C38	0.47µF	Ceramic capacitor, 25V, X7R	0805	Murata	GMR21BR71E474KA01L
2	C33, C41	10µF	Ceramic capacitor, 50V, X5R	1206	Murata	GRM31CR61H106KA12L
1	C26	10µF	Ceramic capacitor, 16V, X7R	0805	Murata	GMR21BR61C106KE15
1	C46	220pF	Ceramic capacitor, 1000V, U2J	1206	Murata	GMR31A7U3A221JW31D
1	C50	220µF	Electrolytic capacitor, 35V	DIP	JIANGHAI	CD110-35V220
1	C24	2.2µF	Ceramic capacitor, 25V, X7R	0805	Murata	GRM21BR71E225KA73L

EVHR1203-Y-00A BILL OF MATERIALS (continued)

Qty	Ref	Value	Description	Package	Manufacturer	Manufacturer P/N
2	C56, C57	22pF	Ceramic capacitor, 50V, COG	0603	TDK	C1608COG1H220J
3	R35, R39, R66	4.99Ω	Film resistor, 1%	0805	Yageo	RC0805FR-074R99L
6	R26, R29, R30, R31, R32, R36	20kΩ	Film resistor, 1%	0603	Yageo	RC0603FR-0720KL
6	R1, R3, R5, R16, R17, R18	3.3MΩ	Film resistor, 1%	1206	Yageo	RC1206FR-073M3L
1	R11	5.1kΩ	Film resistor, 1%	1206	Yageo	RC1206FR-075K1L
2	R33, R34	4.99kΩ	Film resistor, 1%	0805	Yageo	RC0805FR-074K99L
2	R58, R76	1.2kΩ	Film resistor, 1%	0603	Yageo	RC0603FR-071K2L
3	R28, R45, R51	100kΩ	Film resistor, 1%	0603	Yageo	RC0603FR-07100KL
1	R24	24.9kΩ	Film resistor, 1%	0603	Yageo	RC0603FR-0724K9L
3	R43, R48, R65	10Ω	Film resistor, 1%	0805	Yageo	RC0805FR-0710RL
1	R60	30kΩ	Film resistor, 1%	0603	Yageo	RC0603FR-0730KL
3	R8, R9, R12	0.3Ω	Film resistor, 1%	2512	Yageo	RL2512FK-070R3L
1	R37	5.1kΩ	Film resistor, 1%	0603	Yageo	RC0603FR-075K1L
4	R13, R27, R41, R64	10kΩ	Film resistor, 1%	0603	Yageo	RC0603FR-0710KL
2	R15, R20	31.6kΩ	Film resistor, 1%	0603	Yageo	RC0603FR-0731K6L
1	R44	820kΩ	Film resistor, 1%	0603	Yageo	RC0603FR-07820KL
1	R61	1kΩ	Film resistor, 1%	0603	Yageo	RC0603FR-071KL
2	R47, R55	200Ω	Film resistor, 1%	0603	Yageo	RC0603FR-07200RL
1	R38	3.3kΩ	Film resistor, 1%	0603	Yageo	RC0603FR-073K3L
2	R52, R67	0Ω	Film resistor, 5%	1206	Yageo	RC1206JR-070RL
3	R59, R72, JR1	0Ω	Film resistor, 5%	0603	Yageo	RC0603JR-070RL
2	R40, R70	0Ω	Film resistor, 5%	0805	Yageo	RC0805JR-070RL
1	R54	91kΩ	Film resistor, 1%	0603	Yageo	RC0603FR-0791KL
1	R56	51Ω	Film resistor, 1%	1206	Yageo	RC1206FR-0751RL
1	R69	100Ω	Film resistor, 1%	1206	Yageo	RC1206FR-07100RL
1	R62	24kΩ	Film resistor, 1%	0603	Yageo	RC0603FR-0724KL
1	RT1	2Ω	Thermal resistor	DIP	Semitec	2D2-10
2	VAR1, VAR2	471KD 14	MOV	DIP	TKS	TVR14471KS42Y
1	BR1	GBU8J	Bridge rectifier, 600V, 8A	DIP	Diodes	GBU8J
3	D1, D8, D11	RS1J	Diode, 600V, 1A	SMA	Diodes	RS1J
1	D2	QH08T Z60	Diode, 600V, 8A	TO-220	PI	QH08TZ60

EVHR1203-Y-00A BILL OF MATERIALS (continued)

Qty	Ref	Value	Description	Package	Manufacturer	Manufacturer P/N
2	D4, D5	WSGC10MH	Diode, 1000V, 1A	1206	ZOWIE	WSGC10MH
2	D6, D7	1N4148WS	Diode, 75V, 0.15A	SOD-323	Diodes	1N4148WS
3	D10, D13, D21	1N4148W	Diode, 75V, 0.15A	SOD-123	Diodes	1N4148W
2	D15, D19	B160	Schottky diode, 60V, 1A	SMA	Diodes	B160
1	F1	5A/300VAC	FUSE-SS-5H	DIP	COOPER BUSSMANN	SS-5H-5A
1	L4	42 μ H	Common choke, 42 μ H, 6.5A	DIP	Würth	744842742
1	L1	300 μ H	Filter inductor, 300 μ H, 3A	DIP	Würth	7447065
1	L5	10mH	Common choke, 10mH, 5A	DIP	Würth	744825510
1	L2	260 μ H	PFC inductor, L = 260 μ H, PQ3230	DIP	Emei	FX0432
1	L6	80 μ H	Resonant inductor, EE20	DIP	Emei	FX0430
2	L7	Jumper wire	Jumper wire instead	DIP		
1	Q1	IPP60R199CP	N-channel MOSFET, 650V, 16A	TO220	Infineon	IPP60R199CP
2	Q3, Q6	IPP65R380E	N-channel MOSFET, 700V, 29A	TO220	Infineon	IPP65R380E6
2	Q2, Q4	IRFB7437	N-channel MOSFET, 40V, T _O -220	TO220	IR	IRFB7437
1	T1	0.65mH	Transformer, L _P = 0.65mH, N1:N2:N3:N4:N5 = 48:5:5:3:3, PQ3230	DIP	Emei	FX0433
1	U3	HR1203	PFC + LLC COMBO controller	SOIC28	MPS	HR1203GY
1	U6	TL431	Shunt regulator, V _{REF} = 2.5V	SOT-23	Changjiang Electronics	TL431
1	U5	PC817C	Photocoupler, single- channel	DIP	SHARP	PC817C
1	U2	MP6922	SR controller	SOIC8	MPS	MP6922DS-LF-Z
1	LED1	HL-PSC- 2012H203BC	LED, blue	0805	BRIGHT LED	HL-PSC- 2012H203BC
5	VOUT, GND, L, N, Earth		2mm connector pin			
1	HS1					
1	HS2					
1	HS3					
1	HS4					
1	CN2		Connector 2*5			
1	PCB		EVHR1203-Y-00A			

EVB TEST RESULTS

Performance waveforms are tested on the evaluation board.

$V_{IN_AC} = 90V$ to $265V$, $V_{OUT} = 12V$, $I_{OUT} = 20A$, $P_{OUT} = 240W$

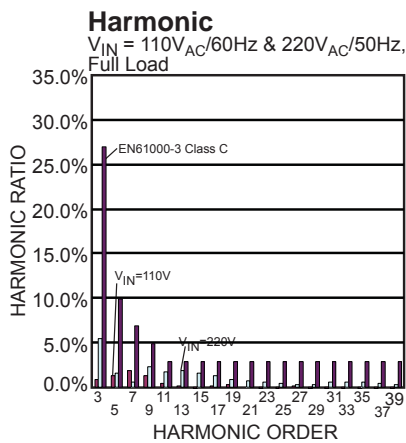
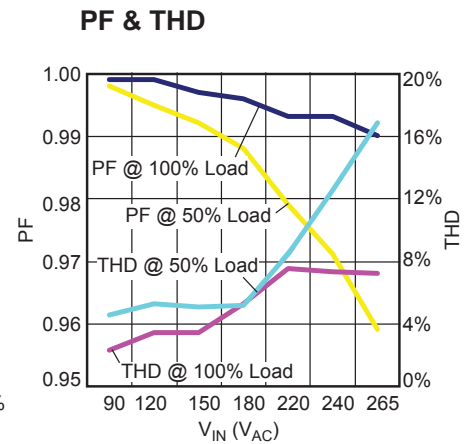
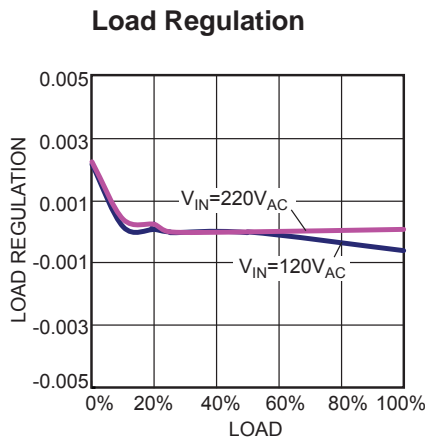
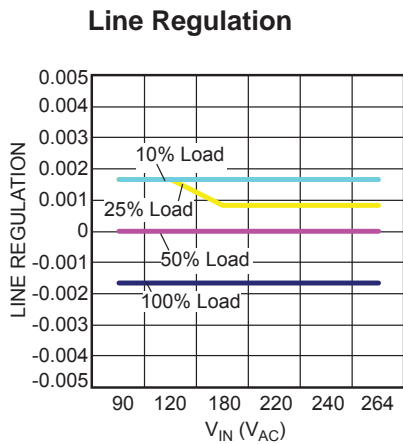
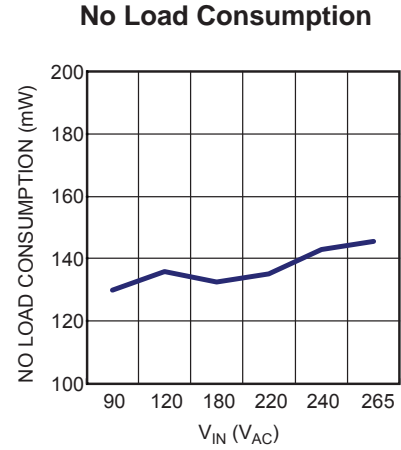
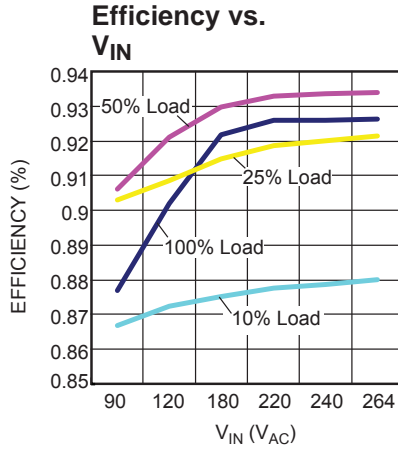
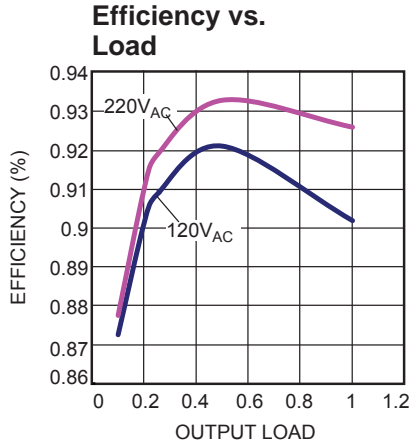

EVB TEST RESULTS (continued)

Performance waveforms are tested on the evaluation board.

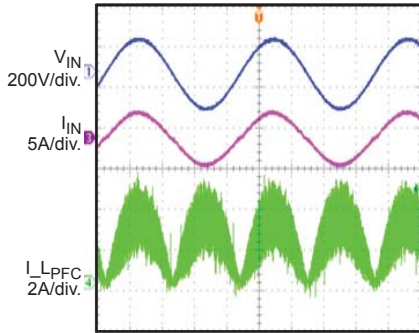
 $V_{IN_AC} = 90V$ to $265V$, $V_{OUT} = 12V$, $I_{OUT} = 20A$, $P_{OUT} = 240W$
Input Voltage & Current
 $V_{IN} = 115V_{AC}$, Full Load

4ms/div.

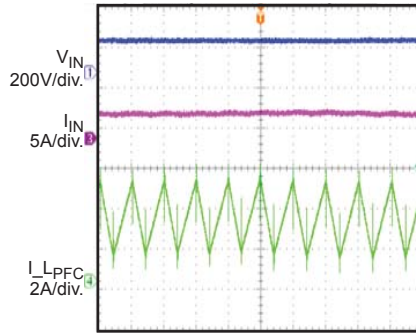
PFC Stage
 $V_{IN} = 115V_{AC}$, Full Load

10µs/div.

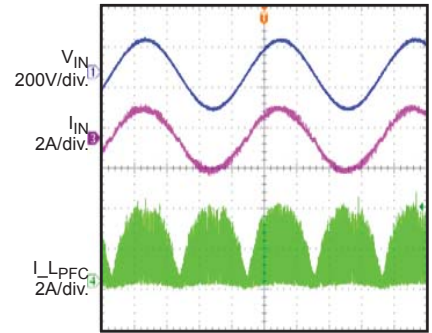
Input Voltage & Current
 $V_{IN} = 115V_{AC}$, 50% Load

4ms/div.

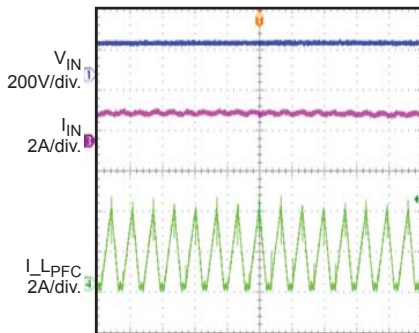
PFC Stage
 $V_{IN} = 115V_{AC}$, 50% Load

20µs/div.

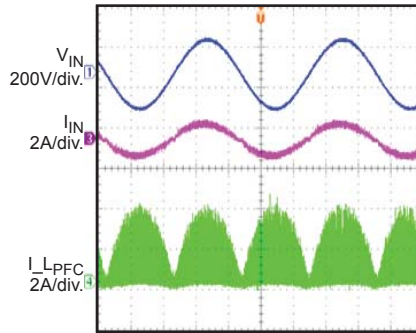
Input Voltage & Current
 $V_{IN} = 115V_{AC}$, 25% Load

4ms/div.

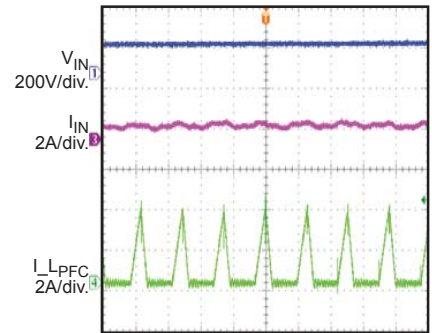
PFC Stage
 $V_{IN} = 115V_{AC}$, 25% Load

20µs/div.

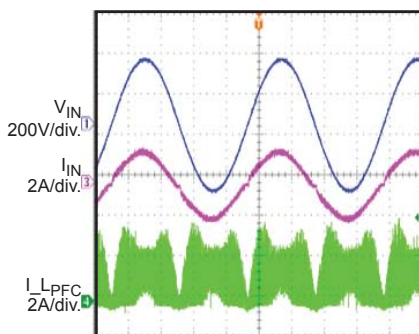
Input Voltage & Current
 $V_{IN} = 230V_{AC}$, Full Load

4ms/div.

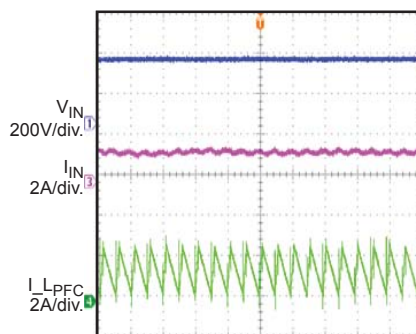
PFC Stage
 $V_{IN} = 230V_{AC}$, Full Load

20µs/div.

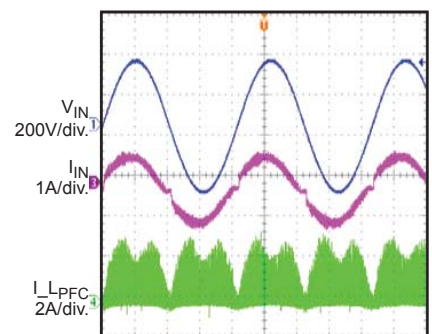
Input Voltage & Current
 $V_{IN} = 230V_{AC}$, 50% Load

4ms/div.

EVB TEST RESULTS (continued)

Performance waveforms are tested on the evaluation board.

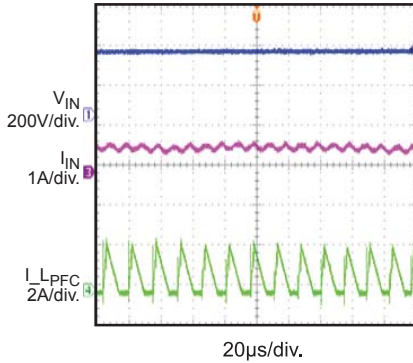
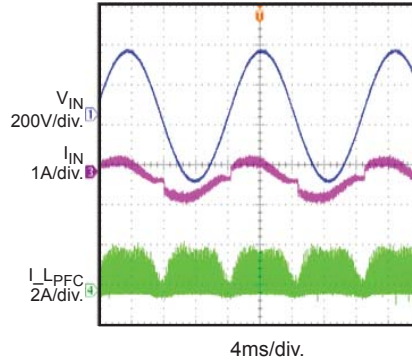
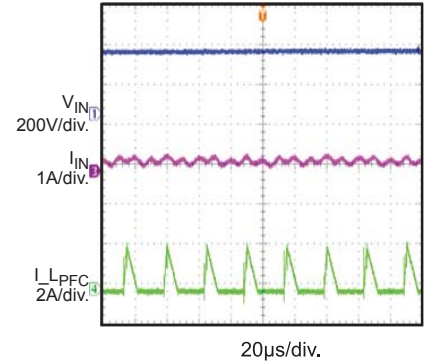
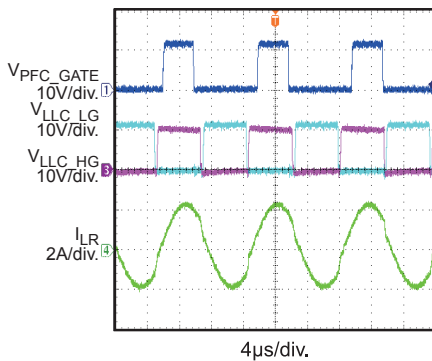
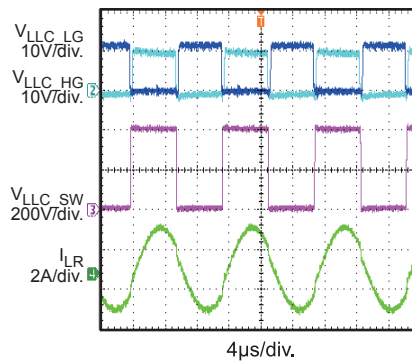
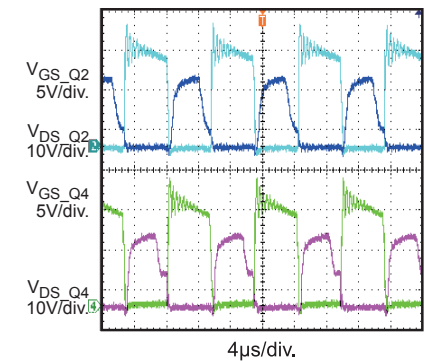
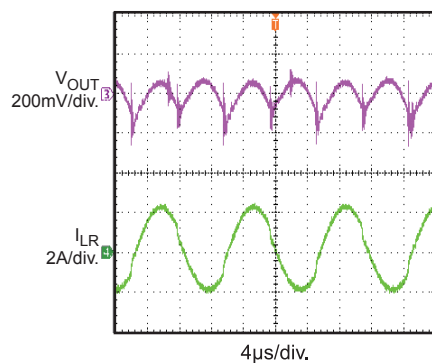
 $V_{IN_AC} = 90V \text{ to } 265V$, $V_{OUT} = 12V$, $I_{OUT} = 20A$, $P_{OUT} = 240W$
PFC Stage
 $V_{IN} = 230V_{AC}$, 50% Load

Input Voltage & Current
 $V_{IN} = 230V_{AC}$, 25% Load

PFC Stage
 $V_{IN} = 230V_{AC}$, 25% Load

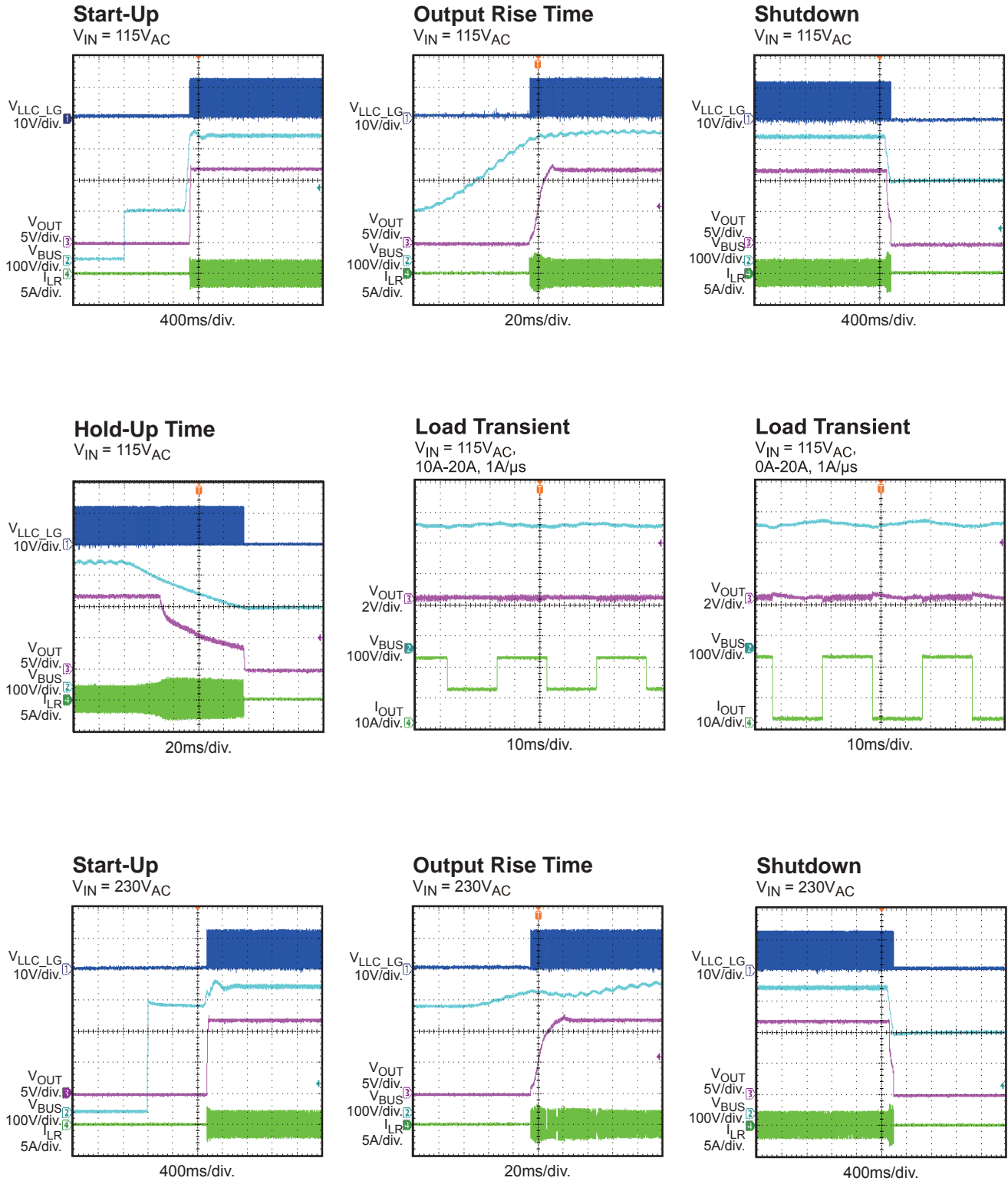
Steady State

LLC Stage

SR Operation

Output Ripple

EVB TEST RESULTS (continued)

Performance waveforms are tested on the evaluation board.

 $V_{IN_AC} = 90V \text{ to } 265V$, $V_{OUT} = 12V$, $I_{OUT} = 20A$, $P_{OUT} = 240W$

EVB TEST RESULTS (continued)

Performance waveforms are tested on the evaluation board.

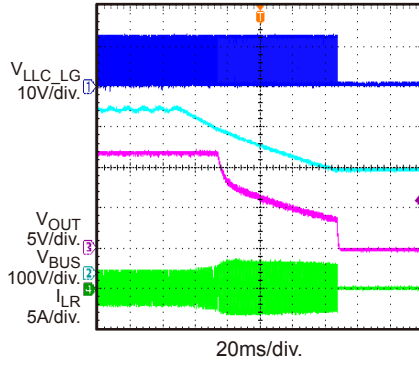
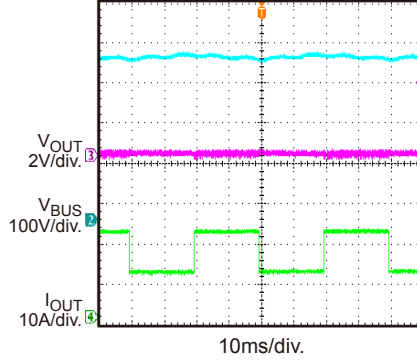
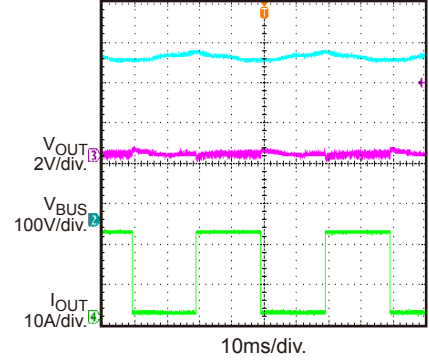
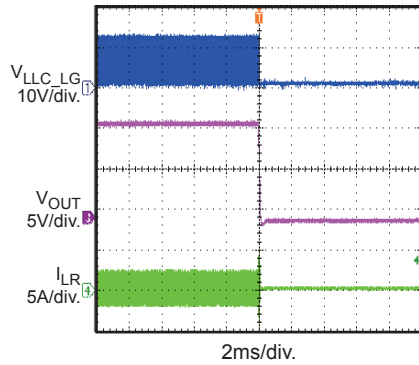
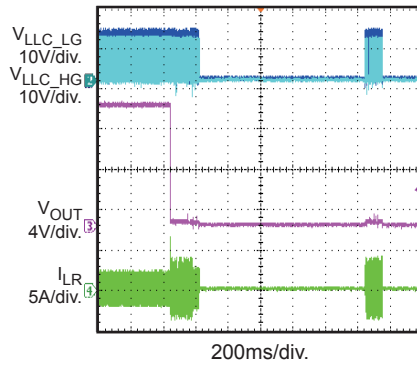
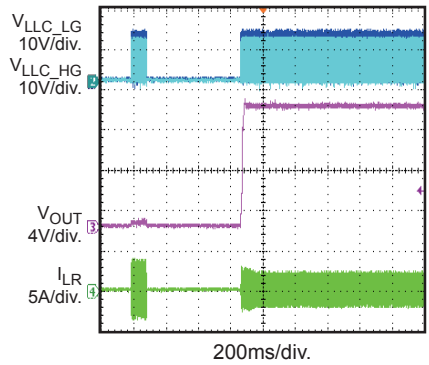
 $V_{IN_AC} = 90V$ to $265V$, $V_{OUT} = 12V$, $I_{OUT} = 20A$, $P_{OUT} = 240W$
Hold-Up Time
 $V_{IN} = 230V_{AC}$

Load Transient
 $V_{IN} = 230V_{AC}$,
 10A-20A, 1A/ μ s

Load Transient
 $V_{IN} = 230V_{AC}$,
 0A-20A, 1A/ μ s

SCP Latch

OCP Enter

OCP Recovery

PCB LAYOUT

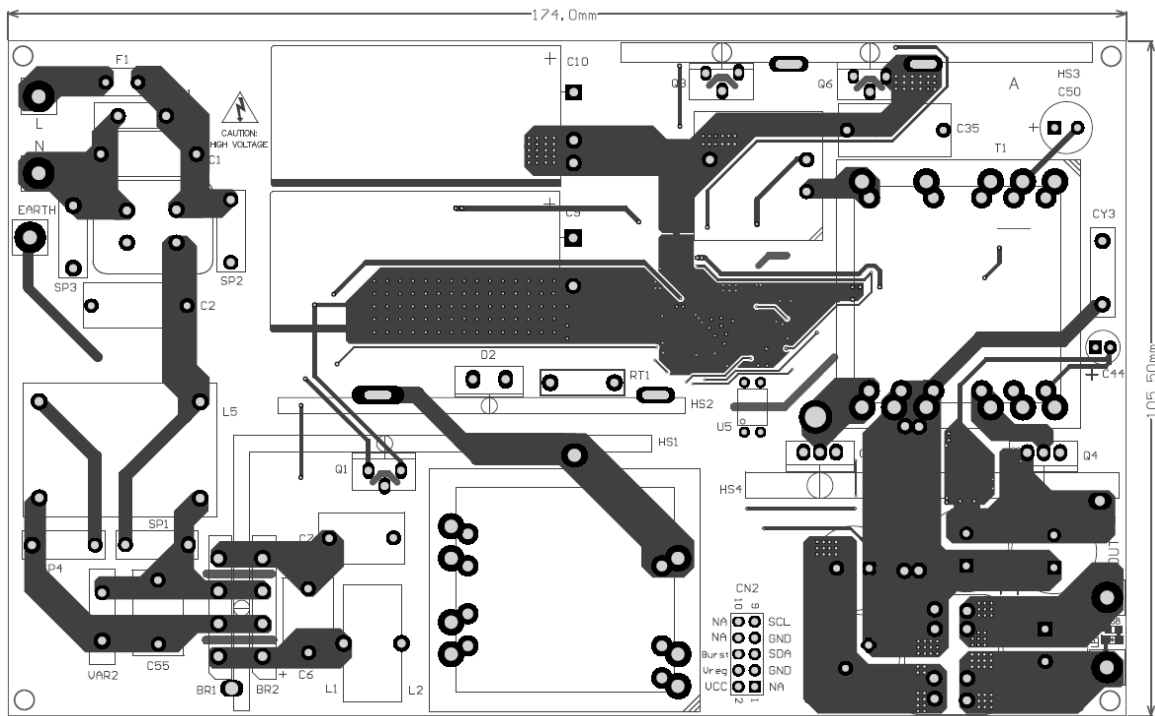

Figure 1: Top Layer

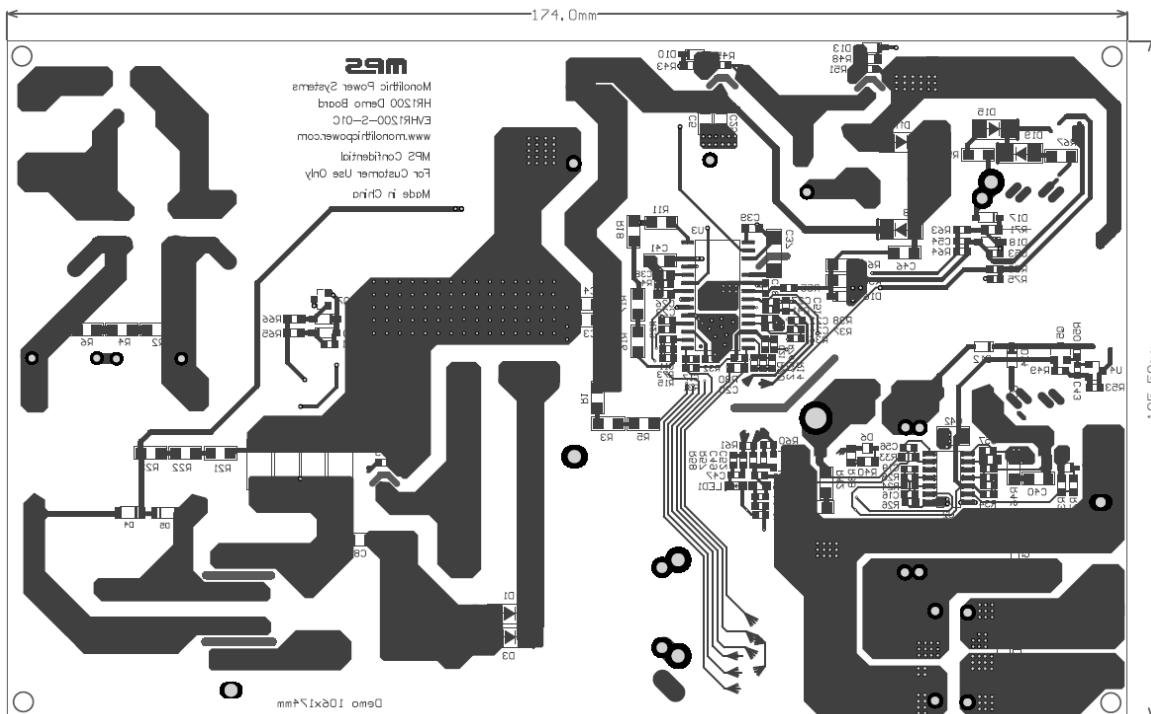

Figure 2: Bottom Layer

SURGE TEST

Line-to-line 4kV and line-to-power earth 4kV surge testing was completed according to EN61000-4-5 Level 4.

The input voltage was set at 220V_{AC}/50Hz. The output was loaded at full load, and operation was verified following each surge event (see Table 1).

Table 1: Surge Test Results

Surge Level (V)	Input Voltage (V _{AC})	Injection Location	Injection Phase (°)	Test Result (Pass/Fail)
4000	220	L to N	90	Pass
-4000	220	L to N	270	Pass
4000	220	L to PE	90	Pass
-4000	220	L to PE	270	Pass
4000	220	N to PE	90	Pass
-4000	220	N to PE	270	Pass

CONDUCTED EMI TEST

Figure 3 shows the test with a 115V_{AC} input and full-load condition.

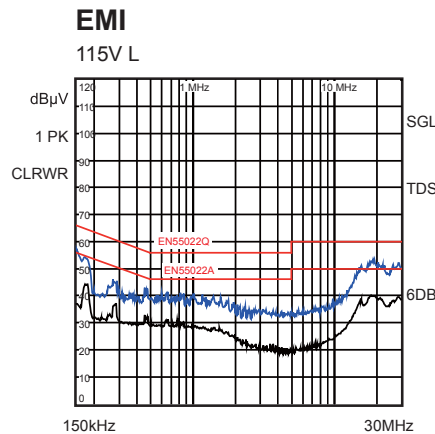

Figure 3: 115V_{AC}, 60Hz, Maximum Load, EN55022 Limits

Figure 4 shows the test with a 230V_{AC} input and full-load condition.

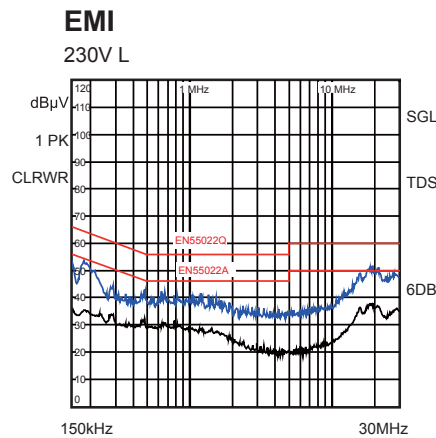

Figure 4: 230V_{AC}, 50Hz, Maximum Load, EN55022 Limits

THERMAL TEST

Figure 5 shows the test with 90V_{AC} input and full-load condition. The PCB layout is with 2oz copper. The ambient temperature is 33°C without air flow.

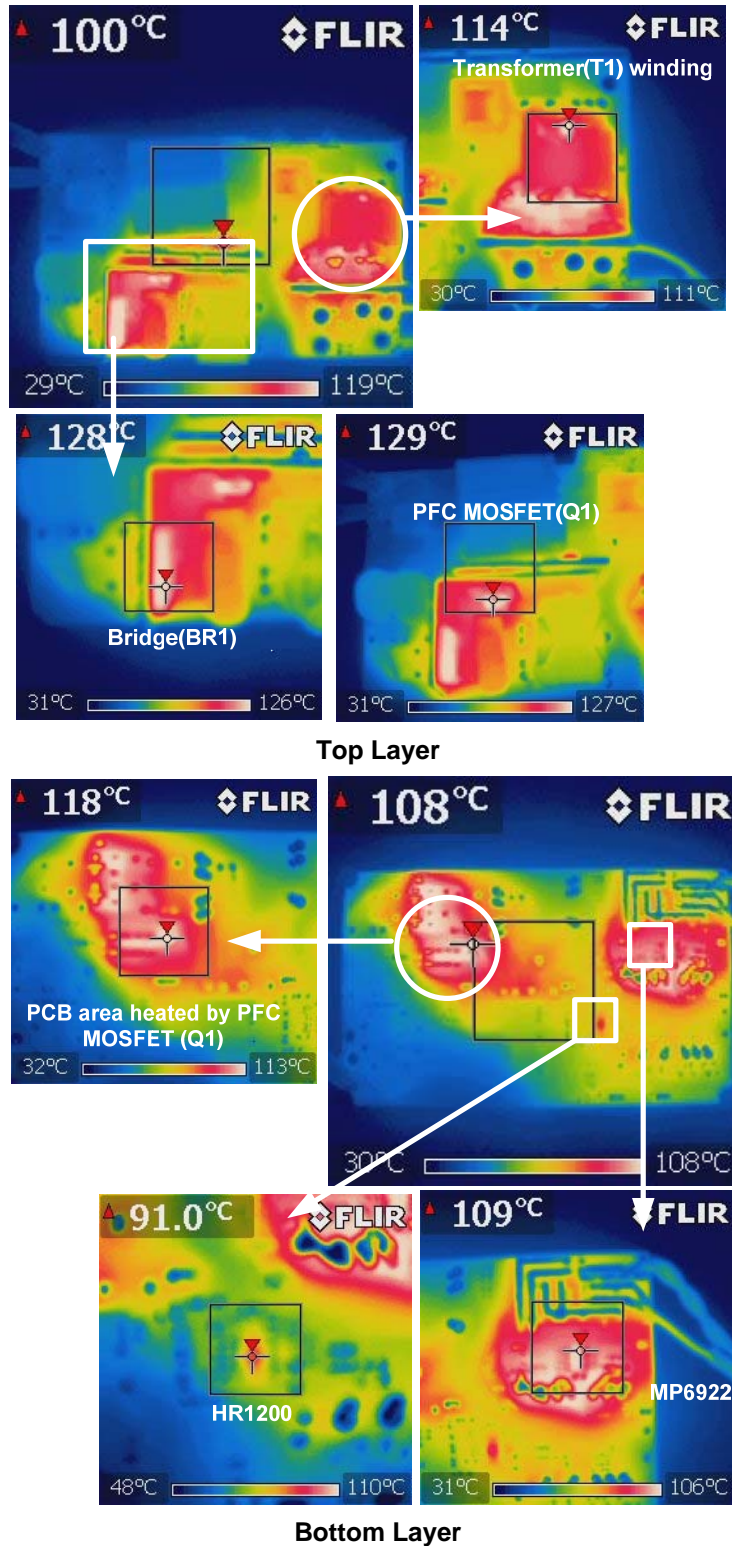

Figure 5: Temperature Chamber Test

QUICK-START GUIDE

To quick start the EVB, follow the steps below.

1. Pre-set the power supply to $90V_{AC} \leq V_{IN} \leq 265V_{AC}$.
2. Turn the power supply off.
3. Connect the line and neutral terminals of the power supply output to the L and N ports. For three-wire input applications, connect the earth terminal to the earth port.
4. Connect the positive (+) load to VOUT.
5. Connect the negative (-) load to GND.
6. Turn the power supply on after making the connections.
7. Discharge the bulk capacitor for safety consideration after power-off.

CONTACT INFORMATION

To request this evaluation board, please refer to your local sales office:

<http://www.monolithicpower.com/Company/Contact-Us>

DISCLAIMER

Monolithic Power Systems (MPS) reserves the right to make changes to its products and to discontinue products without notice. The applications information, schematic diagrams, and other reference information included herein are provided as a design aid only and are therefore provided as-is. MPS makes no warranties with respect to this information and disclaims any implied warranties of merchantability or non-infringement of third-party intellectual property rights.

MPS cannot assume responsibility for use of any circuitry other than circuitry entirely embodied in a MPS product. No circuit patent licenses are implied.

Certain applications using semiconductor products may involve potential risks of death, personal injury, or severe property or environmental damage (“Critical Applications”).

MPS PRODUCTS ARE NOT DESIGNED, INTENDED, AUTHORIZED, OR WARRANTED TO BE SUITABLE FOR USE IN LIFE SUPPORT APPLICATIONS, DEVICES OR SYSTEMS, OR OTHER CRITICAL APPLICATIONS.

Inclusion of MPS products in critical applications is understood to be fully at the risk of the customer. Questions concerning potential risk applications should be directed to MPS.

MPS semiconductors are typically used in power supplies in which high voltages are present during operation. High-voltage safety precautions should be observed in design and operation to minimize the chance of injury.

REVISION HISTORY

Date	Author	Revision	Description & Changes	Reviewed

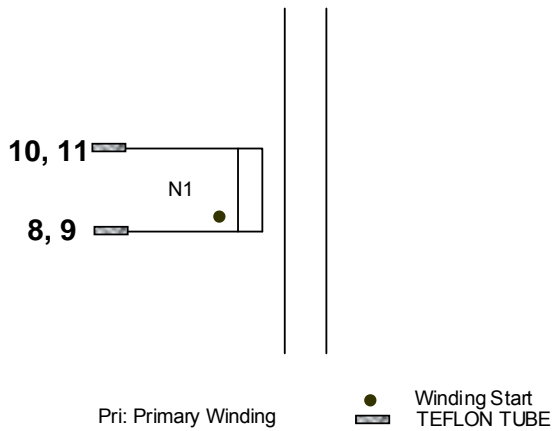
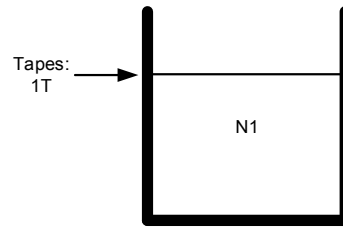
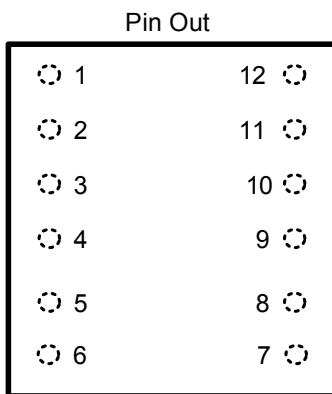
APPENDIX 1: PFC INDUCTOR SPECIFICATION
Electrical Diagram

Winding Diagram

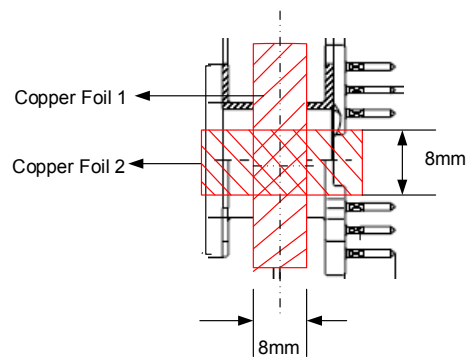
Pin Definition of Bobbin

View from the Top



Note: Core is wrapped with copper foils, as shown above. Connect the foils to pin 4 of the bobbin with wires.

Table 2: Electrical Characteristic

Parameter	Condition	Value
Primary inductance	L (8, 9-10, 11)	260 μ H \pm 10%
Core		PQ3230
Bobbin		PQ3230
Core material		DMR40 or equivalent
Turn ratio	N1	

Table 3: Winding Specification

Tape Turns	Winding No.	Margin Tapes	Start and End	Wire Diameter (mm)	Turns
1	N1		8, 9→10, 11	0.1x100	30

APPENDIX 2: LLC TRANSFORMER SPECIFICATION

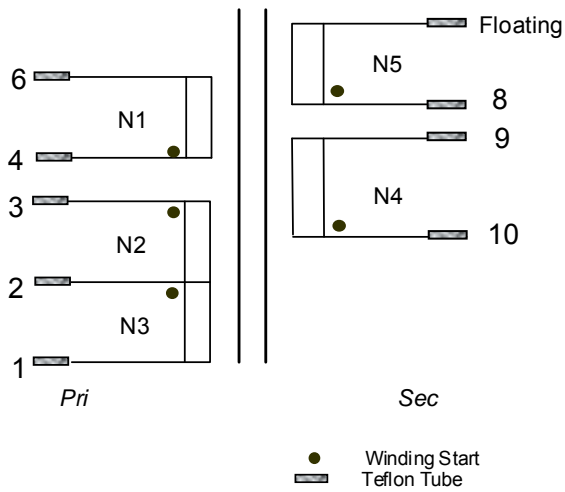
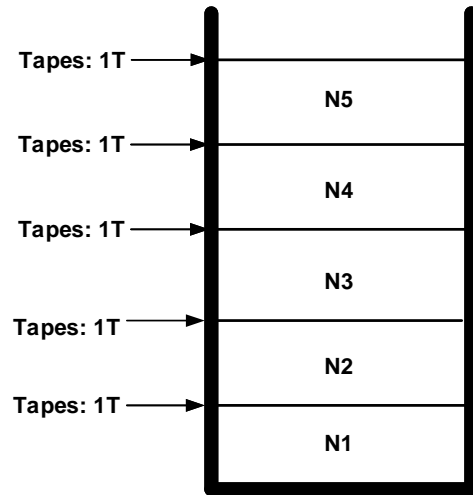
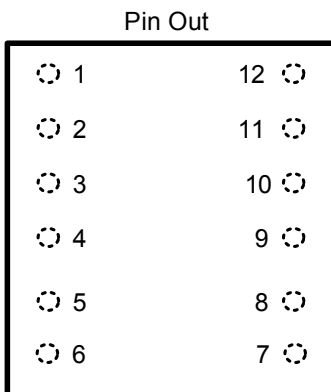
Electrical Diagram

Winding Diagram

Pin Definition of Bobbin

View from the Top

Table 4: Electrical Characteristic

Parameter	Condition	Value
Primary inductance	L_P (4-6)	0.55mH \pm 5%
Core		PQ3230
Bobbin		PQ3230
Core material		DMR44 or equivalent
Turn ratio	N1:N2:N3:N4:N5	48:5:5:3:3

Table 5: Winding Specification

Tape Turns	Winding No.	Margin Tapes	Start and End	Wire Diameter (mm)	Turns
1	N1		4→6	0.1x30	48
1	N2		3→2	0.2x3	5
1	N3		2→1	0.2x3	5
1	N4		8→floating	0.1x100	3
1	N5		10→9	0.1x100	3

APPENDIX 3: LLC RESONANT INDUCTOR SPECIFICATION

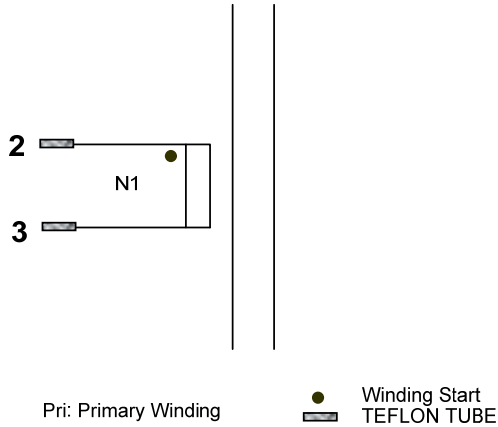
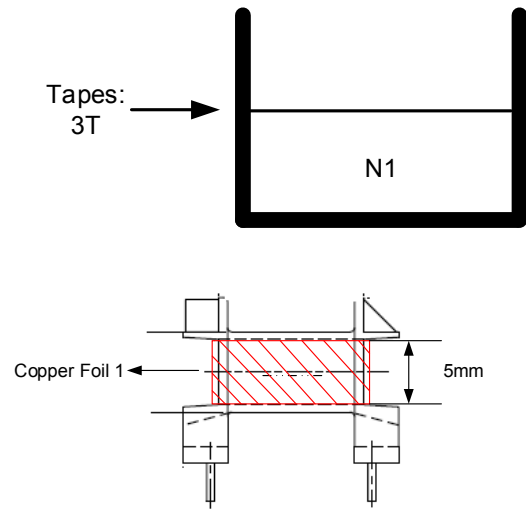
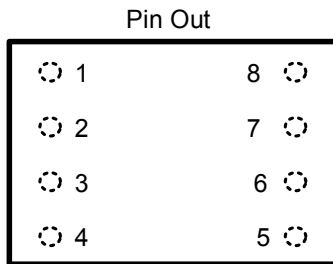
Electrical Diagram

Winding Diagram

Pin Definition of Bobbin

View from the Top

Note: Core is wrapped with copper foil, as shown above. Connect the foils to pin 6 of the bobbin with wires.

Table 6: Electrical Characteristic

Parameter	Condition	Value
Primary inductance	L (2-3)	80 μ H \pm 5%
Core		EE20/10/6
Bobbin		EE20/10/6
Core material		DMR40 or equivalent
Turn ratio	N1	40

Table 7: Winding Specification

Tape Turns	Winding No.	Margin Tapes	Start and End	Wire Diameter (mm)	Turns
3	N1		2→3	0.1x30	40

NOTICE: The information in this document is subject to change without notice. Please contact MPS for current specifications. Users should warrant and guarantee that third-party Intellectual Property rights are not infringed upon when integrating MPS products into any application. MPS will not assume any legal responsibility for any said applications.