



User Guide

MP2695 Evaluation Kit (EVKT-MP2695)

Table of Contents

Overview	2
Introduction	2
Kit Contents	2
Features and Benefits	3
Kit Specifications	4
Section 1. Hardware Specifications	5
1.1 Personal Computer Requirements	5
1.2 EV2695-Q-01A Specifications	5
1.3 EVKT-USBI2C-02 Specifications	5
Section 2. Software Requirements	6
2.1 Software Installation Procedure	6
Section 3. Evaluation Kit Test Set-Up	7
3.1 Hardware Set-Up	7
3.2 Powering Up the EVB	7
3.3 Software Set-Up	7
3.4 Device Programming Instructions	8
3.5 Troubleshooting Tips	10
Section 4. Ordering Information	12

Overview

Introduction

The EVKT-MP2695 is an evaluation kit for the MP2695. This board is designed for the MP2695, which is a highly integrated, single-cell Li-ion/Li-polymer battery charger. Its layout accommodates most commonly used capacitors. The default function of this board is preset for charger mode, and the charge full voltage is preset to 4.200V for a single-cell Li-ion battery.

Kit Contents

EVKT-MP2695 kit contents (items below can be ordered separately):

#	Part Number	Item	Quantity
1	EV2695-Q-01A	MP2695 evaluation board	1
2	EVKT-USBI2C-02-Bag	Include one USB to I ² C communication interface, one USB cable, and one ribbon cable	1
3	Online Resources	Include datasheet, user guide, product brief, and GUI	1

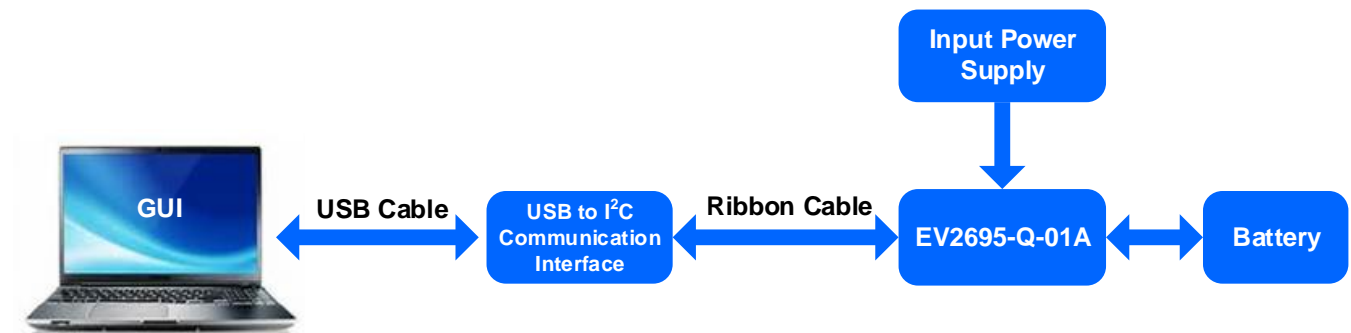

Figure 1: EVKT-2695 Evaluation Kit Set-Up

Features and Benefits

The MP2695 is a highly integrated, flexible, switch-mode battery charger. It offers:

- Power switches
 - IN to PMID block FET (25mΩ)
 - HSFET (15mΩ)
 - LSFET (15mΩ)
- No external blocking diode
- 4.0V to 11V operation voltage range, with up to 16V sustainable input voltage
- Minimum input voltage loop for maximum adapter power tracking
- Accuracy
 - ±0.5% charge regulation voltage from 3.6V to 4.45V
 - ±5% charge current from 500mA to 3600mA
 - ±10% input current limit from 100mA to 3000mA
- Ultra-low 25µA battery discharge current in idle mode
- Comprehensive safety features
 - Fully customizable JEITA profile with programmable temperature threshold
 - Charge safety timer
 - Input over-voltage protection
 - Battery under-voltage protection
 - Thermal limiting regulation and thermal shutdown
- Analog voltage output IB pin for battery current monitor
- I²C interface for setting parameters and status reporting
- Small 3mmx3mm QFN-21 package

⚠ All changes made in I²C mode will NOT be retained once the EVB is powered down.

⚠ Information written in OTP mode CANNOT be changed.

Adjustable features:

I ² C	OTP
<ul style="list-style-type: none"> • Battery Regulation Voltage • Charge Current • Pre-Charge Current • Charge Termination Current • Input Voltage Regulation • Input Current Limit • VIN_OVP • JEITA_VSET • JEITA_ISET • Hot Threshold • Warm Threshold • Cool Threshold • Cold Threshold • NTC Action • SW_FREQ 	<ul style="list-style-type: none"> • Battery Regulation Voltage • Input OVP Threshold • NTC Action

Kit Specifications

Feature	Specification
Supply for Board	4.5V to 11.0V
Operating Input Voltage	4.5V to 11.0V
Operating Systems Supported	Windows XP, 7, and later
System Requirements	Minimum 22.2MB free
GUI Software	MP2695 V1.0

Section 1. Hardware Specifications

1.1 Personal Computer Requirements

The following must be met to use the EVKT-MP2695:

- Operating System of Windows XP, 7, or later
- Net Framework 4.0
- PC with a minimum of one available USB port
- At least 22.2MB of free space

1.2 EV2695-Q-01A Specifications

The EV2695-Q-01A is an evaluation board for the MP2695. For more information, refer to the EV2695-Q-01A datasheet.



Figure 2: EV2695-Q-01A Evaluation Board

Feature	Specification
Supply for Evaluation Board	4.5V to 11.0V
Operating Input Voltage	4.5V to 11.0V
EVB Size (LxW)	6.3cmx6.3cm

1.3 EVKT-USBI2C-02 Specifications

The EVKT-USBI2C-02 refers to the communication interface, which connects the EVB, the PC, and its supporting accessories. Together with eMotion System™ Virtual Bench Pro and I²C GUI tools, it provides a quick and easy way to evaluate the performance of MPS digital products. For more details, refer to the EVKT-USBI2C-02 datasheet.



Figure 3: EVKT-USBI2C-02 Communication Interface

Section 2. Software Requirements

2.1 Software Installation Procedure

Programming occurs through the MPS I²C GUI. Follow the instructions below to download and install the software.

Note: This software can be downloaded directly from the MPS website at:

<http://hz-coc-ebench/Installation/File.aspx?categoryID=7>

1. Visit the link above and download the “I²C evaluation kit software for MP2695” to a directory of your choice.
2. Extract the zip package and double-click the .exe file to open the set-up guide (see Figure 4). If a protection window comes up, click “More info,” then click “Run anyway.”
3. Follow the prompts in the set-up guide.
4. Wait for status screen to verify that installation is complete (see Figure 5).

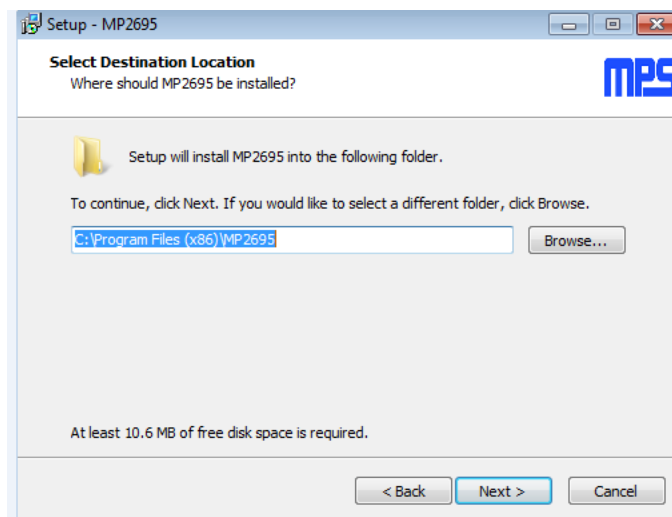

Figure 4: MPS I²C GUI Set-Up Guide

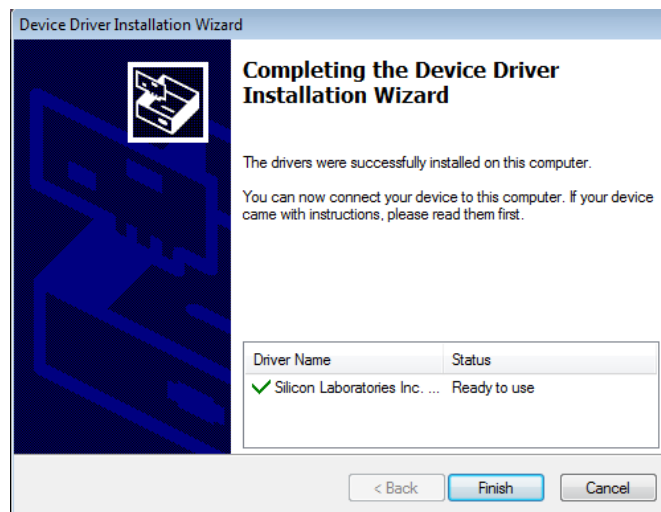

Figure 5: Driver Set-Up Success

Section 3. Evaluation Kit Test Set-up

3.1 Hardware Set-Up

The hardware must be properly configured prior to use. Follow the instructions below to set up the EVB:

1. Locate the proper wires to connect the EVB to the EVKT-USBI2C-02 communication interface.
2. Connect SCL, SDA, and GND (see Figure 6). If needed, refer to the datasheet for further clarification.

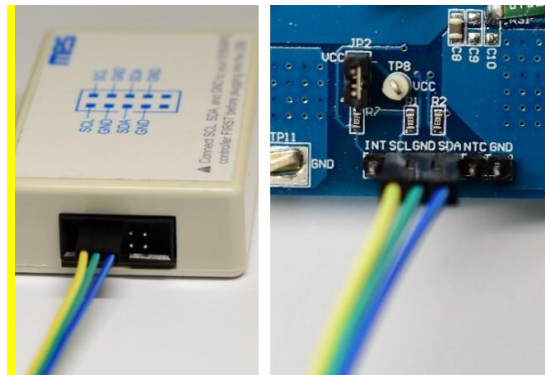

Figure 6: EVB to MPS USB Communication Interface Wire Connection

3.2 Powering up the EVB

1. Connect the positive and negative terminals of the battery to the BATT(TP1) and GND(TP4) pins, respectively. (If it is a battery simulator, preset the battery voltage between 0V and 4.45V, then turn it off. Connect the battery simulator output to the BATT and GND pins, respectively.)
2. Preset the power supply output between 4.5V and 6.0V, then turn off the power supply. Connect the positive and negative terminals of the power supply output to the VIN(TP3) and GND(TP2) pins, respectively.
3. Make sure the battery voltage is present (if a battery simulator is used, turn on the battery emulator). Turn the power supply on. The IC will automatically enter the power on sequence.

Reminder: If the battery simulator is connected, make sure to turn on the battery emulator before the input supply in the start-up sequence.

3.3 Software Set-Up

After connecting the hardware according to the above steps, follow the steps below to use the GUI software:

1. Start the software. It will automatically check the EVB connection.
 - If connection is successful, both the USB and MP2695 demo board statuses will appear as “Connected” in green (see Figure 7).

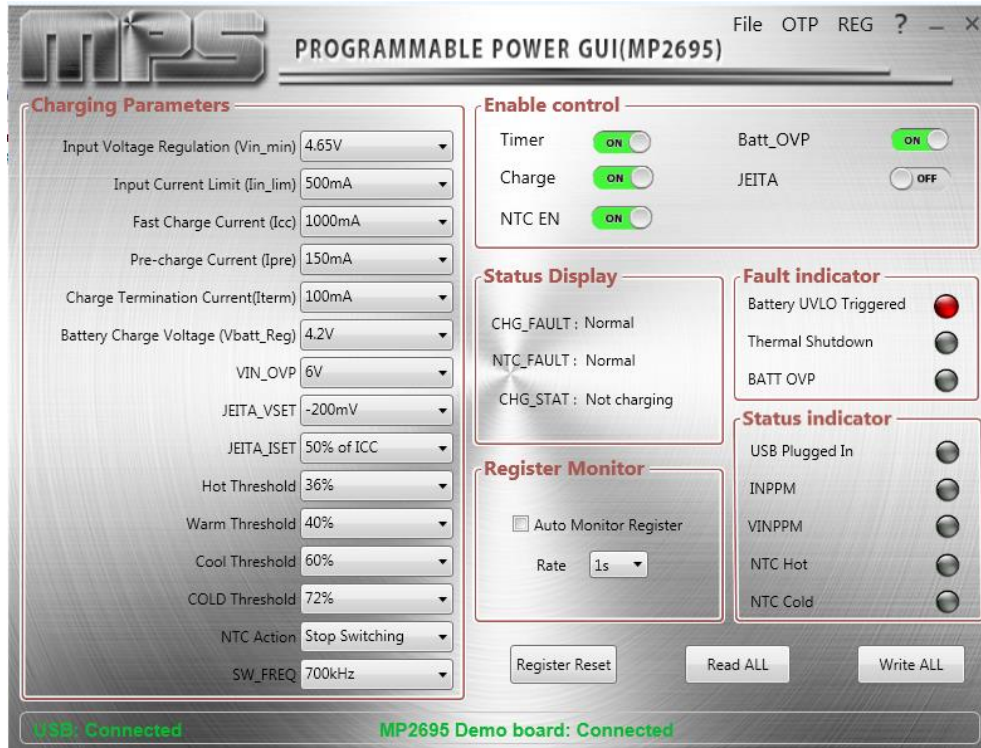

Figure 7: USB Communication Interface and MP2695 EVB Board Connected

2. If not, they will appear as “Disconnected” in red. Check the connections between the EVB, USB communication interface, and PC. Re-plug the USB into the computer and restart the GUI.
 - 1) “MP2695 Demo board: Disconnected” means that the evaluation board is not connected correctly.
 - 2) “USB: Disconnected” means that the USB I²C communication interface is not connected correctly.
3. Click the “Read All” button to read the I²C register values and the default values are displayed (see Figure 7).
4. Find the item you want to change, and select the desired value from the drop-down menu.
5. To update values, click the “Write All” button. The changed information will be downloaded to the IC.

⚠ All changes made via I²C will be restored to default values once the EVB is powered down.

3.4 Device Programming Instructions

The MP2695-xxxx is an OTP part. Follow the instructions below to create and export customized configurations:

1. Open the MPS GUI software.
2. Select “OTP View” in the toolbar (see Figure 8).

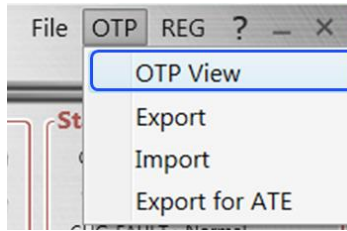

Figure 8: Select OTP

3. Enter a new table (see Figure 9). Any parameters highlighted in red can be changed.

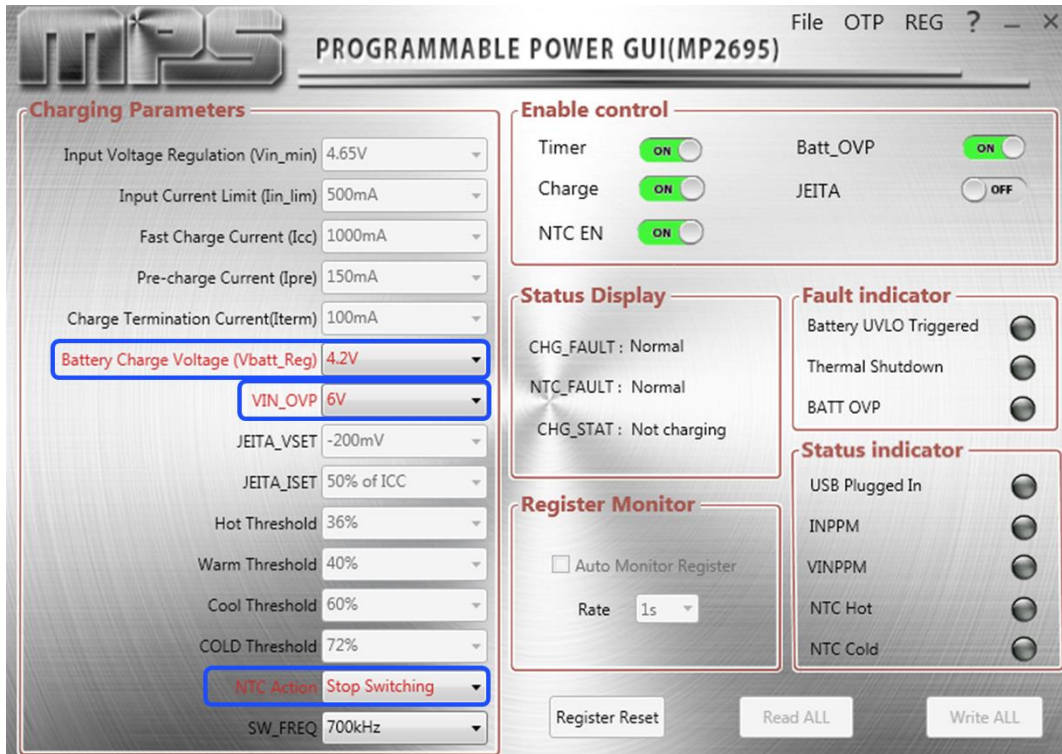
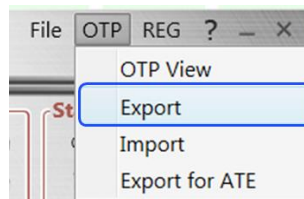

Figure 9: Adjustable Parameters in OTP Mode

4. Select values from the drop-down menus.
5. Ensure that all parameters are populated before selecting “Export.” Export the configuration by clicking “Export” in the toolbar (see Figure 10).



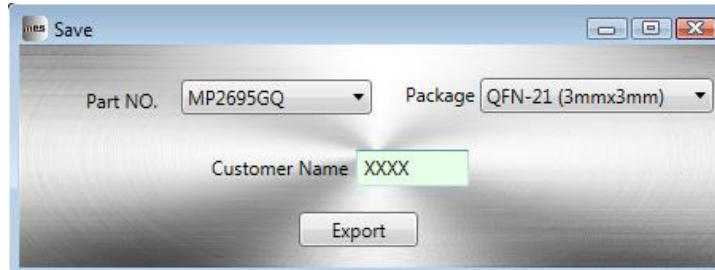

Figure 10: Export Window

6. Find a location for the exported file and click “Save.” Configurations will be saved in a .txt file (see Figure 11).

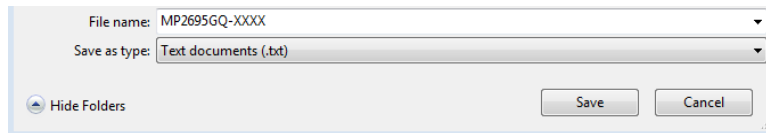

Figure 11: Exporting to a Selected Location

7. Send this file to the FAE, and apply for a customized “xxxx” code.

3.5 Troubleshooting Tips

EVKT-USBI2C-02 Driver Problem

If the USBI2C-02 driver is not properly installed, manual installation is required. Follow the steps below:

1. Install the correct “.exe” file, according to the Windows operation system.
 - 32-bit: \EVKT-USBI2C-02 USB Driver\USBXpressInstaller_x86.exe
 - 64-bit:\EVKT-USBI2C-02 USB Driver\USBXpressInstaller_x64.exe
2. Connect the communication interface to the PC with a USB cable.
3. Find “USBXpress Device” in the Device Manager.

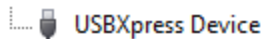

4. If the PC is running Windows 10, check the driver version of the USBXpress Device. Windows 10 may automatically install the older USB driver, which is not compatible. The correct driver version is 4.0.0.0 (see Figure 12).

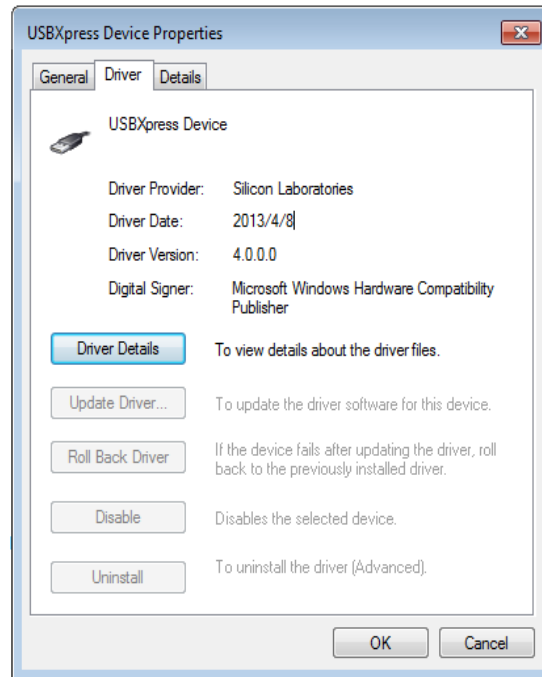

Figure 12: Correct Driver Version 4.0.0.0

No Supply

The IC's input pin has an under-voltage lockout (UVLO) detection circuit. If the input voltage (V_{IN}) is lower than the UVLO rising threshold, the charging function is disabled.

No Charging Event

If the IC detects that V_{IN} is lower than the UVLO falling threshold (enters no supply state) or the over-temperature protection is triggered (enters shutdown state), the IC switches to supplement mode, powered by the battery.

Thermal Recovery

The MP2695 enters a shutdown state if the die temperature exceeds the thermal protection threshold. The IC powers back on when the die temperature decreases.

Section 4. Ordering Information

The components of the evaluation kit may be purchased separately, depending on user needs.

Part Number	Description
EVKT-MP2695	Complete evaluation kit
Contents of EVKT-2695	
EV2695-Q-01A	MP2695-xxxx evaluation board
EVKT-USBI2C-02	Includes one USB to I ² C communication interface, one USB cable, and one ribbon cable
Online Resources	Include datasheet, user guide, product brief, and GUI

Order directly from MonolithicPower.com or our distributors.