



The Future of Analog IC Technology®

# EVM3550E-GLE-00A

36V, 5A, High Efficiency, Fast Transient  
Non-isolated DC-DC Power Module  
With Integrated Inductor

## DESCRIPTION

EVM3550E-GLE-00A Demo Board is based on MPM3550E Module. The MPM3550E is a high density, non-isolated DC-DC power module for space sensitive applications. The module offers a very compact solution to achieve 5A continuous output current with fast transient and good stability over wide input supply and load range, and can provide an adjustable output voltage from 1.0V to 12.0V via an external FB resistor (Default 3.3V output). Ultra-high efficiency is achieved through the use of synchronous rectification and control techniques

The MPM3550E integrates switching controller, power switches, inductors, a modest amount of input and output capacitance and all support components with an advanced 12x12x4.2mm size. And it requires a minimal number of standard external components. This compact solution significantly helps in system design and productivity by offering greatly simplified board design, layout and manufacturing requirements.

The module offers standard features, including of internal fixed soft-start, remote enable control and power good indicator. It has fully integrated protections that include over-current protection, short-circuit protection, output under-voltage protection, input under-voltage lockout and thermal shutdown.

## FEATURES

- Integrated Inductor, Switches, Controller
- High Efficiency Synchronous Mode Control
- Low Component Count and Small Size
- Ease of Design and Fastest Time to Market
- Wide 4.5V to 36V Operating Input Range
- Output Adjustable from 1.0V to 12.0V
- Guaranteed 5A Continuous Output Current
- Ultra-fast Transient Response
- Internal Fixed Soft-Start Time
- External Frequency Selection Pin
- Power Good Indicator
- Non-latch OCP, SCP, UVP and UVLO
- Thermal Shutdown Protection
- Remote Enable Control
- Dimension: 12mmx12mmx4.2mm
- Weight: 1.4g
- Operating Temperature: -40°C to +125 °C
- CISPR25 Class 5 Compliant

## APPLICATIONS

- Automotive Systems
- Industrial Supplies
- Telecom and Networking Systems
- Distributed Power and POL Systems

All MPS parts are lead-free, halogen free, and adhere to the RoHS directive. For MPS green status, please visit MPS website under Quality Assurance. "MPS" and "The Future of Analog IC Technology" are Registered Trademarks of Monolithic Power Systems, Inc.

## EVM3550E-GLE-00A DEMO BOARD

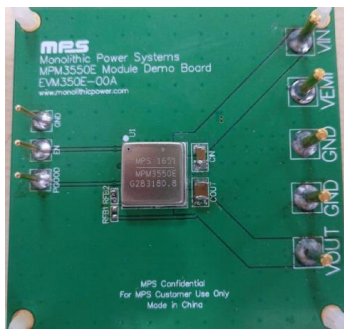

(L x W x H) 6.4cm x 6.4cm x 1.3cm

Board Number	MPS IC Number
EVM3550E-GLE-00A	MPM3550EGLE

### Output Current VS Efficiency

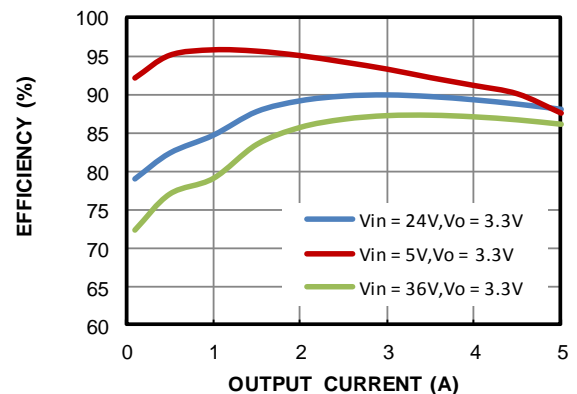

### EVM3550E-GLE-00A SCHEMATIC

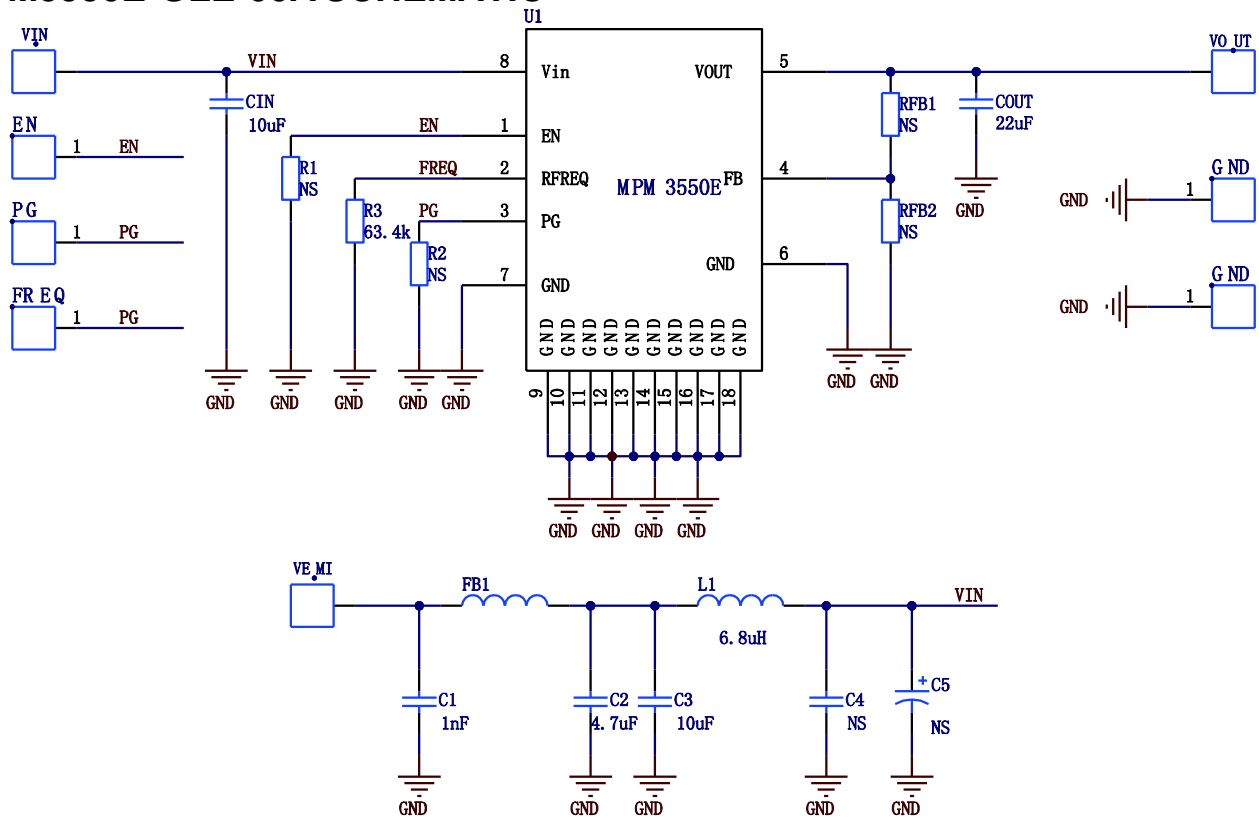

VIN=4.5V-36V, VOUT=3.3V,I=5A

### EVM3550E-GLE-00A BOM

Qty	RefDes	Value	Description	Package	Manufacturer	Manufacturer_P/N
1	CIN	10μF	Ceramic Cap;50V;X7R	1210	MuRata	GRM32ER71H106KA12L
1	COUT	22μF	Ceramic Cap;16V,X7R	1210	MuRata	GRM32ER71C226KEA8L
1	C1	1nF	Ceramic Cap;50V;X7R	0603	WE	885012206083
1	C2	4.7μF	Ceramic Cap;50V;X7R	1210	MuRata	GRM32ER71H475KA88L
1	C3	10μF	Ceramic Cap;50V;X7R	1210	MuRata	GRM32ER71H106KA12L
1	FB1	100MHz	RDC=9.5mΩ,Ir=5.4A	1206	WE	7427922111
1	R3	63.4k	1% Film resistor, 63.4k	0603	YAGEO	RC0603FR-0763K4L
1	L1	6.8μH	Inductor, RDC=11.4 mohm , Isat=13A	7040	WE	74437346068
1	U1	MPM3550E	DC-DC Module	LGA12X12	MPS	MPM3550EGLE
1	RFB1	NS	\	\	\	\
1	RFB2	NS	\	\	\	\
2	R1, R2	NS	\	\	\	\
2	C4,C5	NS	\	\	\	\

## TYPICAL PERFORMANCE CHARACTERISTICS

$V_{IN} = 24V$ ,  $V_{OUT} = 3.3V$ , External  $C_{OUT}=22\mu F$ ,  $T_A = 25^\circ C$ , unless otherwise noted.

Output Current VS Efficiency

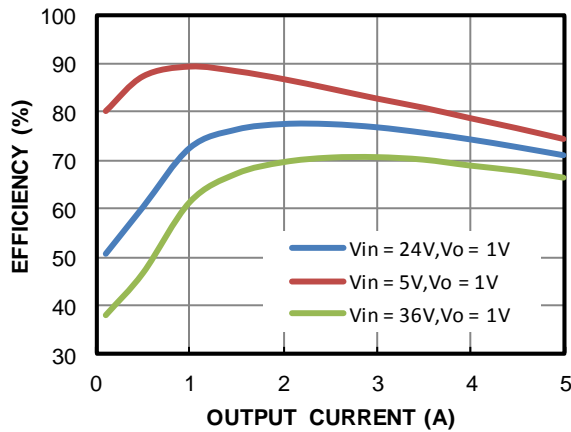

Output Current VS Efficiency

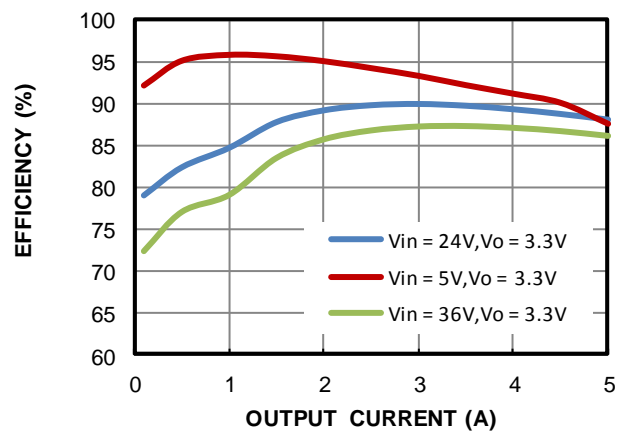

Output Current VS Efficiency

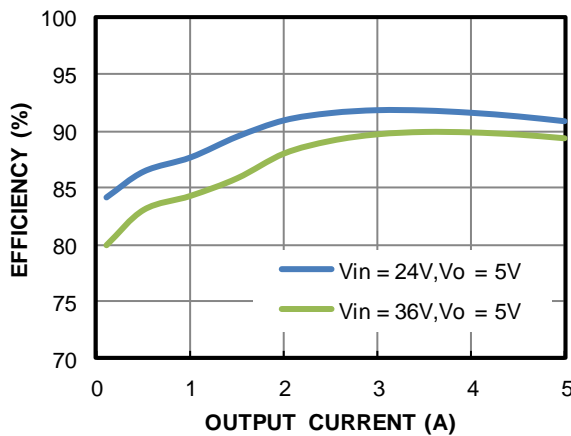

Output Current VS Load Regulation

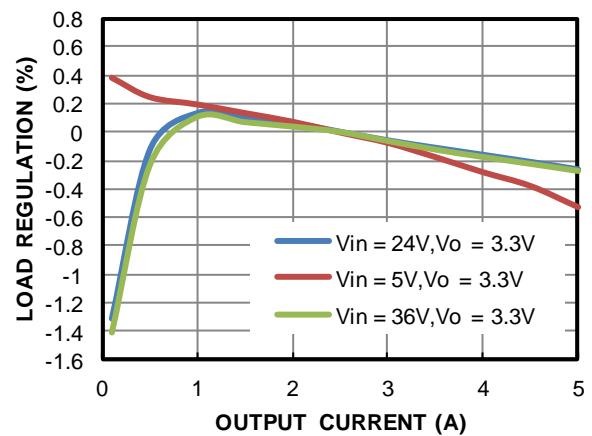

Input Voltage VS Line Regulation

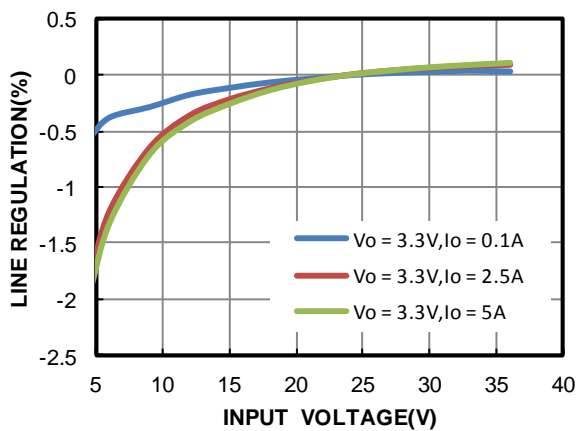

**TYPICAL PERFORMANCE CHARACTERISTICS (continued)**

$V_{IN} = 24V$ ,  $V_{OUT} = 3.3V$ , External  $C_{OUT}=22\mu F$ ,  $T_A = 25^\circ C$ , unless otherwise noted.

**Vin startup**

$V_{IN} = 24V$   $V_{OUT} = 3.3V$   $I_{OUT} = 0A$

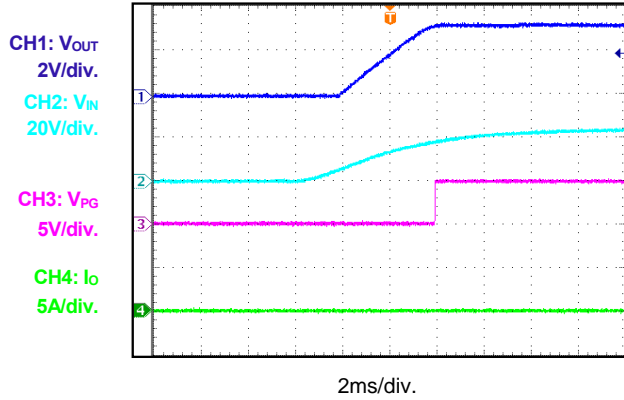

**Vin startup**

$V_{IN} = 24V$   $V_{OUT} = 3.3V$   $I_{OUT} = 5A$

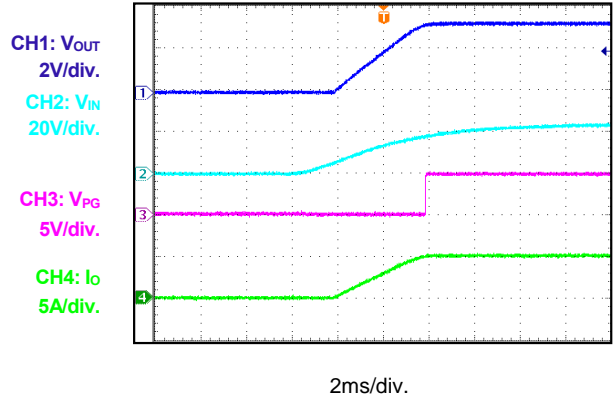

**Vin Shutdown**

$V_{IN} = 24V$   $V_{OUT} = 3.3V$   $I_{OUT} = 0A$

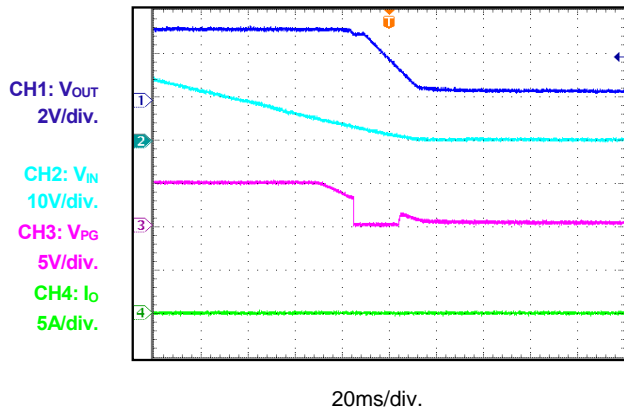

**Vin Shutdown**

$V_{IN} = 24V$   $V_{OUT} = 3.3V$   $I_{OUT} = 5A$

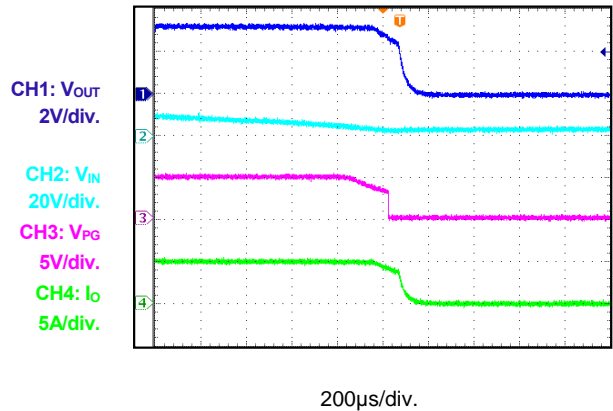

**EN Startup**

$V_{IN} = 24V$   $V_{OUT} = 3.3V$   $I_{OUT} = 0A$

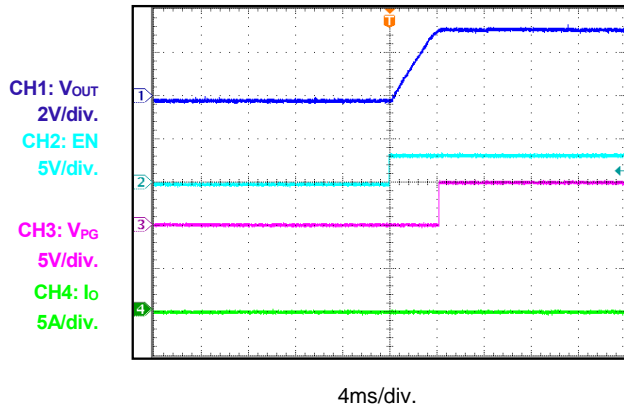

**EN Startup**

$V_{IN} = 24V$   $V_{OUT} = 3.3V$   $I_{OUT} = 5A$

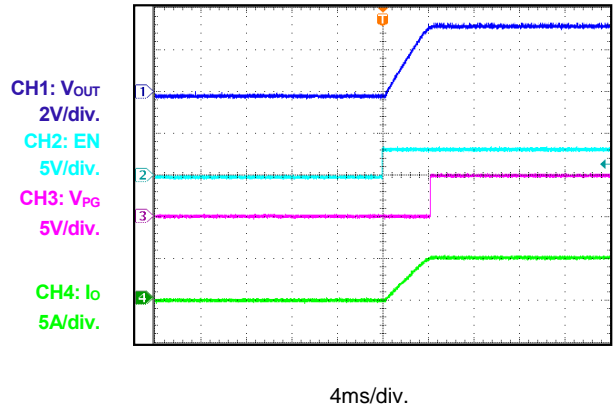

## TYPICAL PERFORMANCE CHARACTERISTICS (continued)

$V_{IN} = 24V$ ,  $V_{OUT} = 3.3V$ , External  $C_{OUT} = 22\mu F$ ,  $T_A = 25^\circ C$ , unless otherwise noted.

### EN Shutdown

$V_{IN} = 24V$   $V_{OUT} = 3.3V$   $I_{OUT} = 0A$

CH1:  $V_{OUT}$   
2V/div.  
CH2: EN  
5V/div.  
CH3:  $V_{PG}$   
5V/div.  
CH4:  $I_O$   
5A/div.

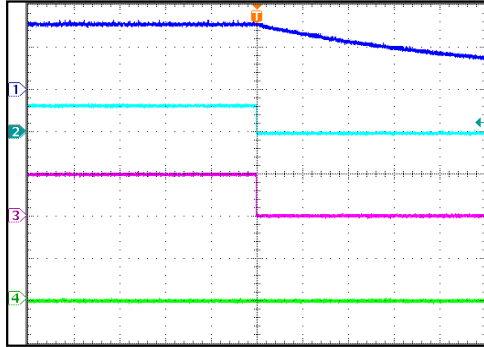

200ms/div.

### EN Shutdown

$V_{IN} = 24V$   $V_{OUT} = 3.3V$   $I_{OUT} = 5A$

CH1:  $V_{OUT}$   
2V/div.  
CH2: EN  
5V/div.  
CH3:  $V_{PG}$   
5V/div.  
CH4:  $I_O$   
5A/div.

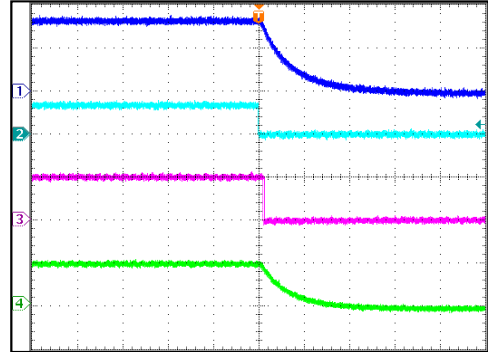

40µs/div.

### Steady State

$V_{IN} = 24V$   $V_{OUT} = 3.3V$   $I_{OUT} = 0A$

CH1:  $V_{OUT}/AC$   
50mV/div.  
CH2:  $V_{IN}$   
20V/div.  
CH4:  $I_O$   
5A/div.

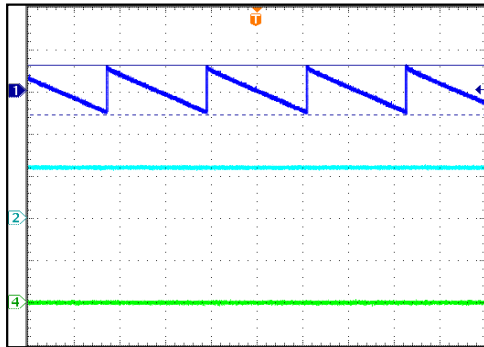

10ms/div.

### Steady State

$V_{IN} = 24V$   $V_{OUT} = 3.3V$   $I_{OUT} = 5A$

CH1:  $V_{OUT}/AC$   
50mV/div.  
CH2:  $V_{IN}$   
20V/div.  
CH4:  $I_O$   
5A/div.

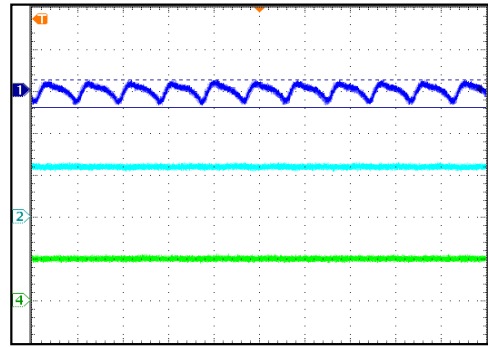

2µs/div.

### SCP Entry

$V_{IN} = 24V$   $V_{OUT} = 3.3V$   $I_{OUT} = 0A$

CH1:  $V_{OUT}$   
5V/div.  
CH2:  $V_{IN}$   
20V/div.  
CH3:  $V_{PG}$   
5V/div.  
CH4:  $I_O$   
5A/div.

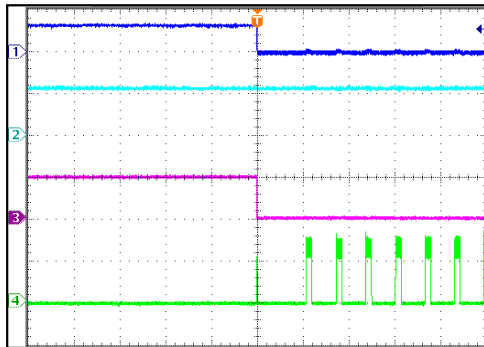

20ms/div.

### SCP Entry

$V_{IN} = 24V$   $V_{OUT} = 3.3V$   $I_{OUT} = 5A$

CH1:  $V_{OUT}$   
5V/div.  
CH2:  $V_{IN}$   
20V/div.  
CH3:  $V_{PG}$   
5V/div.  
CH4:  $I_O$   
5A/div.

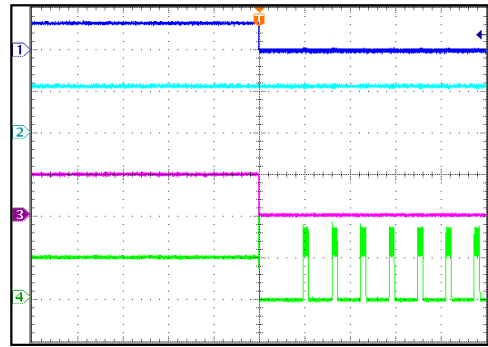

20ms/div.

**TYPICAL PERFORMANCE CHARACTERISTICS (continued)**
 $V_{IN} = 24V$ ,  $V_{OUT} = 3.3V$ , External  $C_{OUT}=22\mu F$ ,  $T_A = 25^\circ C$ , unless otherwise noted.

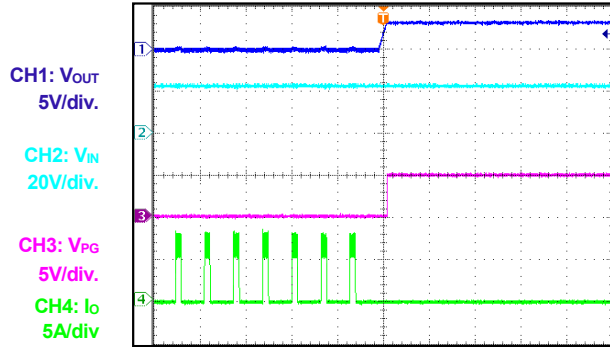
**SCP Recovery**
 $V_{IN} = 24V$   $V_{OUT} = 3.3V$   $I_{OUT} = 0A$ 

20ms/div.

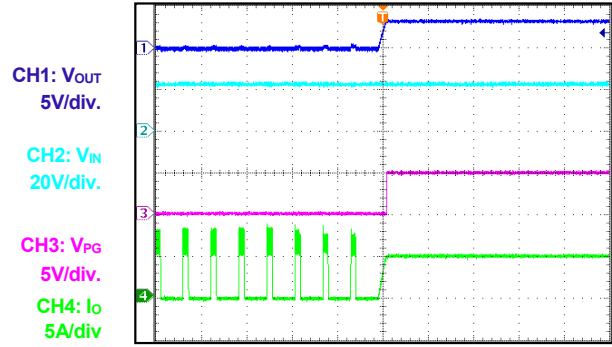
**SCP Recovery**
 $V_{IN} = 24V$   $V_{OUT} = 3.3V$   $I_{OUT} = 5A$ 

20ms/div.

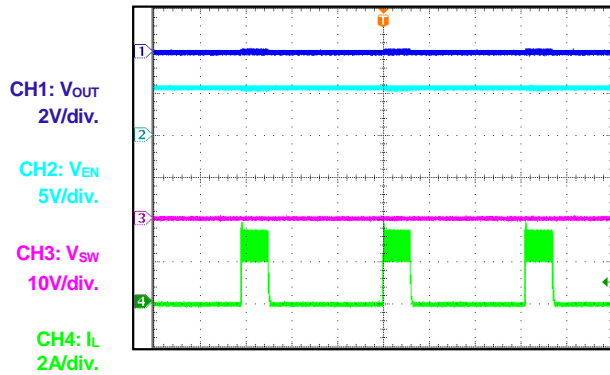
**SCP steady state**
 $V_{IN} = 24V$   $V_{OUT} = 3.3V$ 

400ms/div.

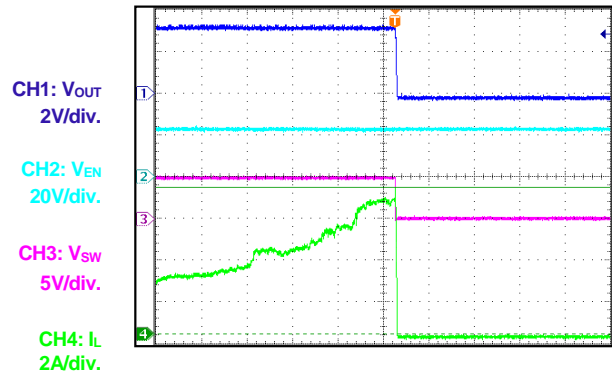
**Current Limit**
 $V_{IN} = 24V$   $V_{OUT} = 3.3V$ 

4ms/div.

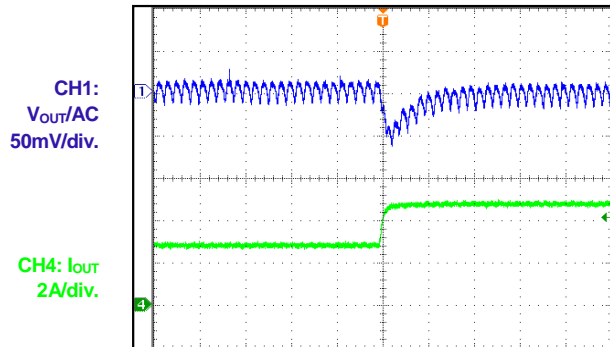
**Transient**
 $V_{IN} = 24V$   $V_{OUT} = 3.3V$   $I_{OUT} = 2.5A \rightarrow 5A$ 

10μs/div.

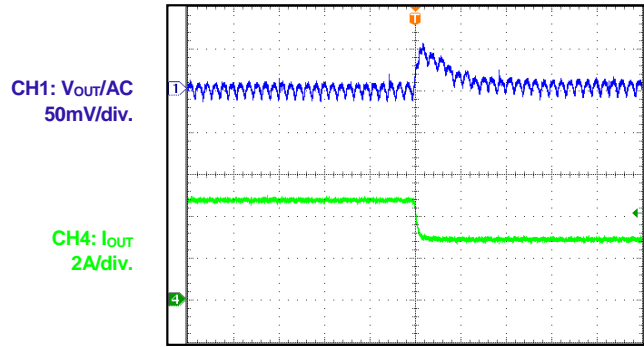
**Transient**
 $V_{IN} = 24V$   $V_{OUT} = 3.3V$   $I_{OUT} = 5A \rightarrow 2.5A$ 

10μs/div.

**EVM3550E-GLE-00A PCB**

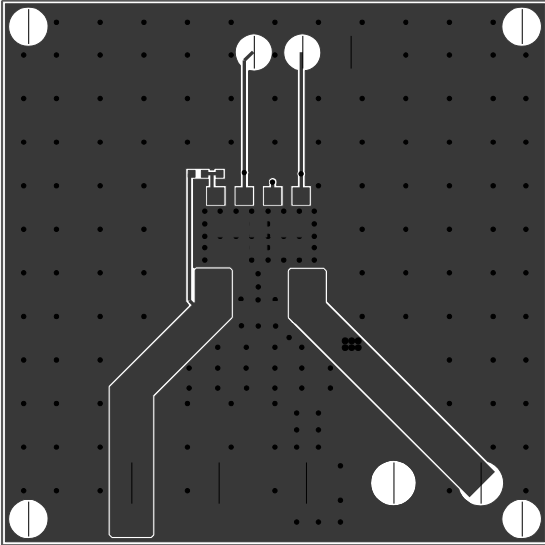

**Figure 1—Top Layer**

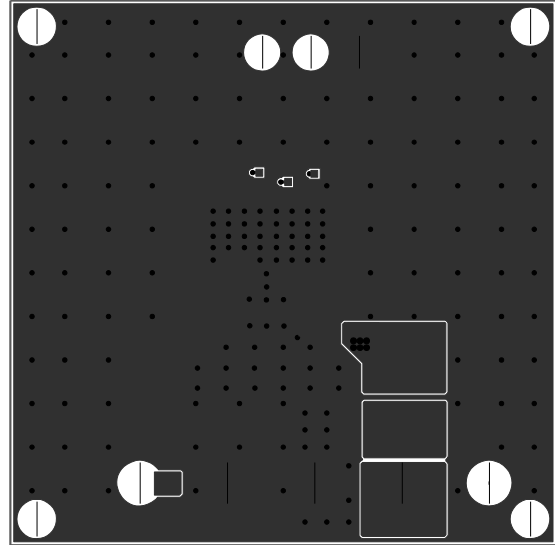

**Figure 2—Bottom Layer**

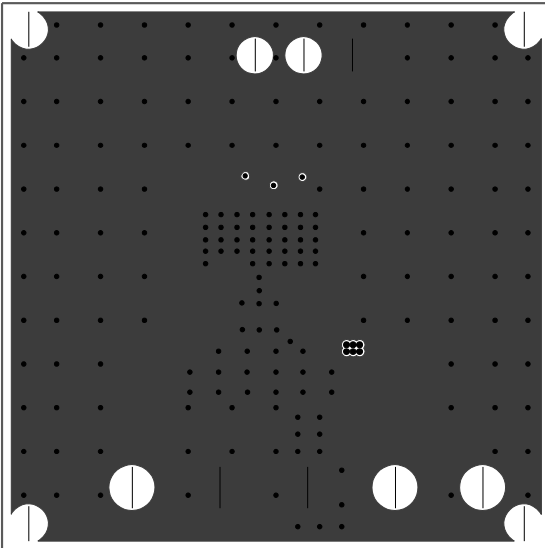

**Figure 3—Inner1 Layer**

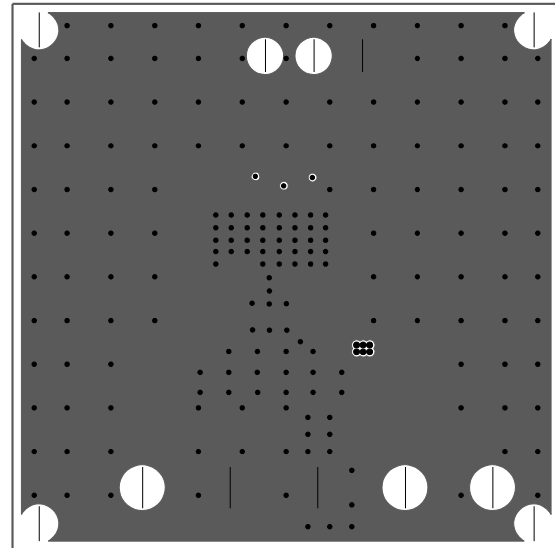

**Figure 4—Inner2 Layer**

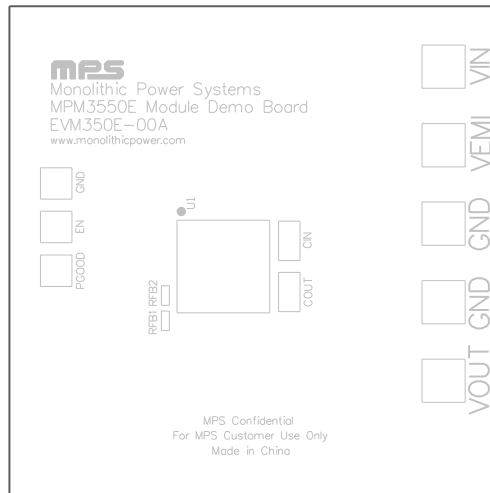

**Figure 5—Top Silk Layer**

## APPLICATION INFORMATION

### Switching Frequency

The input voltage is feed-forwarded to the on-time one shot timer through the internal  $R_{FREQ}$  100k resistor. The duty ratio remains at  $V_{OUT}/V_{IN}$ . Hence the switching frequency is fairly constant over the input voltage range. The switching frequency can be set as:

$$F_{sw}(kHz) = \frac{10^6}{\left[ \frac{96 \times R_{FREQ} (k\Omega)}{V_{IN}} + t_{DELAY} (ns) \right] \times \frac{V_{IN}}{V_{OUT}}} \quad (1)$$

Where  $t_{DELAY}$  is the comparator delay (~20ns).

### Output Voltage Setting

The MPM3550E has internal FB divider resistors to set a default 3.3V output voltage. The upper divider resistor is 31.6k $\Omega$ , and the lower divider resistor is 10k $\Omega$ .

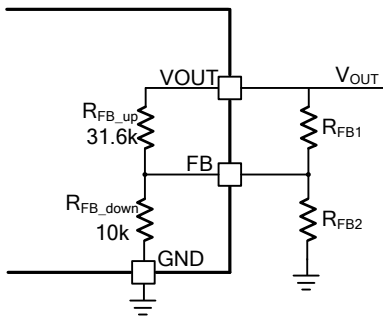

**Figure 6: FB resistors for setting output voltage**

The MPM3550E regulate its FB pin to 0.815V. By connecting an external resistor, the output can be set to any voltage from 1.0V to 12.0V. For  $V_{OUT}$  less than 3.3V applications, connect an appropriate resistor  $R_{FB1}$  between the FB and  $V_{OUT}$  pins. For  $V_{OUT}$  over 3.3V applications, connect an appropriate resistor  $R_{FB2}$  between the FB and GND pins. The formulas for calculating rough value of this resistor are:

$$R_{FB1} = \frac{31.6/620 \times (V_{OUT} - 0.815)}{3.3 - V_{OUT}}, V_{OUT} < 3.3V \quad (2)$$

$$R_{FB2} = \frac{31.6/620 \times 0.815}{V_{OUT} - 3.3}, V_{OUT} > 3.3V \quad (3)$$

For some typical applications, Table 1 provides the corresponding  $R_{FB}$  values.

**Table 1— $R_{FB}$  Values to Typical  $V_{OUT}$**

$V_{OUT}$ (V)	$R_{FB1}$ (k $\Omega$ )	$R_{FB2}$ (k $\Omega$ )
1.0	2.4	NS
1.2	5.49	NS
1.5	11.5	NS
1.8	19.6	NS
2.5	63.4	NS
3.3	NS	NS
5	NS	14.3

### Under Voltage Lock Out Point Setting

The MPM3550E has 4.0V built-in UVLO turn-on threshold with a 900mV hysteresis. When supply voltage exceeds the UVLO turn-on threshold voltage, the module powers up. It shuts off when the supply voltage falls below the UVLO turn-off threshold voltage. External resistor between EN and GND as shown in Figure 7 can be used to get higher equivalent UVLO threshold.

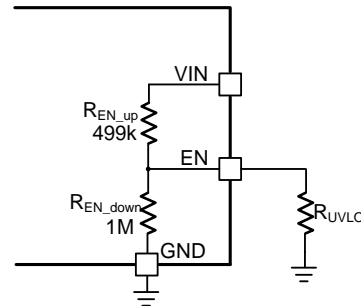

**Figure 7: Adjustable UVLO with External Resistor**

The resistor for adjusting the UVLO can be computed from below equation:

$$R_{UVLO} (k\Omega) = \frac{623.75}{V_{IN} - 1.87} \quad (4)$$

The calculated resistance may need fine tuning by bench test.



## QUICK START:

1. Connect the positive and negative terminals of the load to the VOUT and GND pins, respectively.
2. Preset the power supply output between 4.5V and 36V, and then turn off the power supply.
3. Connect the positive and negative terminals of the power supply output to the VIN and GND pins, respectively.
4. Turn the power supply on. The board will automatically start up.
5. To use the Enable function: Drive EN higher than 1.25V to turn on the regulator, or less than 0.86V to turn it off

**NOTICE:** The information in this document is subject to change without notice. Users should warrant and guarantee that third party Intellectual Property rights are not infringed upon when integrating MPS products into any application. MPS will not assume any legal responsibility for any said applications.