



EVM3570E-LD-00A

75V, 0.3A, High Efficiency, Synchronous Step-Down Power Module With Integrated Inductor

DESCRIPTION

EVM3570E-LD-00A Evaluation Board is based on MPS's MPM3570E. The MPM3570E is a high density, non-isolated DC-DC power module for space sensitive applications. The module offers a very compact solution to achieve 0.3A output current over a 4.5V to 75V wide input supply range, and can provide an adjustable output voltage from 1.0V to 12.0V via an external FB resistor (Default 3.3V output).

The MPM3570E integrates switching controller, power switches, inductors, a modest amount of input and output capacitors and all support components with an advanced 10x10x4.2mm size. And it requires a minimal number of standard external components. This compact solution significantly helps in system design and productivity by offering greatly simplified board design, layout and manufacturing requirements.

ELECTRICAL SPECIFICATION (1)

Parameter	Symbol	Value	Units
Input Voltage	V _{IN}	12	V
Output Voltage	V _{OUT}	3.3	V
Output Current	I _{OUT}	0.3	A

Notes:

1) For different Input/output voltage specs and different output capacitor/inductor may need change the application circuit parameters.

FEATURES

- Integrated Inductor, Switches, Controller
- High Efficiency Synchronous Mode Control
- Low Component Count and Small Size
- Ease of Design and Fastest Time to Market
- Wide 4.5V to 75V Operating Input Range
- Output Adjustable from 1.0V to 12.0V
- 0.3A Output Current
- 40µA Quiescent Current
- Ultra-fast Transient Response
- Internal Fixed Soft-Start Time
- Power OK Indicator
- Non-latch OCP and UVLO
- Thermal Shutdown Protection
- Remote Enable Control
- Dimension: 10mmx10mmx4.2mm
- Weight: 0.80g
- Operating Temperature: -40°C to +125°C
- CISPR25 Class 5 Compliant

APPLICATIONS

- Automotive Systems
- Industrial Supplies
- Telecom and Networking Systems
- Distributed Power and POL Systems

All MPS parts are lead-free, halogen free, and adhere to the RoHS directive. For MPS green status, please visit MPS website under Quality Assurance.

"MPS" and "The Future of Analog IC Technology" are Registered Trademarks of Monolithic Power Systems, Inc.

EVM3570E-LD-00A EVALUATION BOARD



(L x W x H) 63.7mm x 63.7mm x 6.4mm

Board Number	MPS IC Number
EVM3570E-LD-00A	MPM3570EGLD

Efficiency vs. I_{OUT}

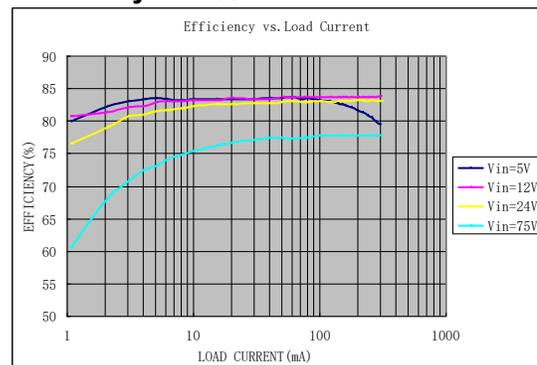

EVALUATION BOARD SCHEMATIC

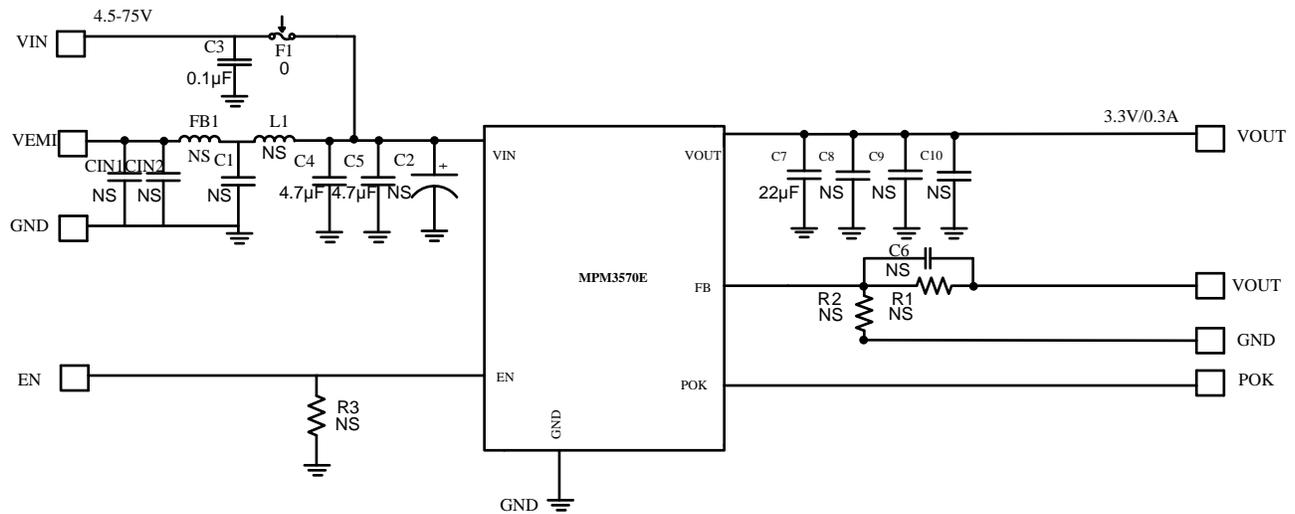

EVM3570E-QV-00A BILL OF MATERIALS

Item	Qty	Designator	Value	Description	Package	Manufacture	Manufacture_PN
1	1	C3	0.1µF	Ceramic Capacitor;100V; X7R	603	muRata	GRM188R72A104K A35D
2	2	C4,C5	4.7µF	Ceramic Cap., 100V, X7S	1210	TDK	C3225X7S2A475K
3	1	C7	22µF	Ceramic Cap., 16V, X7R	1210	MuRata	GRM32ER71C226 KEA8L
4	8	CIN1,CIN2,C1,C 2,C6,C8,C9,C10	NS				
5	1	F1	0	Film Resistor;1%;	1206	Yageo	RC1206FR-070RL
6	3	R1, R2, R3	NS				
7	1	U1		DC-DC Module	LGA10X1 0	MPS	MPM3570E_R4
8	1	CN1		Connector; 2*20; 2.54mm; 90°排针		Any	
9	5	VIN, GND, VOUT, GND,VEMI,		2.0 Golden Pin		Any	
10	3	EN, POK, GND		1.0 Golden Pin		Any	

EVB TEST RESULTS

$V_{IN} = 12V$, $V_{OUT} = 3.3V$, $T_A = +25^{\circ}C$, unless otherwise noted.

Efficiency vs. I_{out}

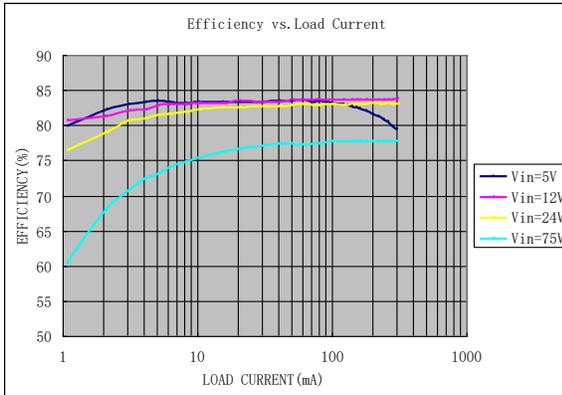

Input current vs. Output current

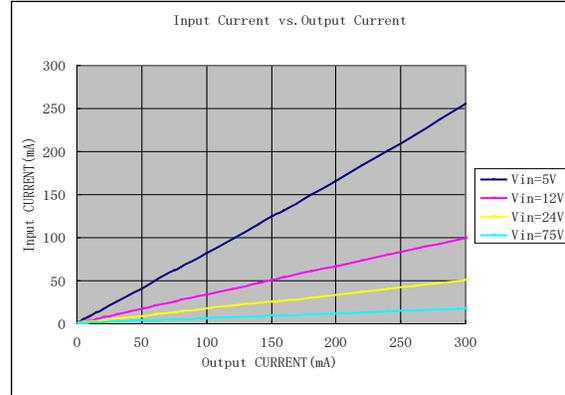

Load Regulation vs. I_{out}

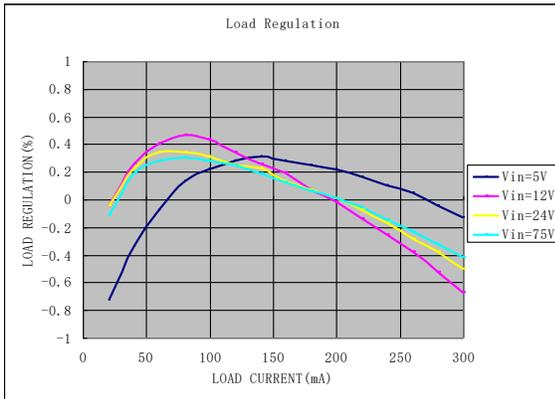

Line Regulation vs. V_{in}

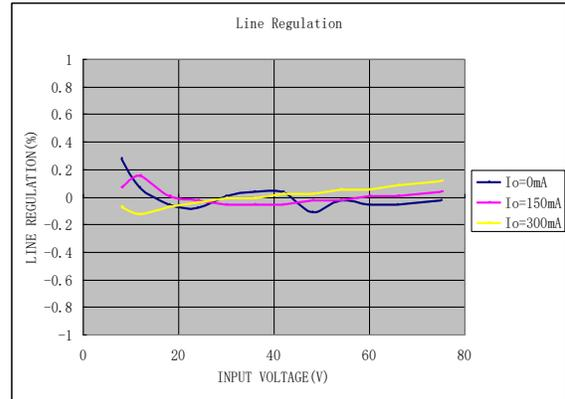

Output ripple vs. I_{out}

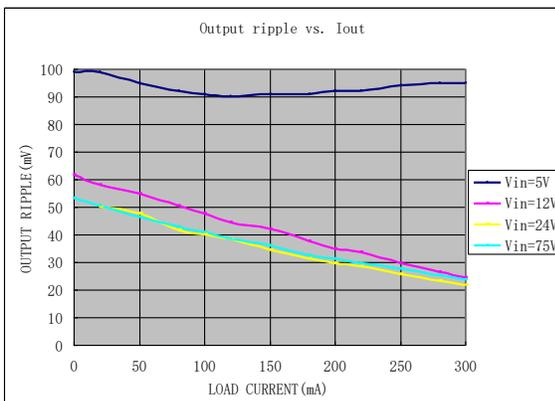

Power dissipation vs. I_{out}

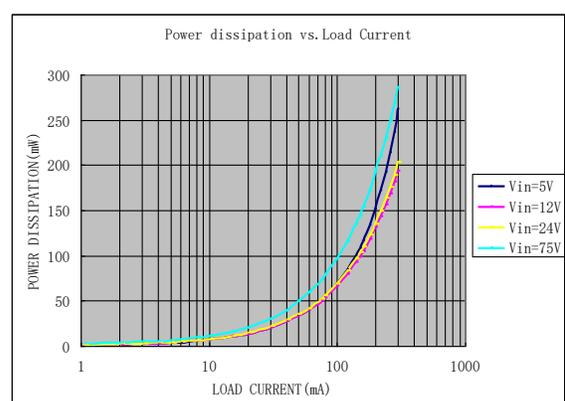

EVB TEST RESULTS *(continued)*

$V_{IN} = 12V$, $V_{OUT} = 3.3V$, $T_A = +25^{\circ}C$, unless otherwise noted.

Vo Ripple

$I_{OUT} = 0A$

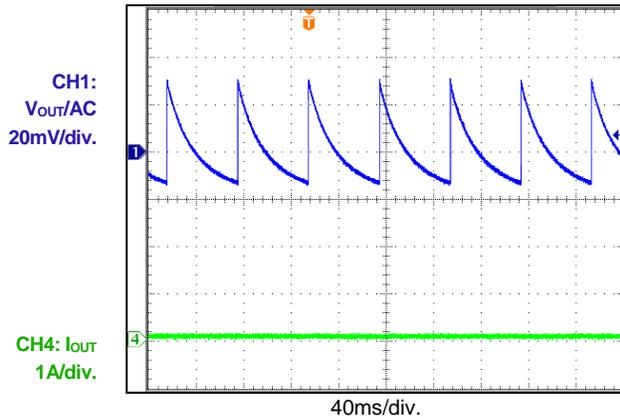

Vo Ripple

$I_{OUT} = 0.3A$

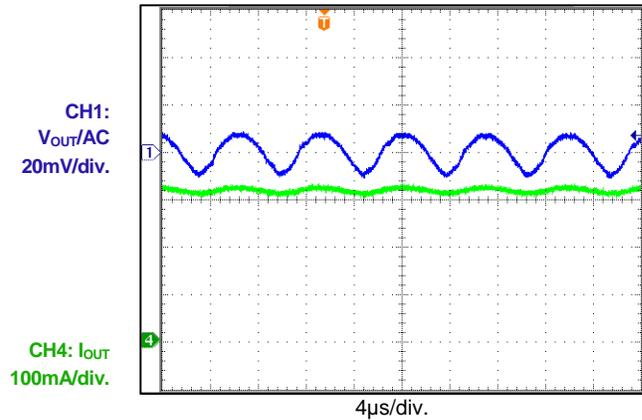

Vin Start Up

$I_{OUT} = 0A$

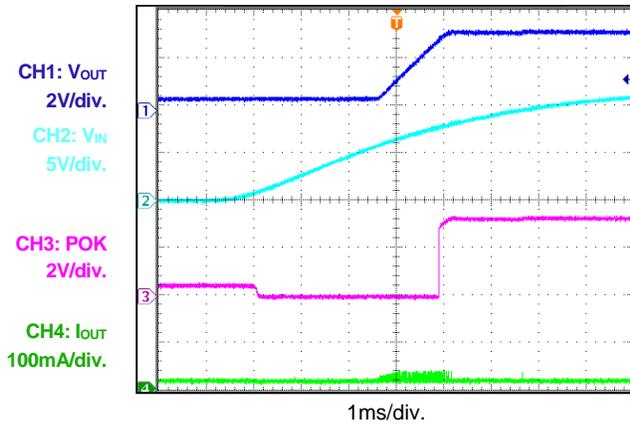

Vin Start Up

$I_{OUT} = 0.3A$

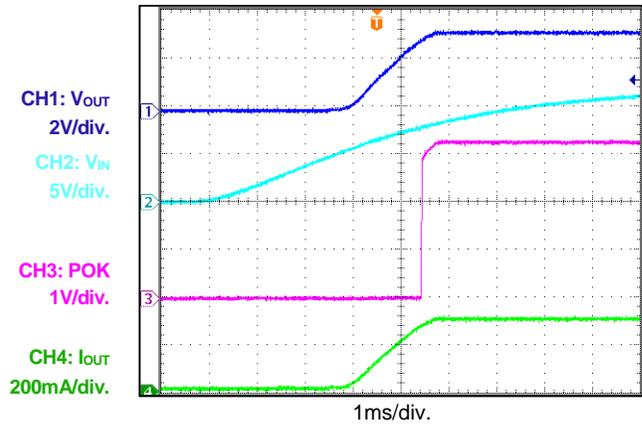

Vin Shutdown

$I_{OUT} = 0A$

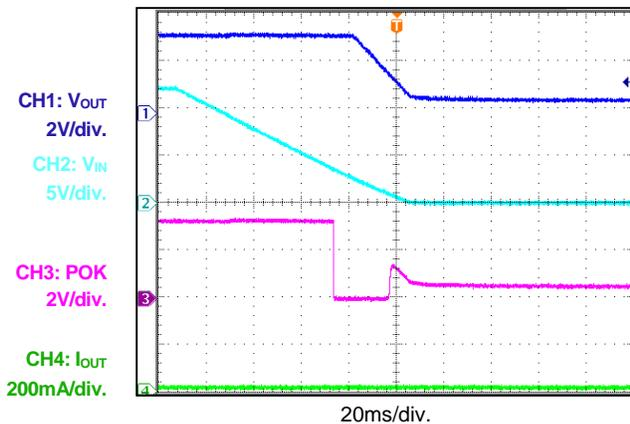

Vin Shutdown

$I_{OUT} = 0.3A$

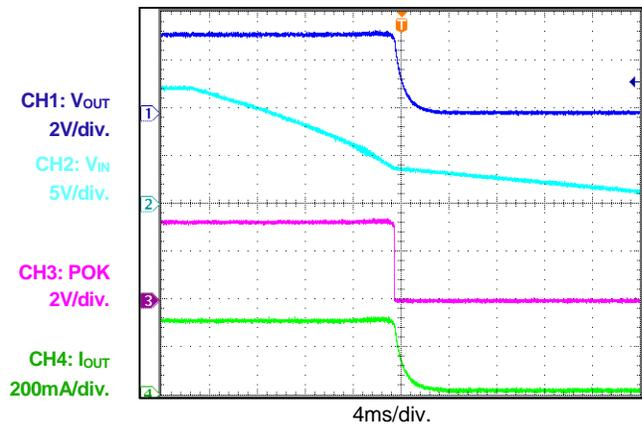

EVB TEST RESULTS *(continued)*

$V_{IN} = 12V$, $V_{OUT} = 3.3V$, $T_A = +25^{\circ}C$, unless otherwise noted.

EN Start Up

$I_{OUT} = 0A$

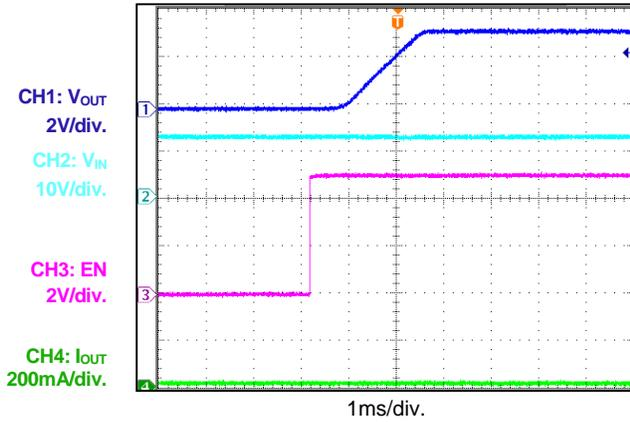

EN Start Up

$I_{OUT} = 0.3A$

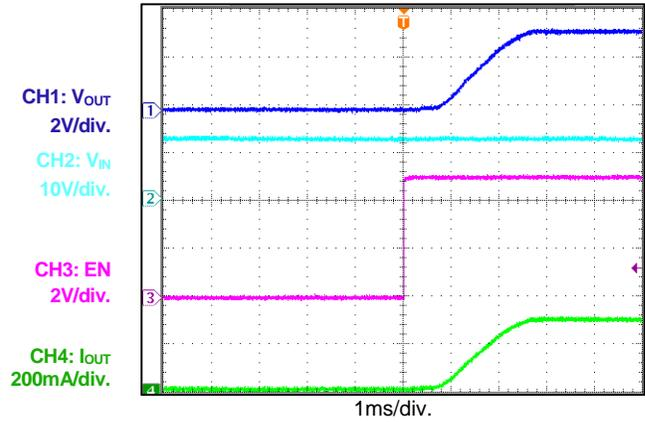

EN Shutdown

$I_{OUT} = 0A$

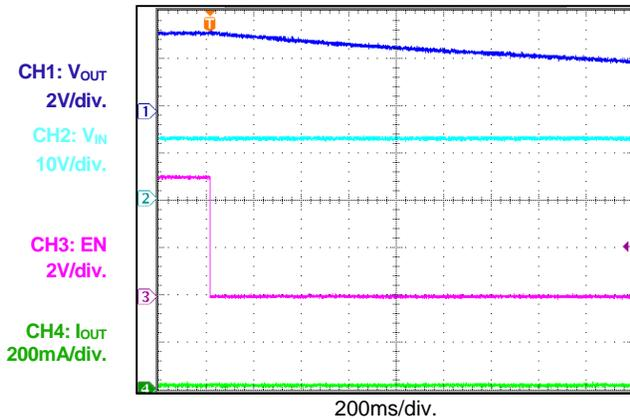

EN Shutdown

$I_{OUT} = 0.3A$

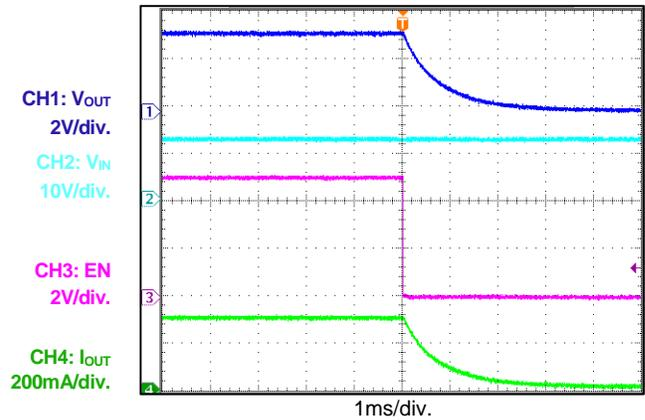

EN On/Off Cycle

$I_{OUT} = 0A$

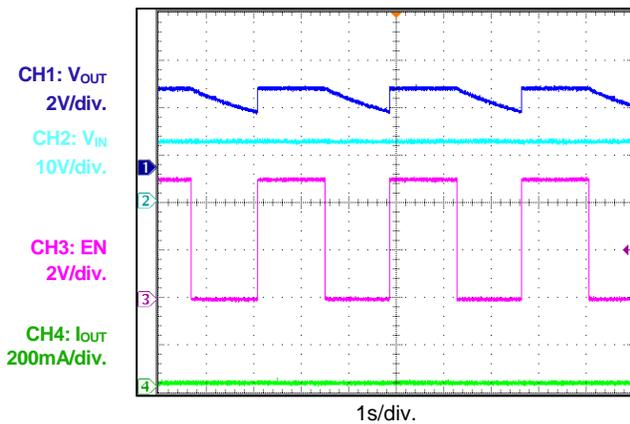

EN On/Off Cycle

$I_{OUT} = 0.3A$

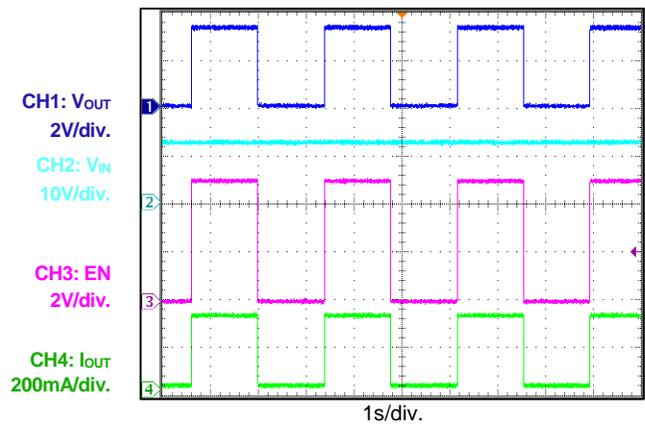

EVB TEST RESULTS *(continued)*

$V_{IN} = 12V$, $V_{OUT} = 3.3V$, $T_A = +25^{\circ}C$, unless otherwise noted.

SCP Steady State

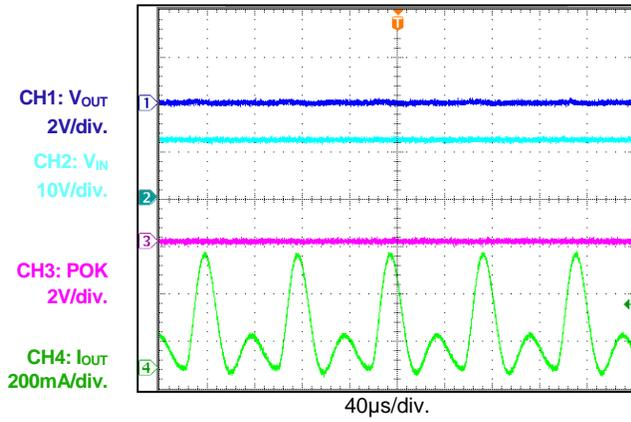

PRINTED CIRCUIT BOARD LAYOUT

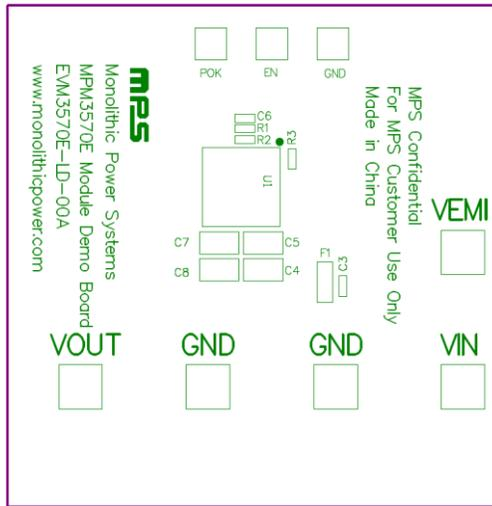

Figure 1: Top Silk Layer

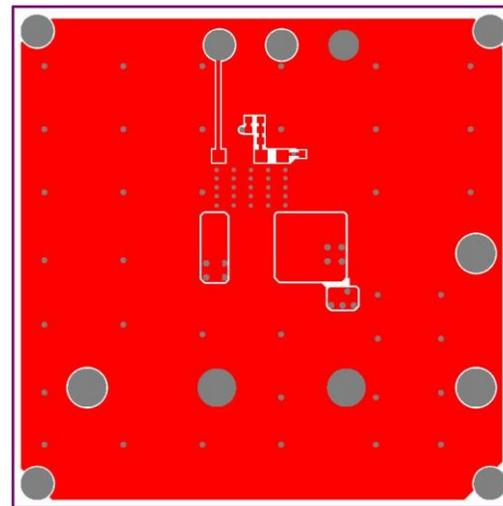

Figure 2: Top Layer

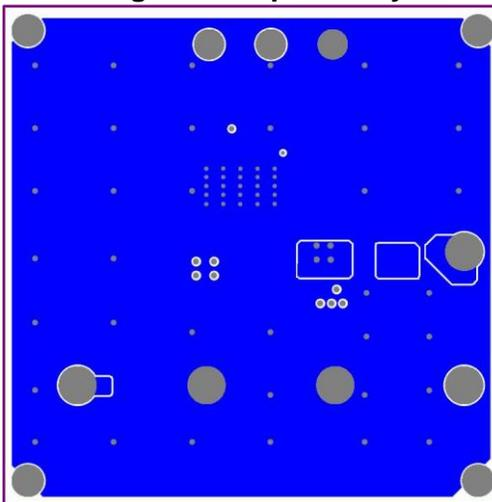

Figure 3: Bottom Layer

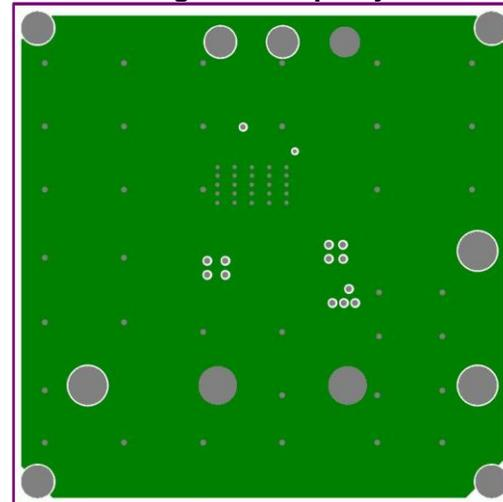

Figure 4: Inner1 Layer

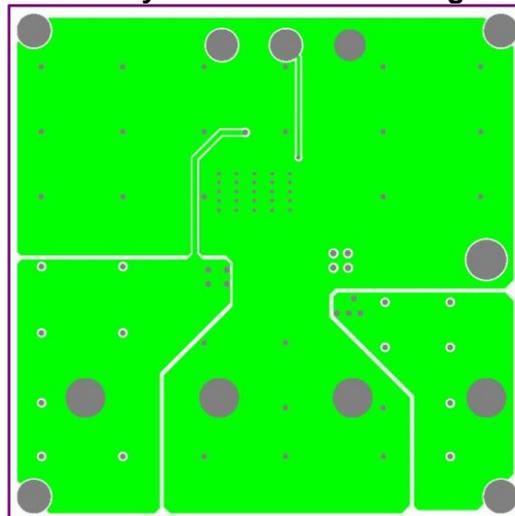

Figure 5: Inner2 Layer

QUICK START GUIDE

1. Preset Power Supply to 12V.
2. Turn Power Supply off.
3. Connect Power Supply terminals to:
 - a. Positive (+): VIN
 - b. Negative (-): GND
4. Connect Load to:
 - a. Positive (+): VOUT
 - b. Negative (-): GND
5. Turn Power Supply on after making connections. The board will automatically start up.
6. To use the Enable function, apply a digital input to the EN pin. Drive EN higher than 1.2V to turn on the regulator, or less than 1V to turn it off.

NOTICE: The information in this document is subject to change without notice. Please contact MPS for current specifications. Users should warrant and guarantee that third party Intellectual Property rights are not infringed upon when integrating MPS products into any application. MPS will not assume any legal responsibility for any said applications.