

DESCRIPTION

The EVM3610-QV-00A is an evaluation board for MPM3610, a synchronous rectified, step-down Mini-Module regulator with built-in power MOSFETs, inductor and two capacitors.

The evaluation board can deliver a 1.2A continuous output current with excellent load and line regulation over a wide input supply range. External AAM pin provides selectable power save mode or force PWM mode.

Full protection features include over-current protection and thermal shut down.

The MPM3610 is available in a space-saving QFN20 (3mm x5mmx1.6mm) package.

ELECTRICAL SPECIFICATION

Parameter	Symbol	Value	Units
Input Voltage	V_{IN}	4.5 – 21	V
Output Voltage	V_{OUT}	3.3	V
Output Current	I_{OUT}	1.2	A

FEATURES

- Complete Switch Mode Power Supply
- 4.5V-to-21V Operating Input Range
- 1.2A Continuous Load Current
- Low $R_{DS(ON)}$ Internal Power MOSFETs
- Fixed 2MHz Switching Frequency
- External AAM pin for Power-Save Mode Programming
- OCP Protection and Hiccup
- Thermal Shutdown
- Output Adjustable from 0.8V
- Available in QFN20 (3x5x1.6mm) Package

APPLICATIONS

- Industrial Controls
- Medical and Imaging Equipment
- Telecom Applications
- Distributed Power Systems

All MPS parts are lead-free and adhere to the RoHS directive. For MPS green status, please visit MPS website under Products, Quality Assurance page.

"MPS" and "The Future of Analog IC Technology" are registered trademarks of Monolithic Power Systems, Inc.

EVM3610-QV-00A EVALUATION BOARD

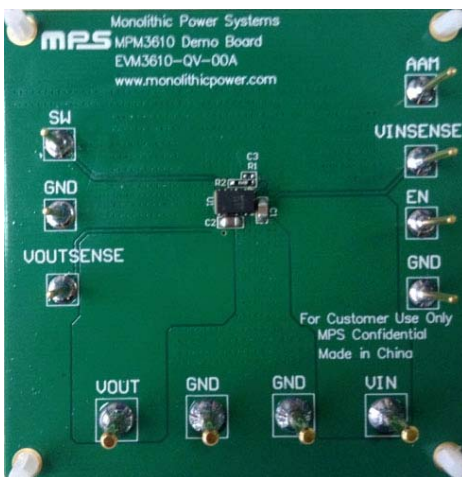

Board Number	MPS IC Number
EVM3610-QV-00A	MPM3610GQV

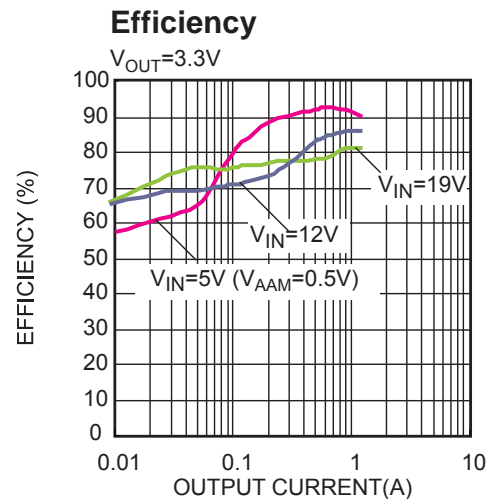

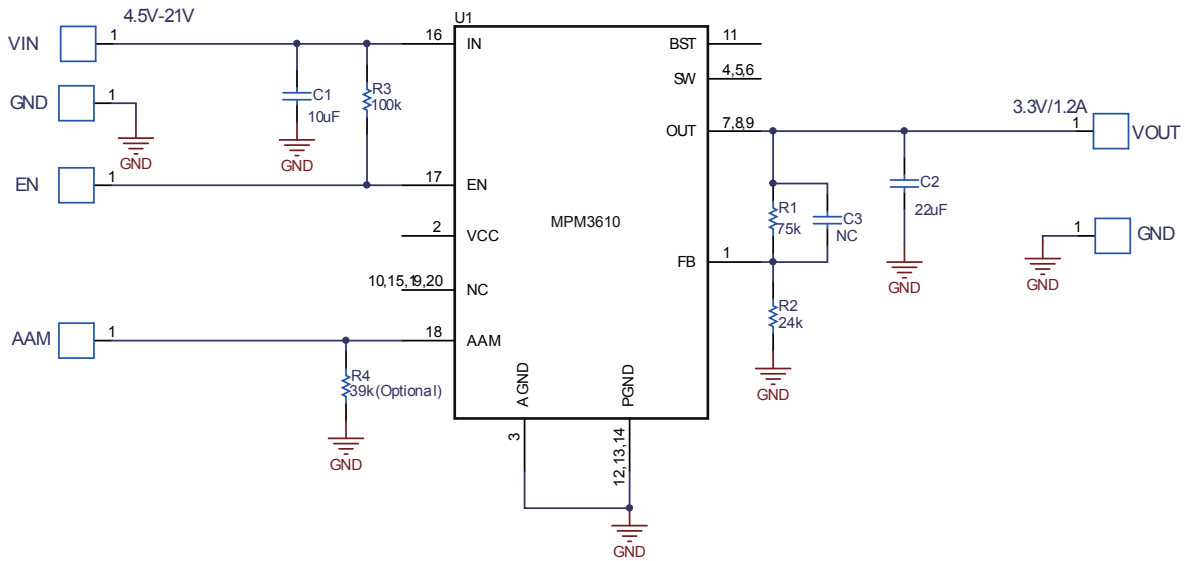
EVALUATION BOARD SCHEMATIC

EVM3610-QV-00A BILL OF MATERIALS

Qty	Ref	Value	Description	Package	Manufacturer	Manufacturer P/N
1	C1	10µF	Ceramic Cap,25V,X5R	0805	muRata	GRM21BR61E106KA73L
1	C2	22µF	Ceramic Cap,16V,X5R	0805	muRata	GRM219R61C226ME15L
1	C3	NS		0402		
1	R1	75k	Thick Film Res., 1%	0402	Any	
1	R2	24k	Thick Film Res., 1%	0402	Any	
1	R3	100k	Thick Film Res., 1%	0402	Any	
1	R4	39k	Thick Film Res., 1%	0402	Any	
1	U1	MPM3610	Synchronous Step-Down Mini-Module	QFN-20	MPS	MPM3610GQV

EVB TEST RESULTS

Performance waveforms are tested on the evaluation board.

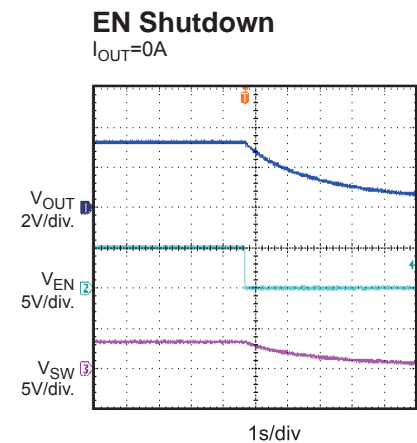
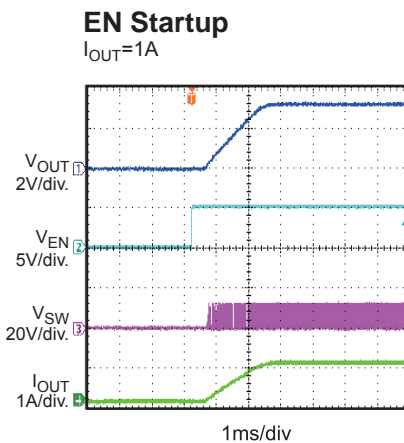
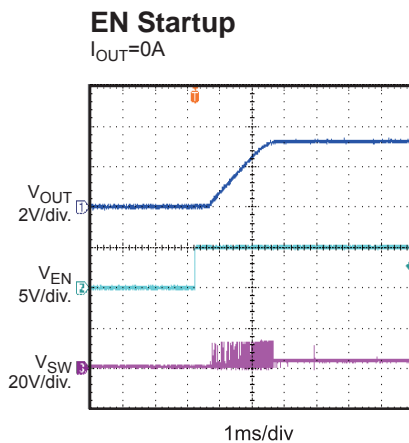
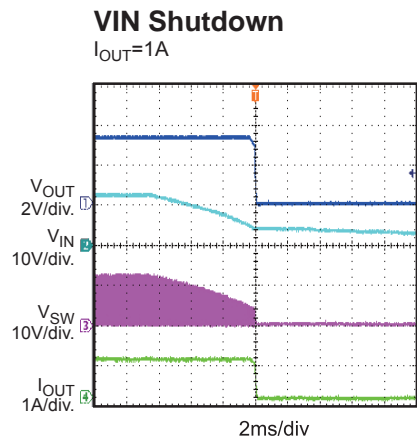
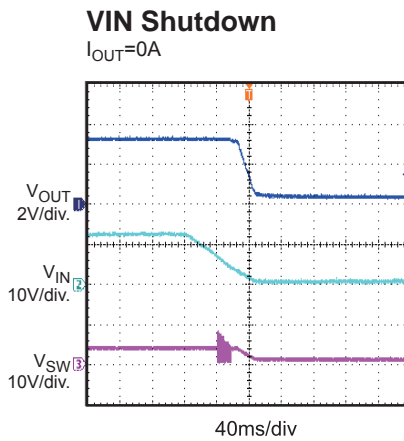
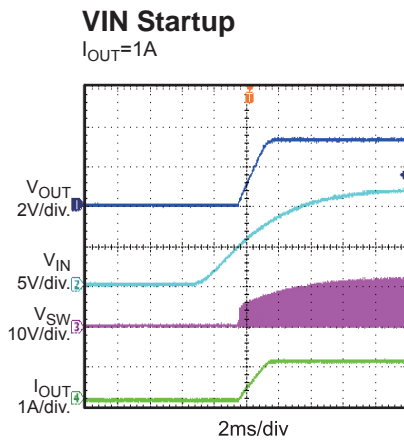
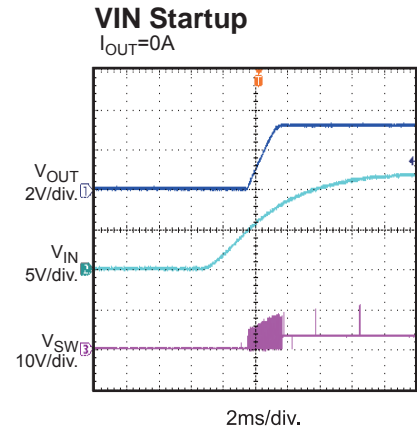
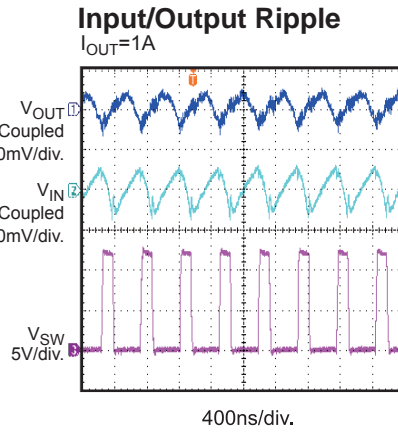
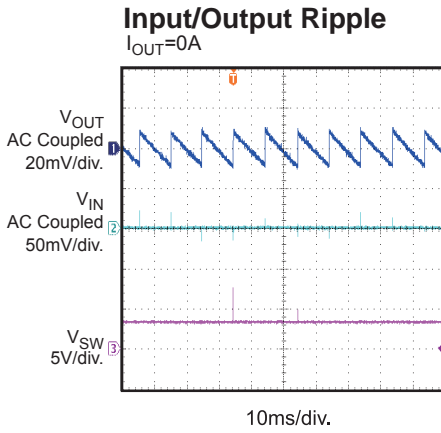
$V_{IN} = 12V$, $V_{OUT} = 3.3V$, $T_A = 25^\circ C$, unless otherwise noted.



EVB TEST RESULTS *(continued)*

Performance waveforms are tested on the evaluation board.
 $V_{IN} = 12V$, $V_{OUT} = 3.3V$, $T_A = 25^\circ C$, unless otherwise noted.

EN Shutdown

$I_{OUT} = 1A$

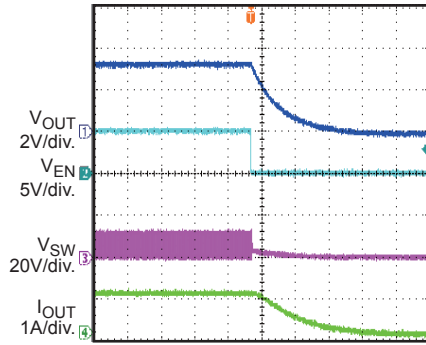

40 μ s/div.

Transient Response

$I_{OUT} = 0.5A$ to $1A$

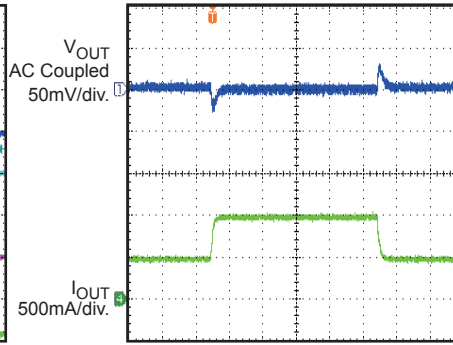

100 μ s/div.

Short Circuit Entry

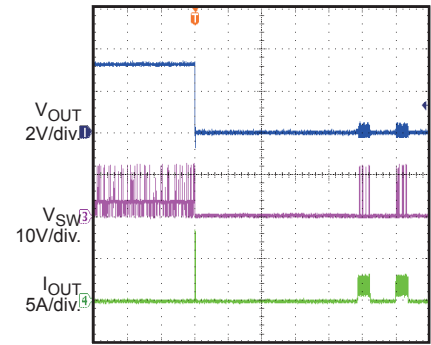

4ms/div.

Short Circuit Steady State

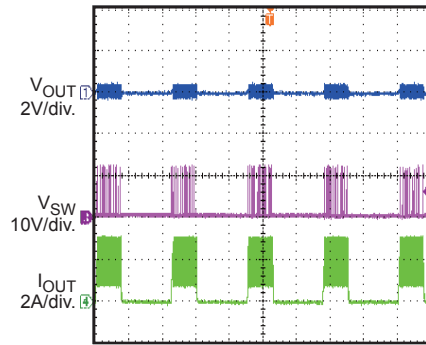

2ms/div.

Short Circuit Recovery

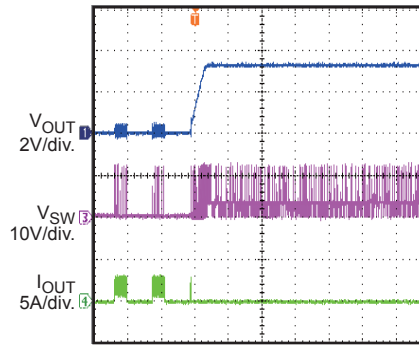

4ms/div.

PRINTED CIRCUIT BOARD LAYOUT

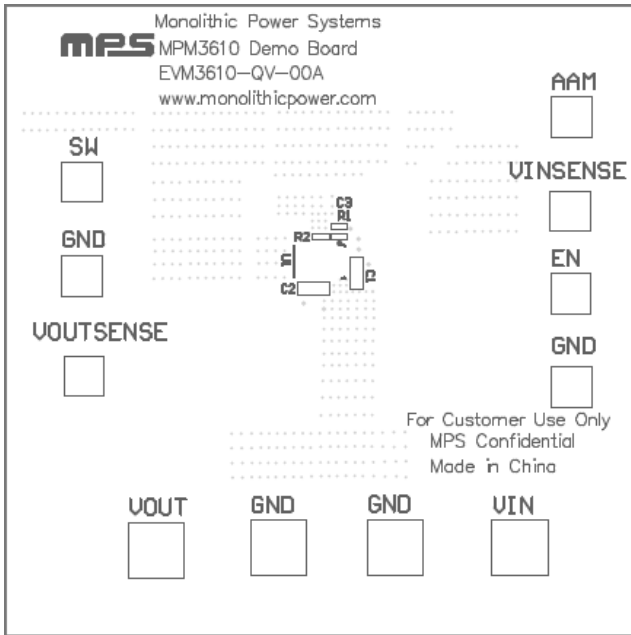

Figure 1—Top Silk Layer

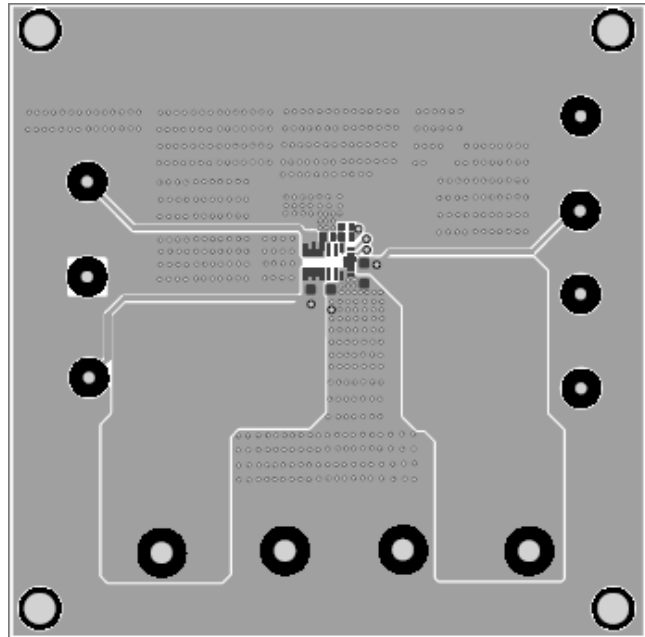

Figure 2—Top Layer

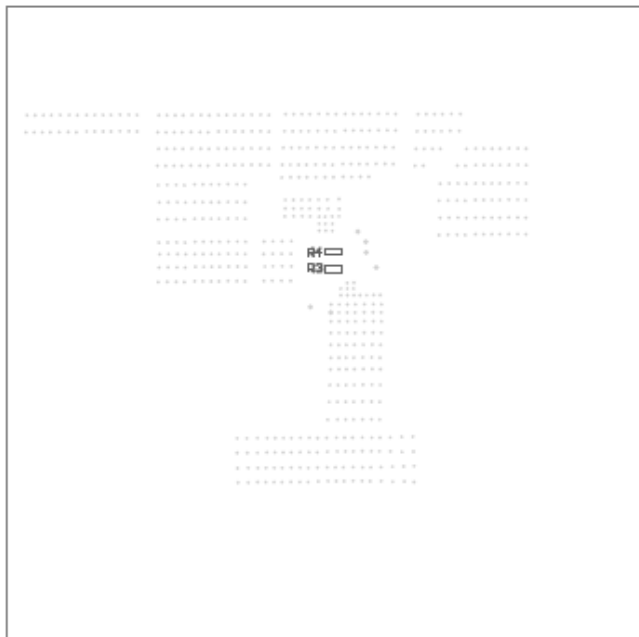

Figure 3—Bottom Silk Layer

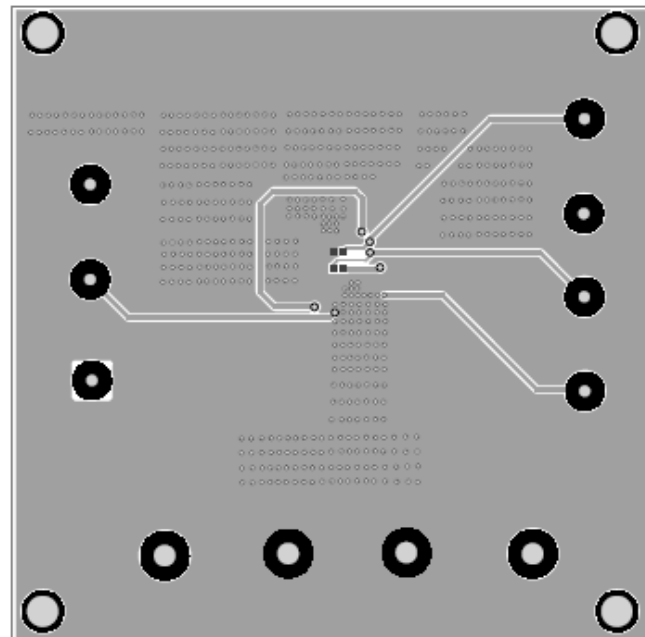

Figure 4—Bottom Layer

QUICK START GUIDE

1. Connect the positive and negative terminals of the load to the VOUT and GND pins, respectively.
2. Preset the power supply output between 4.5V and 21V, and then turn off the power supply.
3. Connect the positive and negative terminals of the power supply output to the VIN and GND pins, respectively.
4. Turn the power supply on. The board will automatically start up.
5. To use the Enable function, apply a digital input to the EN pin. Drive EN higher than 1.4V to turn on the regulator, or less than 1.25V to turn it off.
6. Float AAM pin or drive AAM to a high level voltage to set MPM3610 work at force PWM mode.

NOTICE: The information in this document is subject to change without notice. Please contact MPS for current specifications. Users should warrant and guarantee that third party Intellectual Property rights are not infringed upon when integrating MPS products into any application. MPS will not assume any legal responsibility for any said applications.