



# EVM3650-QW-00A

## 17V Input, 5A, Step-Down Converter Module Evaluation Board

### DESCRIPTION

The EVM3650-QW-00A evaluation board is designed to demonstrate the capabilities of MPS's MPM3650, a fully integrated, high-frequency, synchronous, rectified, step-down power module with an internal inductor. The MPM3650 offers a very compact solution to achieve 5A of continuous output current over a wide input voltage range with excellent load and line regulation. The MPM3650 offers synchronous mode operation for higher efficiency over the output current load range.

Constant-on-time (COT) control operation provides very fast transient response and easy loop design, as well as very tight output regulation. Full protection features include SCP, OCP, UVP, and thermal shutdown.

### ELECTRICAL SPECIFICATIONS

Parameter	Symbol	Value	Units
Input voltage	$V_{IN}$	2.75 to 17	V
Output voltage	$V_{OUT}$	1	V
Output current	$I_{OUT}$	5	A

### FEATURES

- Wide 2.75V to 17V Operating Input Range
- 5A Output Current
- High Efficiency with DCM at Light Load
- Output Adjustable from 0.6V
- High-Efficiency Synchronous Mode Operation
- Supports Pre-Biased Start-Up
- Fixed 1200kHz Switching Frequency
- Externally Programmable Soft-Start Time
- EN and Power Good for Power Sequencing
- Over-Current Protection and Hiccup Mode
- Thermal Shutdown
- Available in a QFN-24 (4mmx6mmx1.6mm) Package

### APPLICATIONS

- FPGA Power Systems
- Optical Modules
- Telecom
- Networking
- Industries Equipment

All MPS parts are lead-free, halogen-free, and adhere to the RoHS directive. For MPS green status, please visit the MPS website under Quality Assurance. "MPS", the MPS logo, and "Simple, Easy Solutions" are registered trademarks of Monolithic Power Systems, Inc. or its subsidiaries. ADAM (Analog Digital Adaptive Modulation), AAM (...) are trademarks of Monolithic Power Systems, Inc.

## EVM3650-QW-00A EVALUATION BOARD



(LxWxH) 63.5mmx63.5mmx1.6mm

Board Number	MPS IC Number
EVM3650-QW-00A	MPM3650GQY

### Efficiency VS. Load Current

$V_{IN} = 12V$

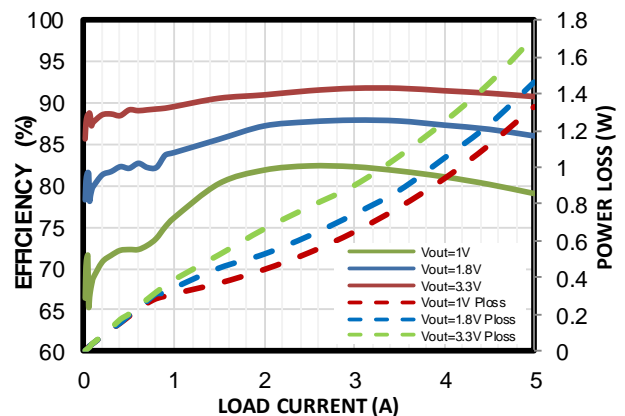

## QUICK START GUIDE

1. Preset the power supply to  $2.75V \leq V_{IN} \leq 17V$ .
2. Turn the power supply off.
3. Connect the power supply terminals to:
  - a. Positive (+): VIN
  - b. Negative (-): GND
4. Connect load ( $\leq 5A$ ) to:
  - a. Positive (+): VOUT
  - b. Negative (-): GND
5. Turn the power supply on after connecting the terminals. The board should start up automatically.

## EVALUATION BOARD SCHEMATIC

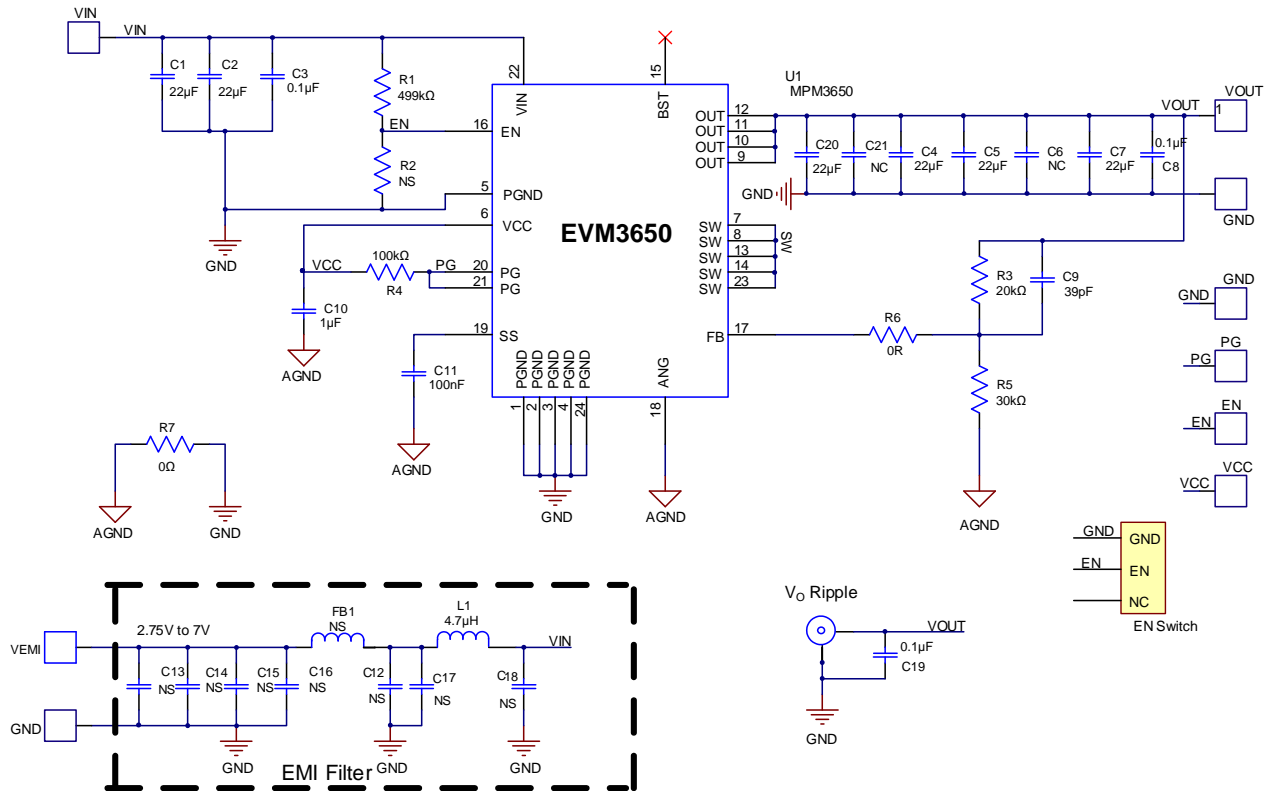

**EVM3860-QW-00A BILL OF MATERIALS**

Qty	Ref	Value	Description	Package	Manufacturer	Manufacturer PN
6	C1, C2, C4, C5, C20, C7	22 $\mu$ F	Ceramic capacitor, 25V, X5R	0805	Murata	GRM21BR61E226ME44L
4	C3, C8, C11, C19	0.1 $\mu$ F	Ceramic capacitor, 25V, X5R	0402	Würth	885012105018
1	C10	1 $\mu$ F	Ceramic capacitor, 25V, X5R	0402	Murata	GRM155R61E105KA12D
1	C9	39pF	Ceramic capacitor, 50V, C0G	0402	Murata	GRM1555C1H390JA01D
1	R1	499k $\Omega$	Film resistor, 1%, 0402, 499k $\Omega$	0402	Yageo	RC0402FR-07499KL
1	R4	100k $\Omega$	Film resistor, 1%, 0402, 100k $\Omega$	0402	Yageo	RC0402FR-07100KL
2	R7, R6	0R	Film resistor, 1%, 0402, 0R	0402	Yageo	RC0402FR-070RL
1	R3	20k $\Omega$	Film resistor, 1%, 0402, 20k $\Omega$	0402	Yageo	RC0402FR-0720KL
1	R5	30k $\Omega$	Film resistor, 1%, 0402, 30k $\Omega$	0402	Yageo	RC0402FR-0730KL
1	EN	3 pins	3-pin, single-row, straight socket header	DIP	Würth	61300311821
1	V <sub>o</sub> Ripple	N/A	SMA mount straight jack, VOUT/AC test component	DIP	Würth	60312002114503
5	VIN, VEMI, GND x 2, VOUT	$\phi$ 2.0	$\phi$ 2.0 copper pin	DIP	N/A	N/A
4	EN, GND, VCC, PG	$\phi$ 1.0	$\phi$ 1.0 copper pin	DIP	N/A	N/A
1	U1	N/A	Power module	QFN-24 (4mmx6mm)	MPS	MPM3650

## EVB TEST RESULTS

Performance curves and waveforms are tested on the evaluation board,  $V_{IN} = 5V$ ,  $V_{OUT} = 1V$ ,  $T_A = 25^\circ C$ , unless otherwise noted.

**Thermal Derating**

$V_{OUT} = 1V$

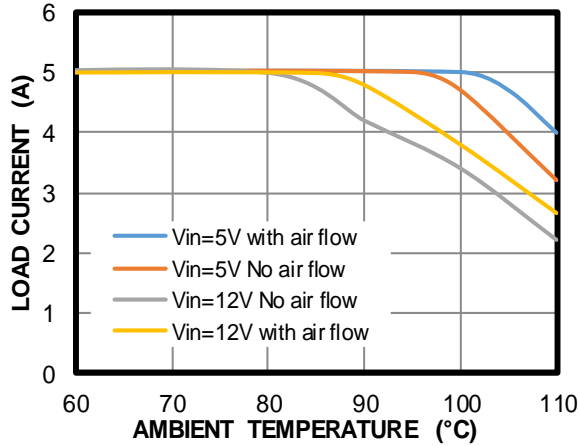

**Efficiency vs. Load Current**

$V_{OUT} = 1V$

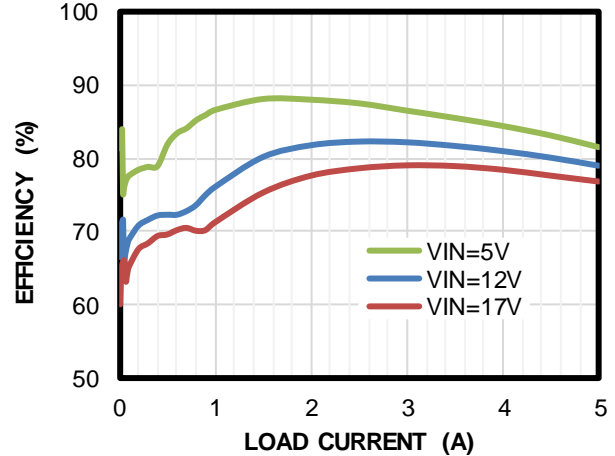

**Line Regulation**

$V_{OUT} = 1V$

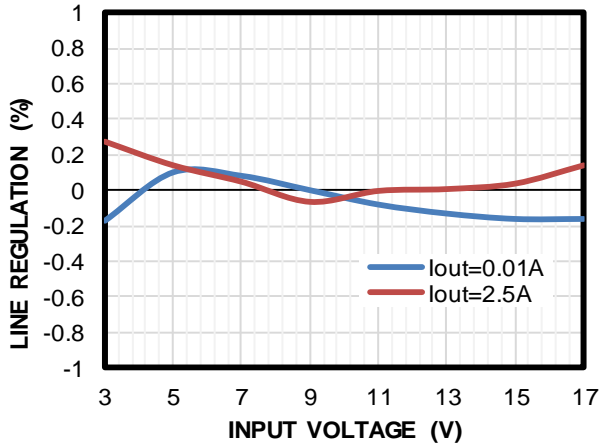

**Load Regulation**

$V_{OUT} = 1V$

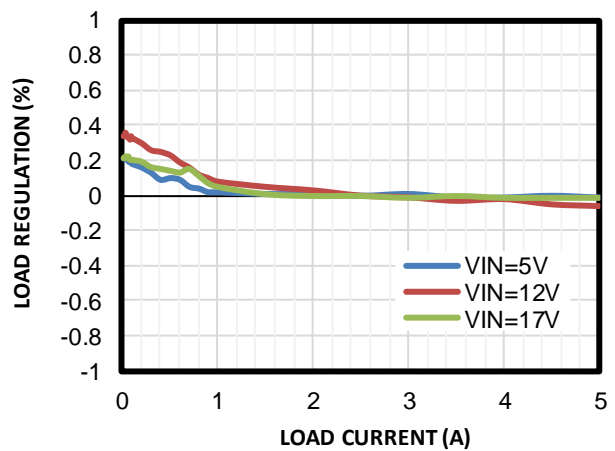

**Temperature vs. I<sub>OUT</sub>**

$V_{OUT} = 1V$ ,  $T_A = 15^\circ C$

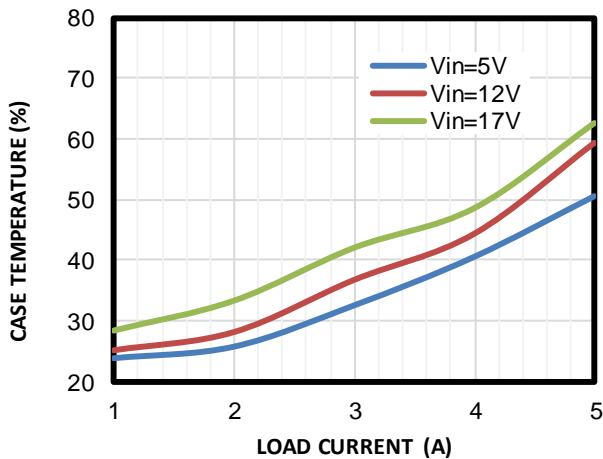

## EVB TEST RESULTS *(continued)*

Performance curves and waveforms are tested on the evaluation board,  $V_{IN} = 5V$ ,  $V_{OUT} = 1V$ ,  $T_A = 25^{\circ}C$ , unless otherwise noted.

**V<sub>OUT</sub> Ripple**  
 $I_{OUT} = 0A$

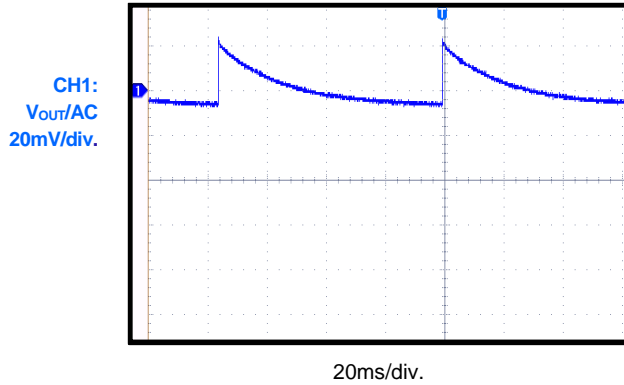

**V<sub>OUT</sub> Ripple**  
 $I_{OUT} = 5A$

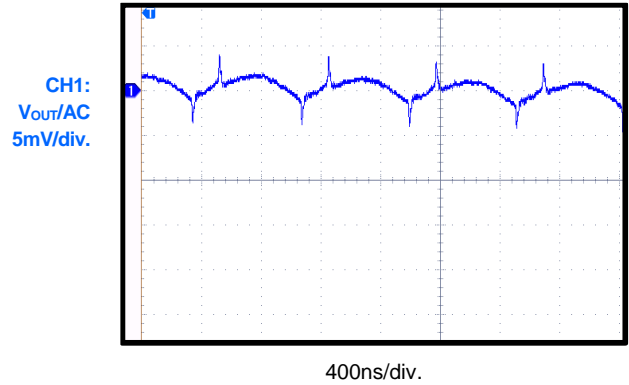

**Load Transient**  
 $I_{OUT} = 0A$  to  $2.5A$

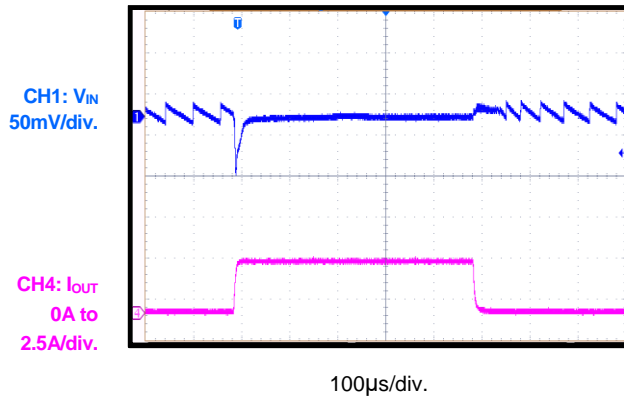

**Load Transient**  
 $I_{OUT} = 2.5A$  to  $5A$

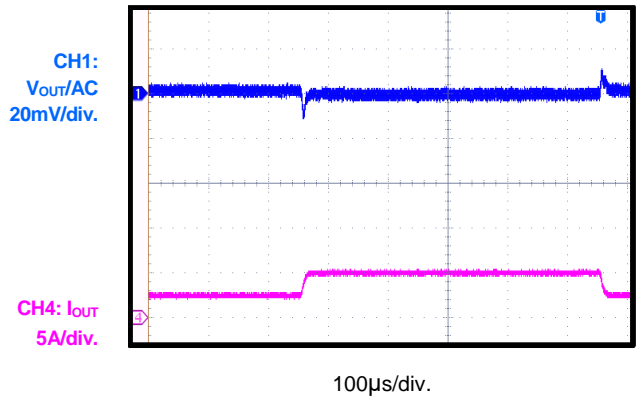

**V<sub>IN</sub> On**  
 $I_{OUT} = 0A$

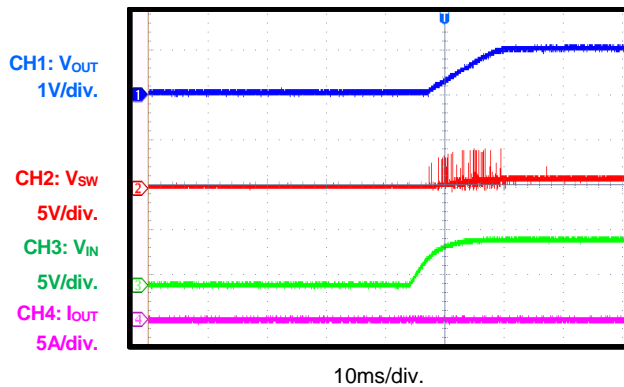

**V<sub>IN</sub> On**  
 $I_{OUT} = 5A$

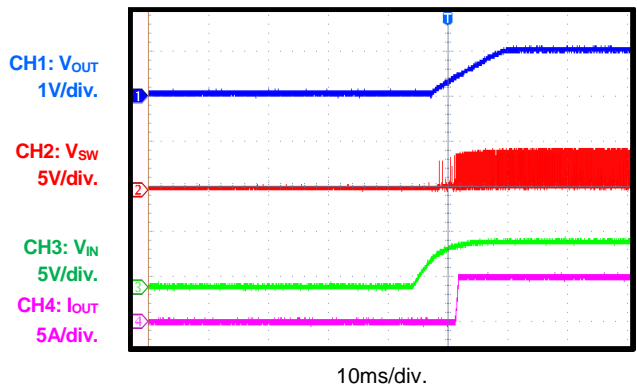

## EVB TEST RESULTS (continued)

Performance curves and waveforms are tested on the evaluation board,  $V_{IN} = 5V$ ,  $V_{OUT} = 1V$ ,  $T_A = 25^\circ C$ , unless otherwise noted.

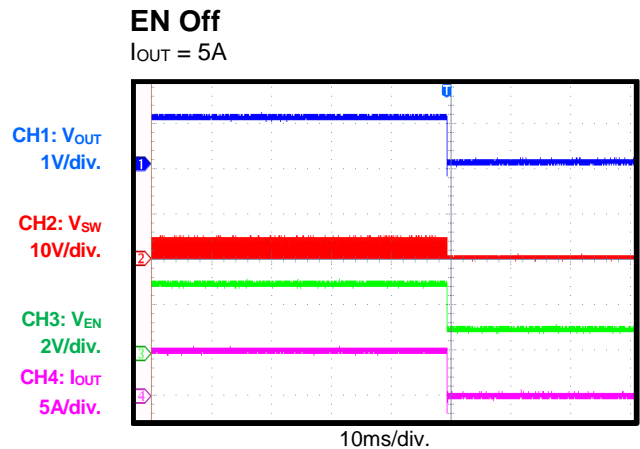
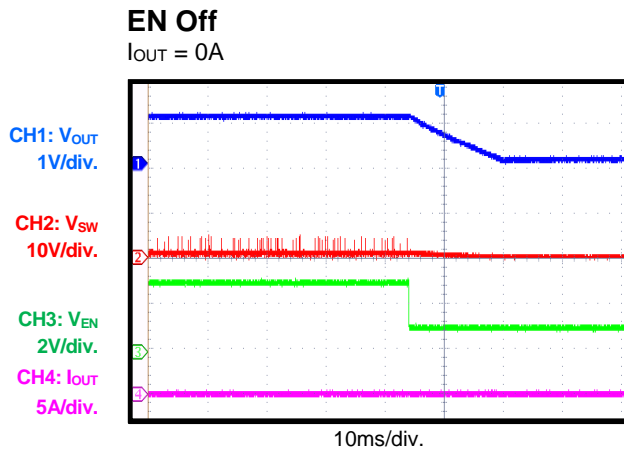
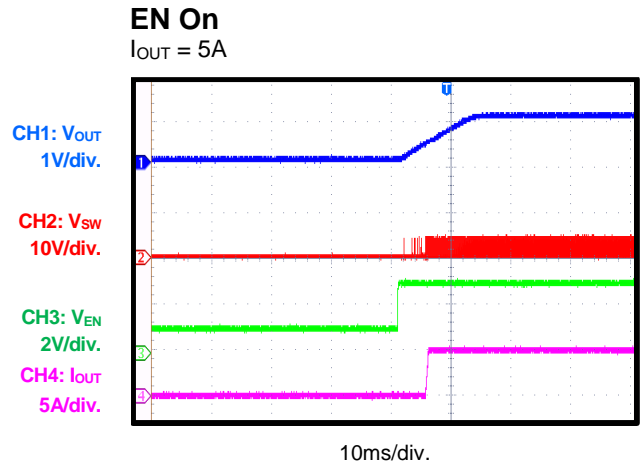
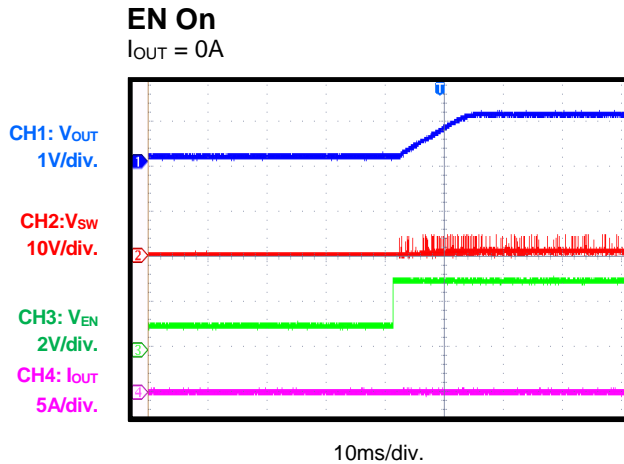
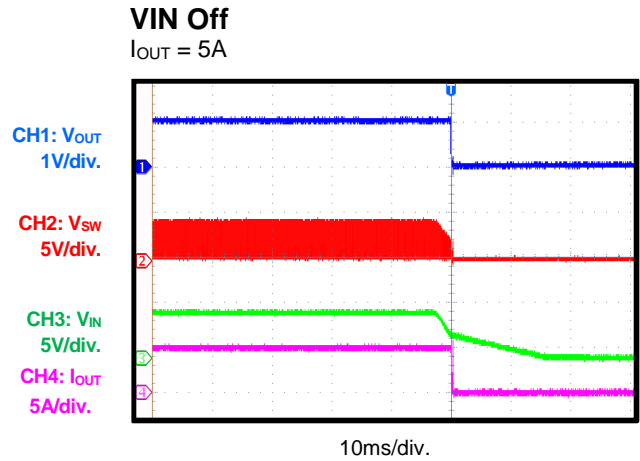
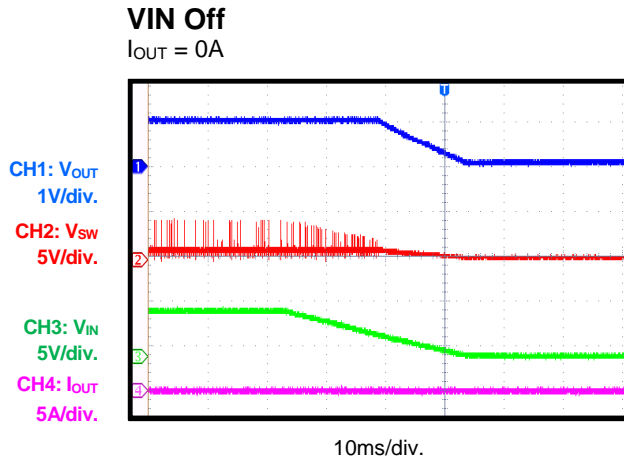

## EVB TEST RESULTS (continued)

Performance curves and waveforms are tested on the evaluation board,  $V_{IN} = 5V$ ,  $V_{OUT} = 1V$ ,  $T_A = 25^{\circ}C$ , unless otherwise noted.

SCP Steady State

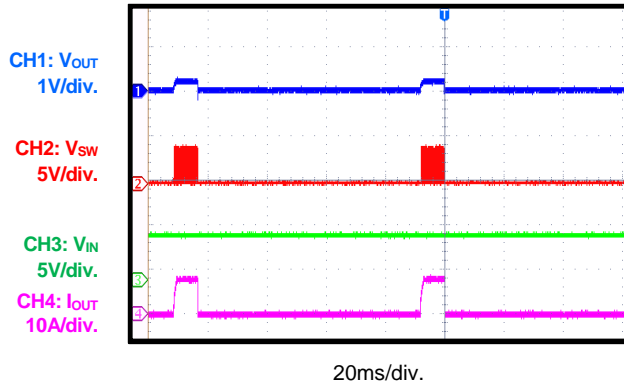

SCP Entry and Recovery

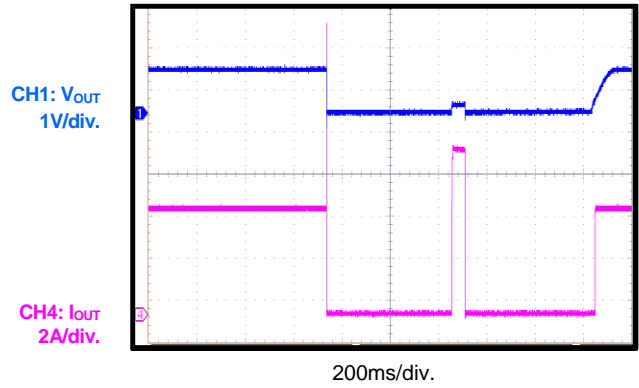

## PCB LAYOUT

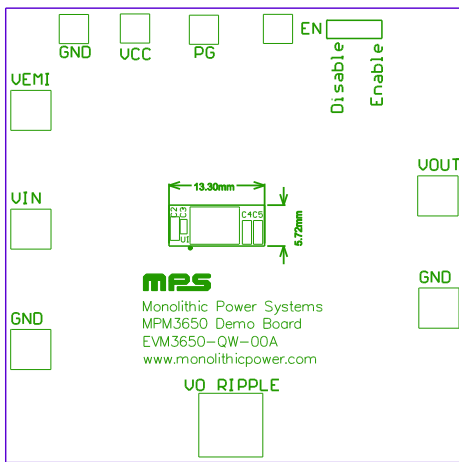

Figure 1: Top Silk Layer

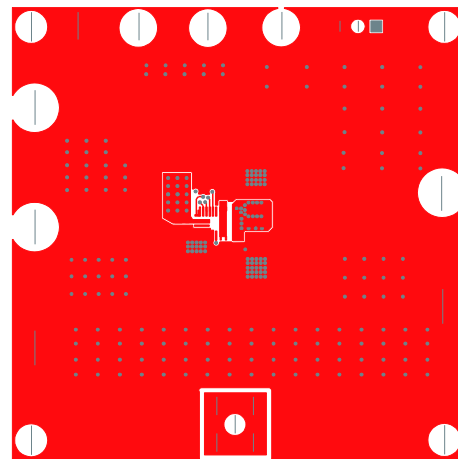

Figure 2: Top Layer

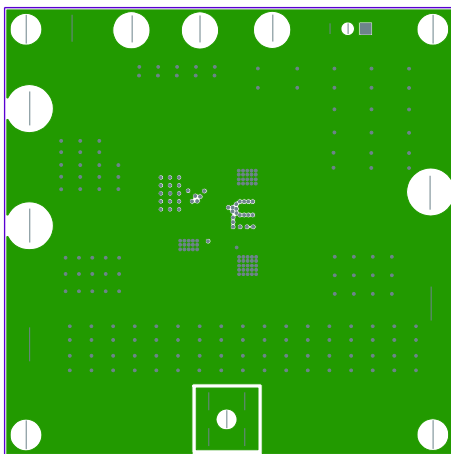

Figure 3: Mid-Layer 1

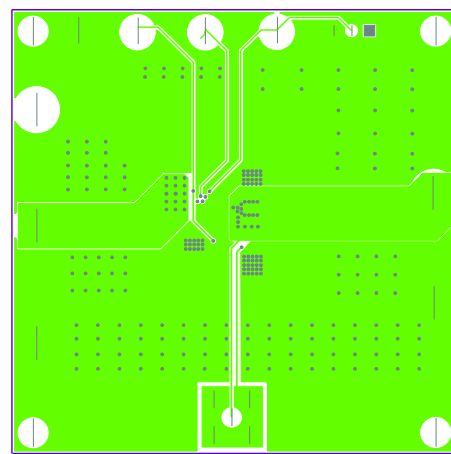
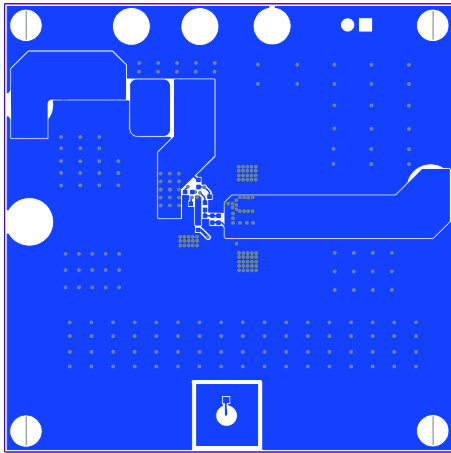
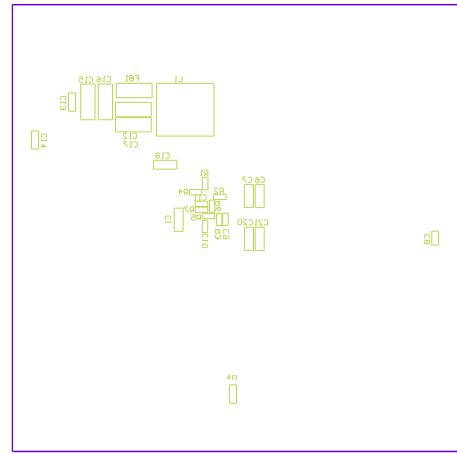

Figure 4: Mid-Layer 2



**Figure 5: Bottom Layer**



**Figure 6: Bottom Silk Layer**



## Revision History

Revision #	Revision Date	Description	Pages Updated
1.0	7/8/2020	Initial Release	-

**Notice:** The information in this document is subject to change without notice. Please contact MPS for current specifications. Users should warrant and guarantee that third-party Intellectual Property rights are not infringed upon when integrating MPS products into any application. MPS will not assume any legal responsibility for any said applications.