

## DESCRIPTION

The EVM3820-QV-00A is used for demonstrating the performance of MPS's MPM3820 a low voltage high switching frequency step-down switcher with built-in power MOSFETs and power inductor. MPM3820 provides up to 2A continuous highly efficient output with constant-on-time control for fast loop response.

High power efficiency over a wide load range is achieved by scaling down the switching frequency at light load to reduce the switching related loss by constant on time control. Short circuit and thermal shutdown provides reliable, fault-tolerant operation.

MPM3820 is available in QFN 3.0x5.0x1.6mm package.

## ELECTRICAL SPECIFICATION

Parameter	Symbol	Value	Units
Input Voltage	$V_{IN}$	2.7– 6	V
Output Voltage	$V_{OUT}$	1.2	V
Output Current	$I_{OUT}$	2	A

## FEATURES

- Wide 2.7V to 6V Operating Input Range
- Fixed and Adjustable Output from 0.6V
- 3.0mm x 5.0mm x 1.6mm QFN Package
- Total Solution Size 8.5mm x 4.5 mm
- Up to 2A Continuous Output Current
- 100% Duty Cycle in Dropout
- Ultra Low IQ: 40 $\mu$ A
- EN and Power Good for Power Sequencing
- Cycle-by-Cycle Over-Current Protection
- Short Circuit Protection with Hiccup Mode
- Adjustable Output Only Needs 4 External Components - 2 Ceramic Capacitors and FB Divider Resistors
- Fixed Output Only Needs Input and Output Capacitors

## APPLICATIONS

- Low Voltage I/O System Power
- LDO Replacement
- Power for Portable Products
- Storage (SSD/HDD)
- Space-limited Applications

All MPS parts are lead-free and adhere to the RoHS directive. For MPS green status, please visit MPS website under Quality Assurance. "MPS" and "The Future of Analog IC Technology", are Registered Trademarks of Monolithic Power Systems, Inc.

## EVM3820-QV-00A EVALUATION BOARD

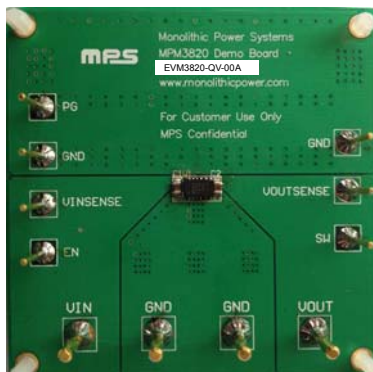

Board Number	MPS IC Number
EVM3820-QV-00A	MPM3820GQV

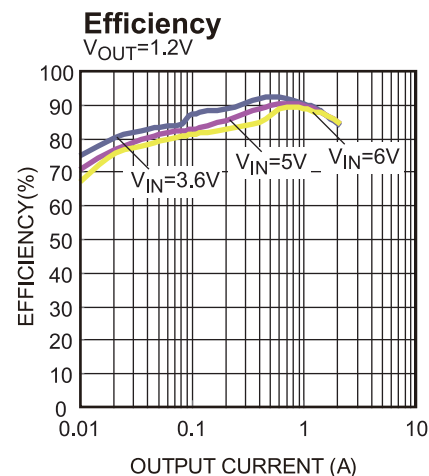

## EVALUATION BOARD SCHEMATIC

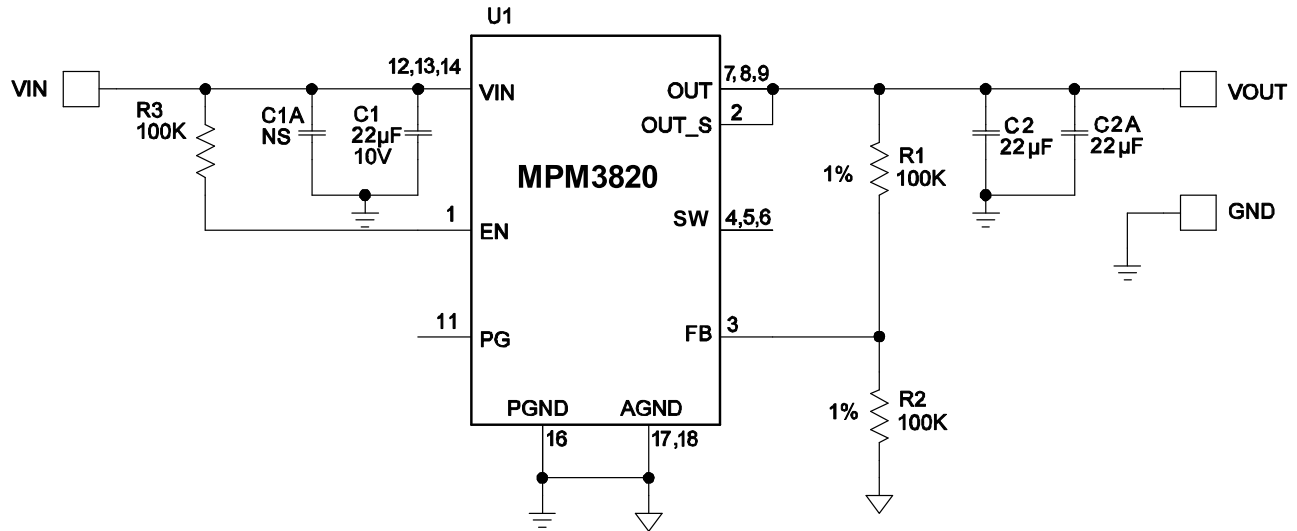

## EVM3820-QV-00A BILL OF MATERIALS

Qty	RefDes	Value	Description	Package	Manufacturer	Manufacturer P/N
3	C1, C2,C2A	22µF	Ceramic Cap., 10V, X5R	SM0805	TDK	C2012X5R1A226K
0	C1A	NS				
1	R1	100k	Film Res., 1%	SM0603	Any	
1	R2	100k	Film Res., 1%	SM0603	Any	
1	R3	100k	Film Res., 5%	SM0603	Yageo	RC0603FR-07100KL
1	U1		COT Buck	QFN 3.0*5.0	MPS	MPM3820GQV

## EVB TEST RESULTS

Performance waveforms are tested on the evaluation board.

$V_{IN}=5V$ ,  $V_{OUT}=1.2V$ ,  $T_A = 25^{\circ}C$ , unless otherwise noted.

**Quiescent Current vs. Input Voltage**

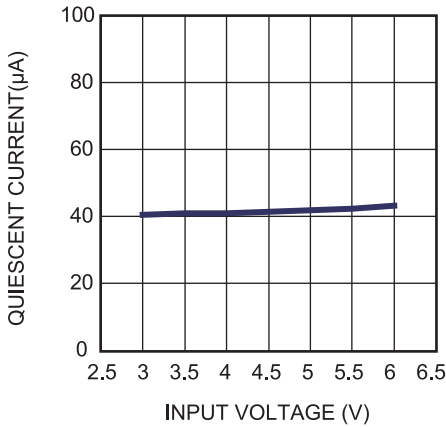

**Shutdown Current vs. Input Voltage**

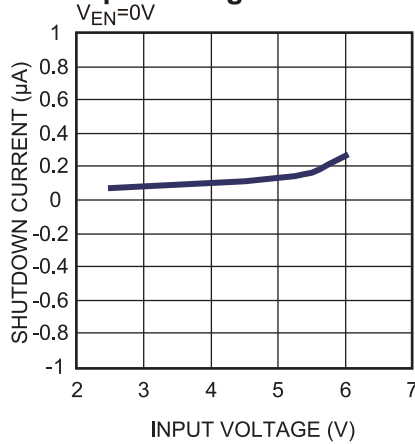

**Load Regulation vs. Output Current**

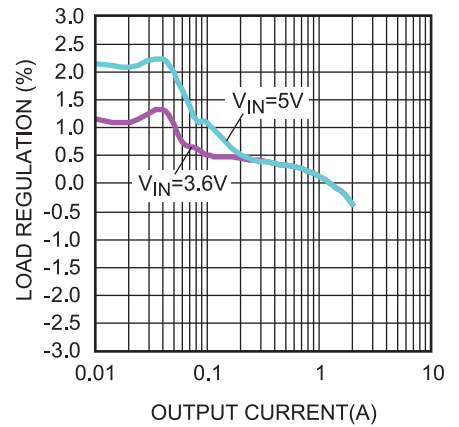

**Line Regulation vs. Input Voltage**

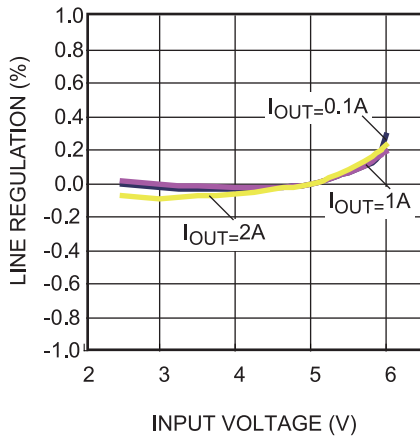

**Case Temperature Rise**

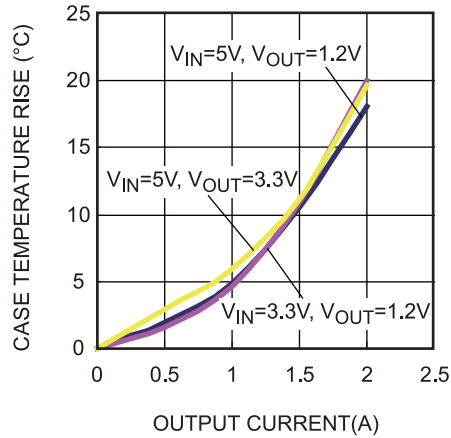

**Efficiency**

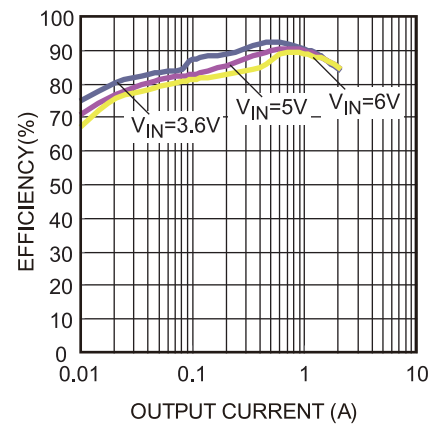

## EVB TEST RESULTS *(continued)*

Performance waveforms are tested on the evaluation board.

$V_{IN}=5V$ ,  $V_{OUT}=1.2V$ ,  $T_A = 25^{\circ}C$ , unless otherwise noted.

**Input and Output Ripple**  
 $I_{OUT}=0A$

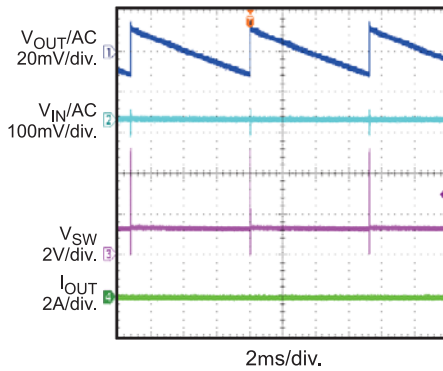

**Input and Output Ripple**  
 $I_{OUT}=1A$

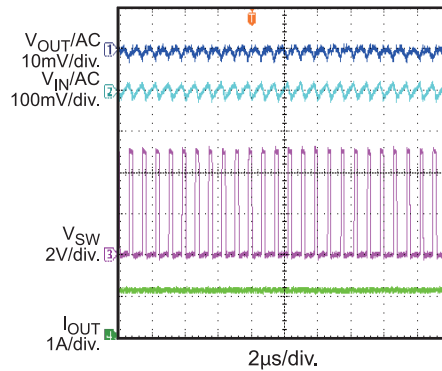

**Input and Output Ripple**  
 $I_{OUT}=2A$

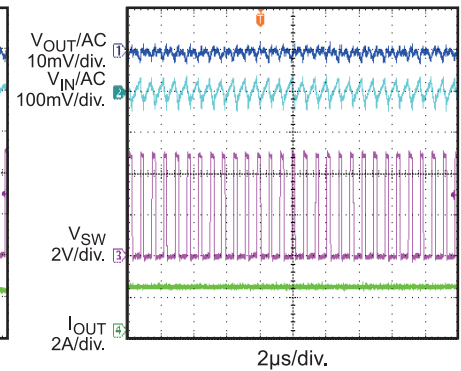

**$V_{IN}$  Power Up without Load**

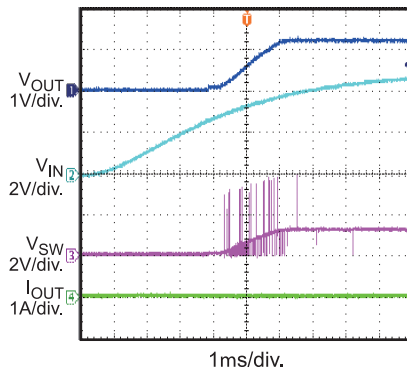

**$V_{IN}$  Power Up with 2A Load**

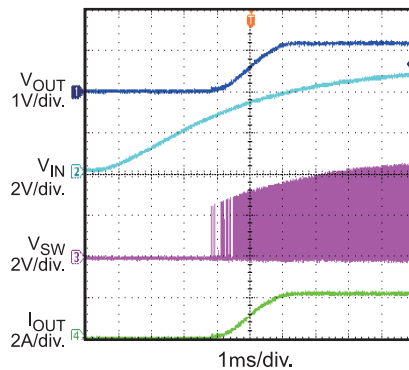

**$V_{IN}$  Shut down without Load**

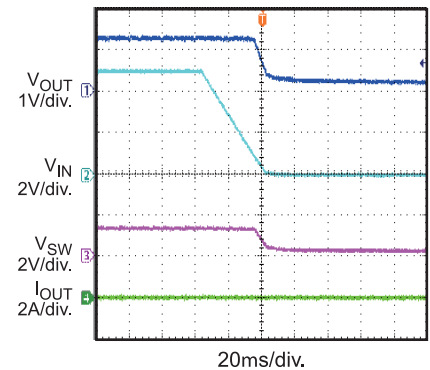

**$V_{IN}$  Shut down with 2A Load**

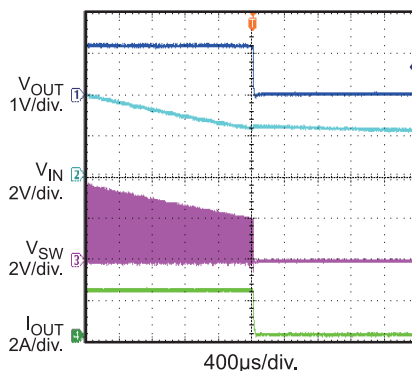

**EN Start Up without Load**

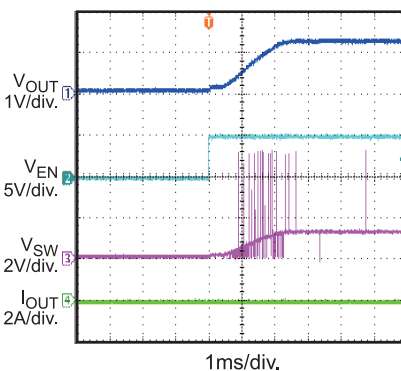

**EN Shut Down without Load**

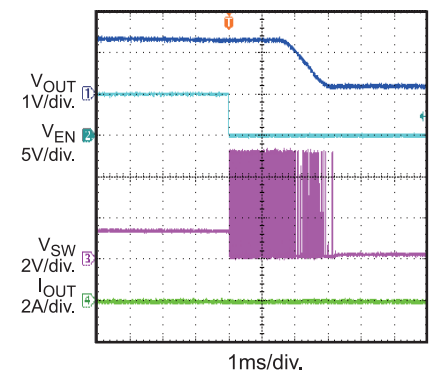

### EVB TEST RESULTS *(continued)*

Performance waveforms are tested on the evaluation board.

$V_{IN}=5V$ ,  $V_{OUT}=1.2V$ ,  $T_A = 25^{\circ}C$ , unless otherwise noted.

**EN Start Up  
with 2A Load**

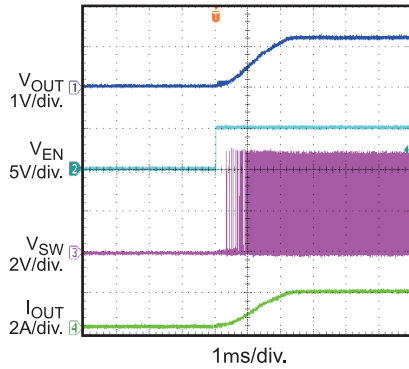

**EN Shut Down  
with 2A Load**

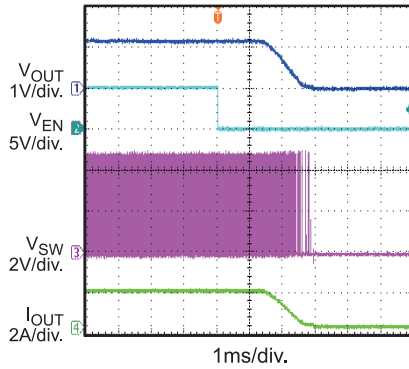

**Power Good  
Through EN Start Up**

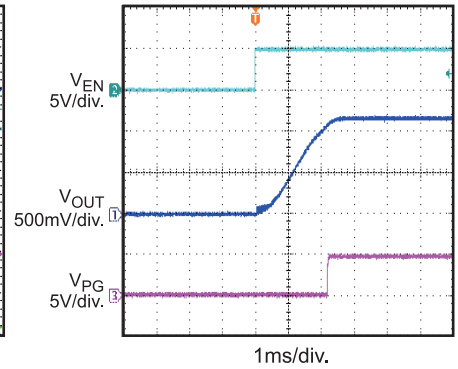

**V<sub>IN</sub> Power Up  
without Load**

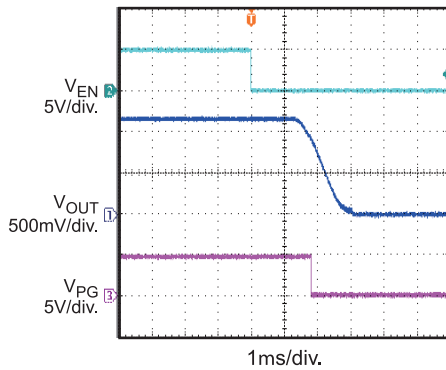

**Load Transient Response**

$I_{OUT}=1A$  to  $2A$

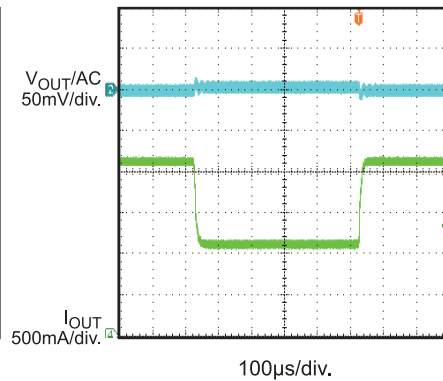

**Short Circuit Entry**

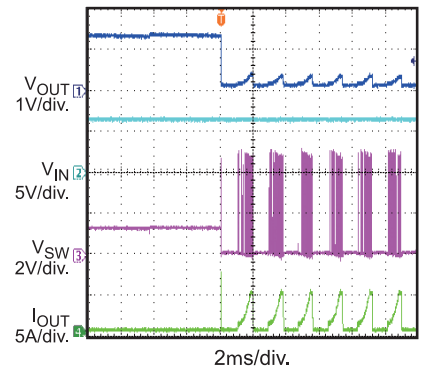

**Short Circuit**

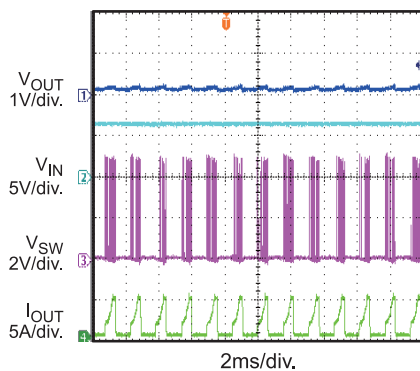

**Short Circuit Recovery**

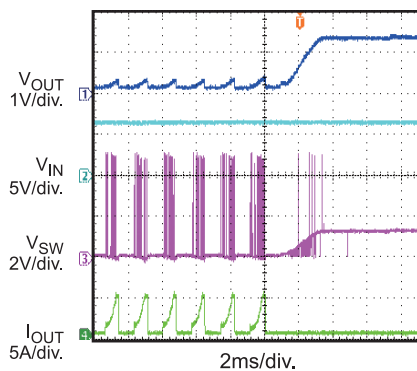

### PRINTED CIRCUIT BOARD LAYER

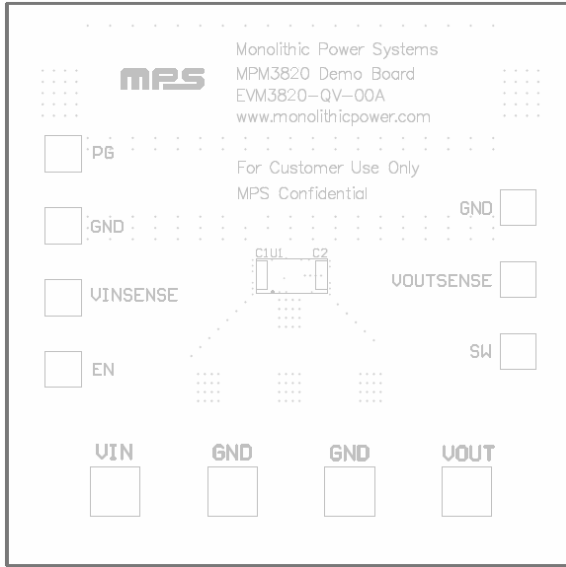

Figure 1: Top Silk Layer

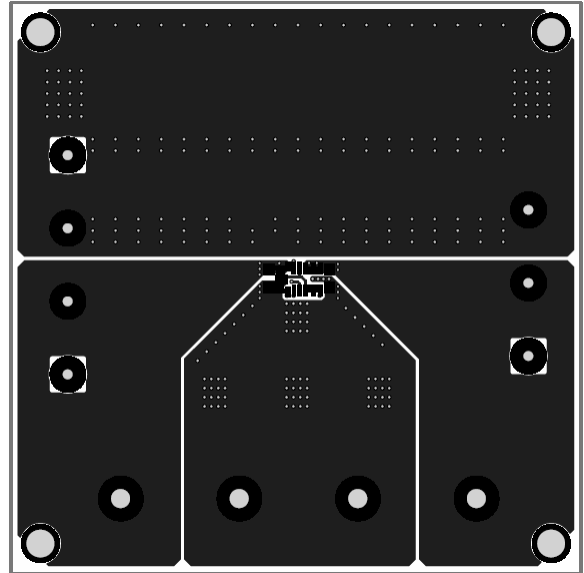

Figure 2: Top Layer

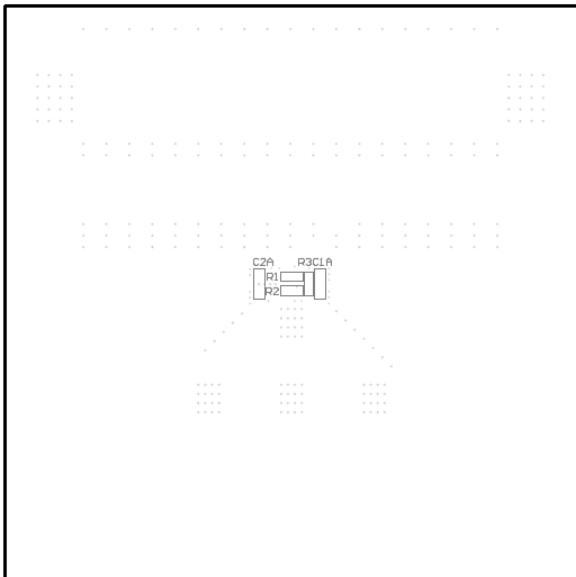

Figure 3: Bottom Silk Layer

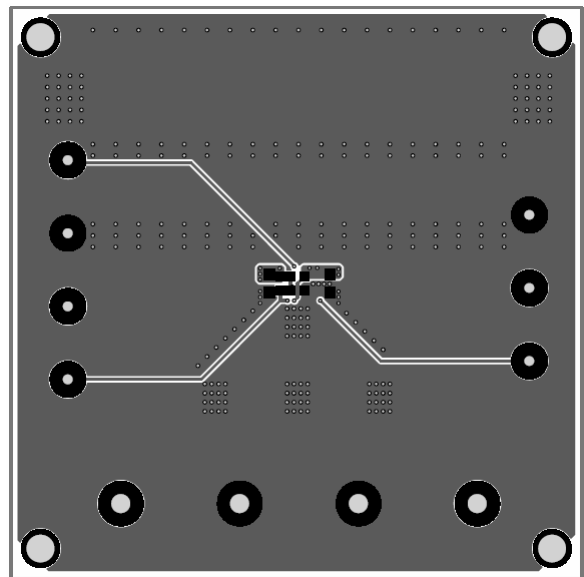

Figure 4: Bottom Layer

## QUICK START GUIDE (ADJUSTABLE OUTPUT)

The output voltage of this board is set externally which can be regulated as low as 0.6V by operating from +2.7V to +6V input as the figure 5. The default output voltage of this board is set to 1.2V.

1. Connect the positive and negative terminals of the load to the VOUT and GND pins, respectively.
2. Preset the power supply output between 2.7V and 6V, and then turn off the power supply.
3. Connect the positive and negative terminals of the power supply output to the VIN and GND pins, respectively.
4. Turn the power supply on. The board will automatically start up.
5. The Output Voltage  $V_{OUT}$  can be changed by varying R2. Choose R1 to be around 50kΩ to 200kΩ. R2 is then given by:

$$R2 = \frac{R1}{\frac{V_{out}}{0.6} - 1}$$

Example: For  $V_{out} = 1V$ ,  $R1 = 100k\Omega$ ,  $R2 = 150k\Omega$ .

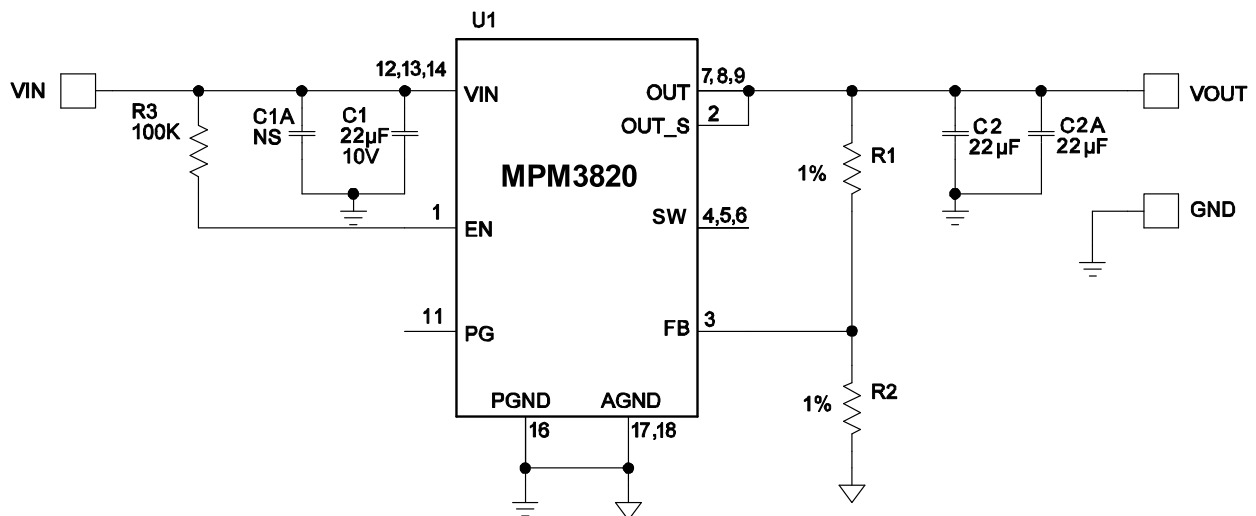

**Figure 5—Adjustable Version**

## LAYOUT RECOMMENDATION OF MPM3820

Proper layout of the switching power supplies is very important, and sometimes critical to make it work properly. Especially, for the high switching converter, if the layout is not carefully done, the regulator could show poor line or load regulation, stability issues.

**NOTICE:** The information in this document is subject to change without notice. Please contact MPS for current specifications. Users should warrant and guarantee that third party Intellectual Property rights are not infringed upon when integrating MPS products into any application. MPS will not assume any legal responsibility for any said applications.