



EVQ2242-D-00A

2A, 6V, Configurable-Frequency, Synchronous Buck Converter Evaluation Board, AEC-Q100 Qualified

DESCRIPTION

The EVQ2242-D-00A is an evaluation board designed to demonstrate the capabilities of the MPQ2242, a configurable-frequency (300kHz to 2.2MHz), synchronous step-down converter with an integrated high-side MOSFET (HS-FET) and a synchronous rectifier to provide high efficiency without an external Schottky diode.

The MPQ2242 can achieve up to 2A of continuous output current (I_{OUT}) across a 2.7V to 6V input voltage (V_{IN}) range, with an output voltage (V_{OUT}) down to 0.606V. It is ideal for a wide range of applications, including automotive infotainment systems, clusters, and telematics, as well as portable instruments.

Advanced asynchronous modulation (AAM) mode provides high efficiency by reducing switching losses at light loads, while forced continuous

conduction mode (FCCM) has a controllable switching frequency (f_{SW}) and a lower V_{OUT} ripple. Peak current control mode provides excellent transient response and high efficiency.

An open-drain power good (PG) signal indicates whether the V_{OUT} is within 85% to 115% of the nominal voltage.

Full protection features include over-current protection (OCP) with valley current detection to avoid current runaway, short-circuit protection (SCP), over-voltage protection (OVP), and thermal shutdown with automatic recovery.

The EVQ2242-D-00A is fully assembled and tested. The MPQ2242 is available in a QFN-9 (2mmx3mm) package, and is available in AEC-Q100 Grade 1.

PERFORMANCE SUMMARY

Specifications are at $T_A = 25^\circ\text{C}$, unless otherwise noted.

Parameters	Conditions	Value
Input voltage (V_{IN}) range		2.7V to 6V
Output voltage (V_{OUT})	$V_{IN} = 2.7\text{V to }6\text{V}, I_{OUT} = 0\text{A to }2\text{A}$	1.8V
Maximum output current (I_{OUT})	$V_{IN} = 2.7\text{V to }6\text{V}$	2A
Typical efficiency	$V_{IN} = 5\text{V}, V_{OUT} = 1.8\text{V}, I_{OUT} = 2\text{A}$	92.1%
Peak efficiency	$V_{IN} = 2.7\text{V}, V_{OUT} = 1.8\text{V}, I_{OUT} = 0.6\text{A}$	95.1%
Switching frequency (f_{SW})		2.1MHz

EVQ2242-D-00A EVALUATION BOARD

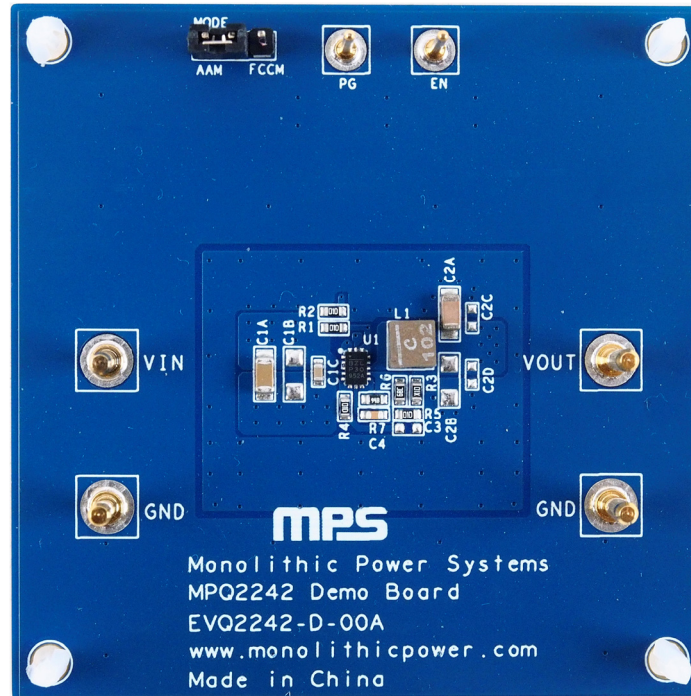

LxWxH (6.35cmx6.35cmx0.85cm)

Board Number	MPS IC Number
EVQ2242-D-00A	MPQ2242GDE-AEC1

QUICK START GUIDE

The EVQ2242-D-00A evaluation board is easy to set up and use to evaluate the MPQ2242's performance. For proper measurement equipment set-up, refer to Figure 2 on page 4 and follow the steps below:

1. Preset the power supply between 2.7V and 6V, then turn off the power supply.
2. Set the load current between 0A and 2A. Electronic loads represent a negative impedance to the converter. Setting a current too high may trigger over-current protection (OCP) (e.g. if the inductor current reaches the peak current limit, OCP is triggered).
3. If longer cables are used between the source and the evaluation board (>0.5m total), place a damping capacitor at the input terminals.
4. Connect the power supply terminals to:
 - a. Positive (+): VIN
 - b. Negative (-): GND
5. Connect the load terminals to:
 - a. Positive (+): VOUT
 - b. Negative (-): GND
6. After making the connections, turn on the power supply.
7. To use the enable (EN) function, apply a digital input to the EN pin. Pull EN above 1.2V to turn the converter on; pull EN below 0.4V to turn it off. If the EN function is not used, connect the EN pin directly to VIN.
8. The external resistor divider sets the output voltage (V_{OUT}) (see Figure 1).

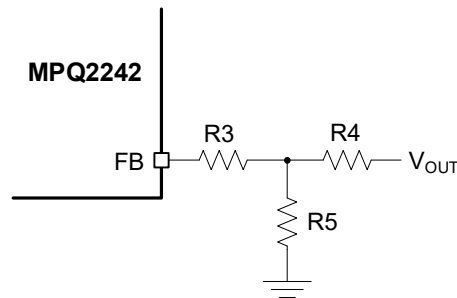

Figure 1: Feedback Divider Network with Adjustable Output

Choose R3 and R4 to be 100kΩ. R5 can be calculated using Equation (1):

$$R5 = \frac{R4}{\frac{V_{OUT}}{0.606V} - 1} \quad (1)$$

Refer to the Application Information section in the MPQ2242 datasheet to calculate the inductance and output capacitance for different V_{OUT} values.

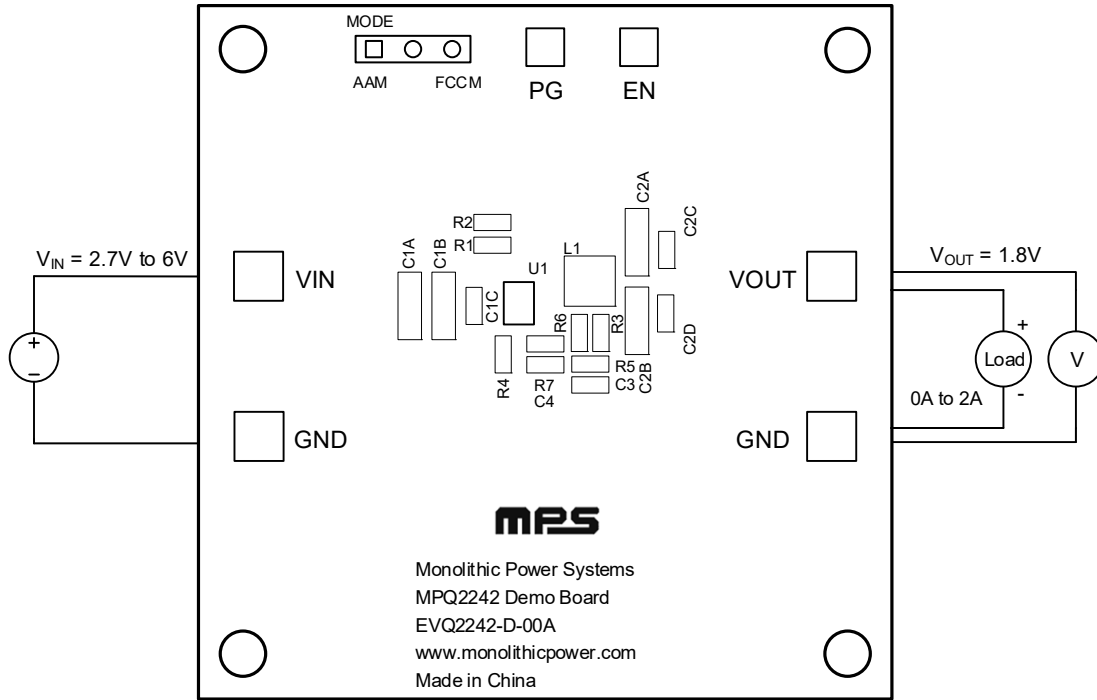

Figure 2: Measurement Equipment Set-Up

EVALUATION BOARD SCHEMATIC

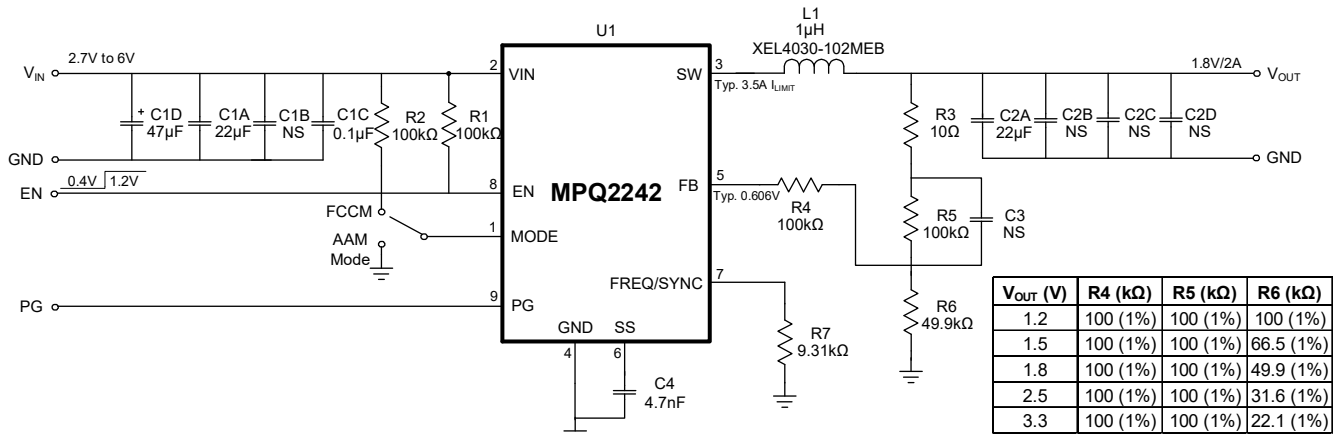
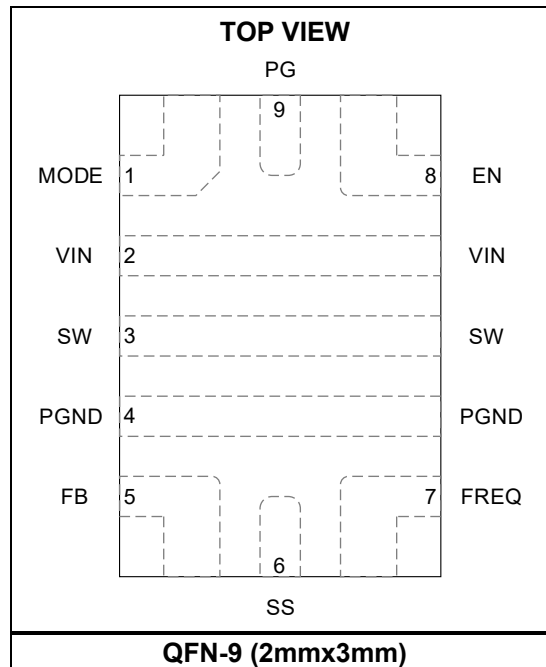

Figure 3: Evaluation Board Schematic

PACKAGE REFERENCE



EVQ2242-D-00A BILL OF MATERIALS

Qty	Ref	Value	Description	Package	Manufacturer	Manufacturer PN
1	C4	4.7nF	Ceramic capacitor, 50V, X7R	0603	Wurth	885012206087
1	C1A	22 μ F	Ceramic capacitor, 16V, X5R	1206	Murata	GRM31CR61C226 ME15L
1	C1C	0.1 μ F	Ceramic capacitor, 16V, X7R	0603	Murata	GRM188R71C104 KA01D
1	C1D	47 μ F	Electrolytic capacitor, 16V	SMD	Jianghai	VZ2-16V47
1	C2A	22 μ F	Ceramic capacitor, 10V, X7R	1206	Murata	GCJ31CR71A226 ME01L
5	C3, C1B, C2B, C2C, C2D	NS				
1	L1	1 μ H	Inductor, 8.9m Ω , 9A	SMD	Coilcraft	XEL4030-102MEB
4	R1, R2, R4, R5	100k Ω	Film resistor, 1%	0603	Yageo	RC0603FR-07100KL
1	R3	10 Ω	Film resistor, 1%	0603	Yageo	RC0603FR-0710RL
1	R6	49.9k Ω	Film resistor, 1%	0603	Yageo	RC0603FR-0749K9L
1	R7	9.31k Ω	Film resistor, 1%	0603	Yageo	RC0603FR-079K31L
4	VIN, GND, GND, VOUT	2mm	Golden pin	DIP	Custom ⁽¹⁾	
2	PG, EN	1mm	Golden pin	DIP	Custom ⁽¹⁾	
1	MODE	2.54mm	Test pin, 3-pin	DIP	Custom ⁽¹⁾	
1	U1	MPQ2242	2A, 6V, synchronous buck converter, AEC-Q100	QFN-9	MPS	MPQ2242GDE-AEC1

Note:

1) Contact an MPS FAE for more information regarding custom pins.

EVB TEST RESULTS

Performance curves and waveforms are tested on the evaluation board. $V_{IN} = 5V$, $V_{OUT} = 1.8V$, $T_A = 25^\circ C$, unless otherwise noted.

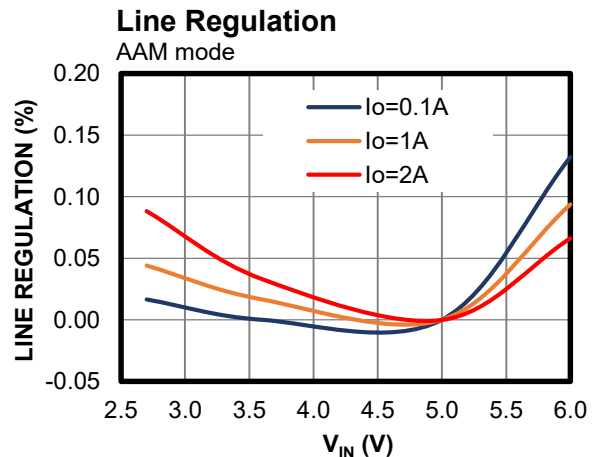
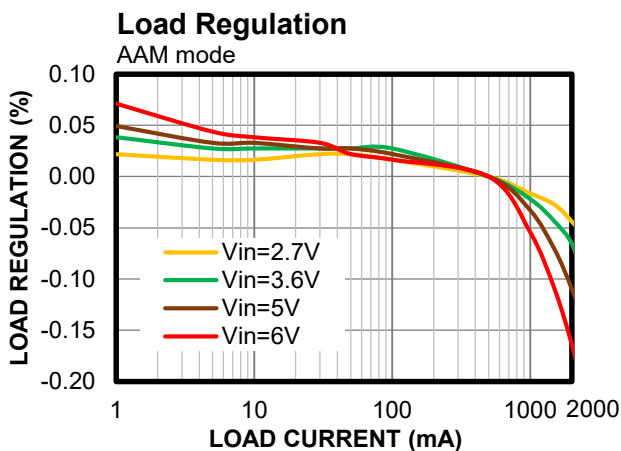
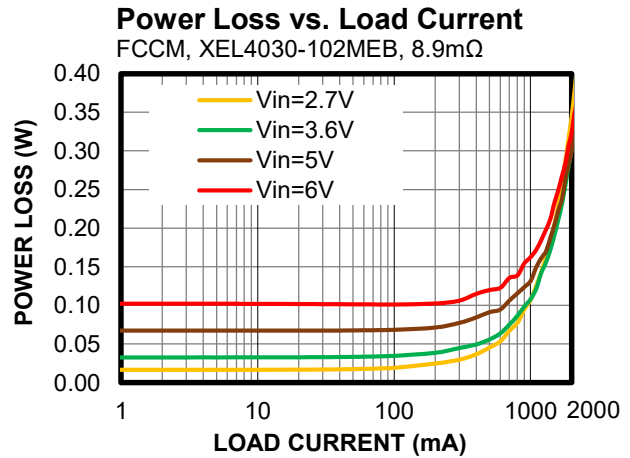
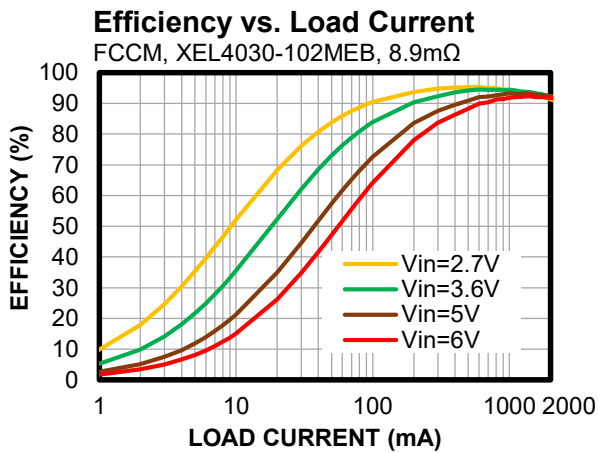
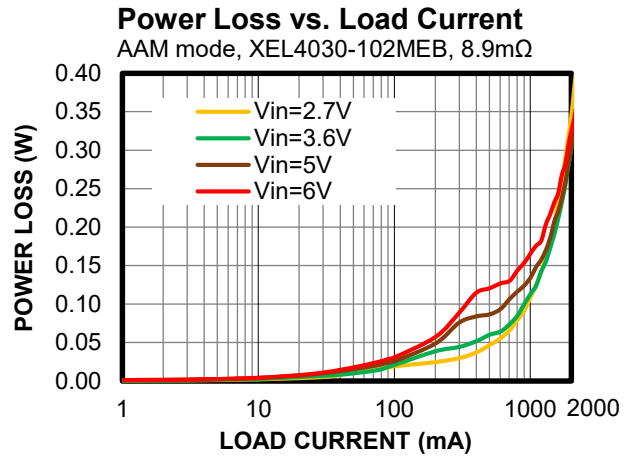
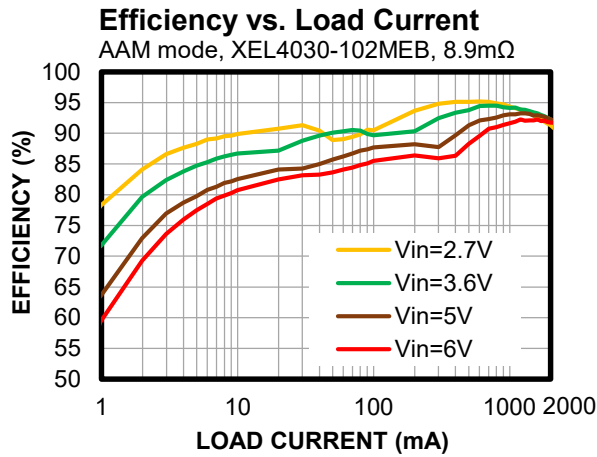

EVB TEST RESULTS *(continued)*

Performance curves and waveforms are tested on the evaluation board. $V_{IN} = 5V$, $V_{OUT} = 1.8V$, $T_A = 25^\circ C$, unless otherwise noted.

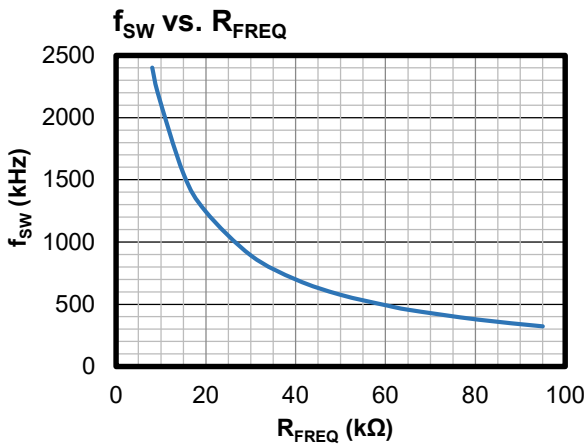
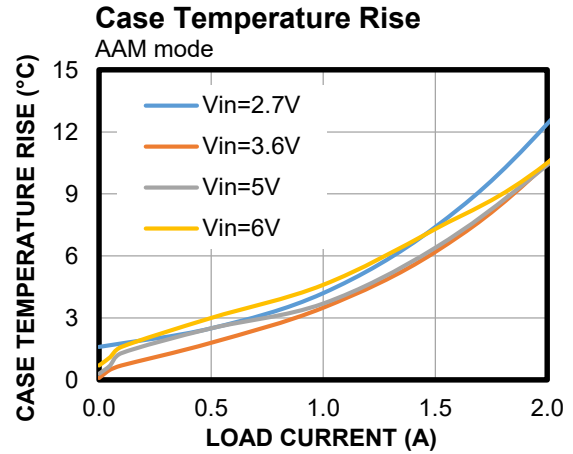
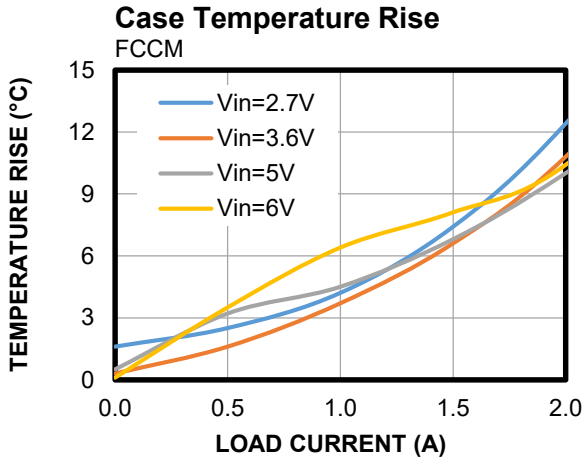

EVB TEST RESULTS *(continued)*

Performance curves and waveforms are tested on the evaluation board. $V_{IN} = 5V$, $V_{OUT} = 1.8V$, $T_A = 25^\circ C$, unless otherwise noted.

Thermal Performance

$I_{OUT} = 1A$, no forced airflow, $T_{CASE} = 29.1^\circ C$

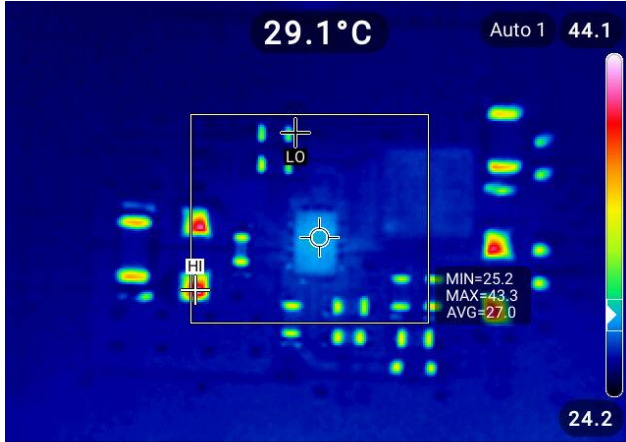

Thermal Performance

$I_{OUT} = 2A$, no forced airflow, $T_{CASE} = 34.8^\circ C$

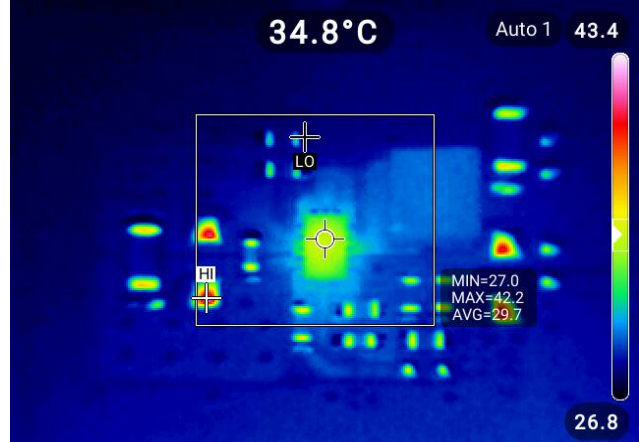

EVB TEST RESULTS (continued)

Performance curves and waveforms are tested on the evaluation board. $V_{IN} = 5V$, $V_{OUT} = 1.8V$, $T_A = 25^\circ C$, unless otherwise noted.

Steady State

$I_{OUT} = 0A$, AAM mode

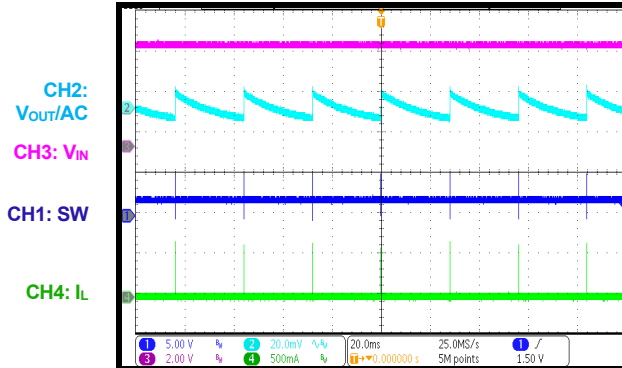

Steady State

$I_{OUT} = 0A$, FCCM

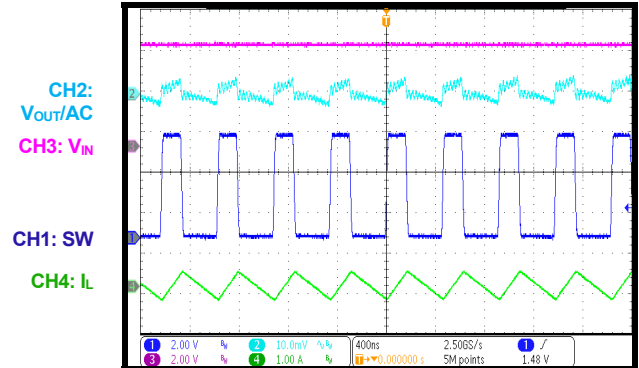

Steady State

$I_{OUT} = 2A$

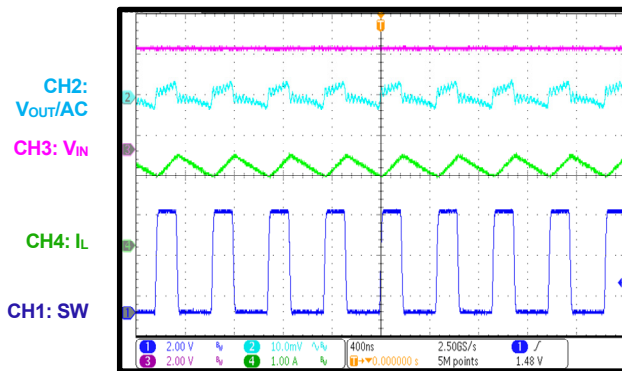

Start-Up through VIN

$I_{OUT} = 0A$, AAM mode

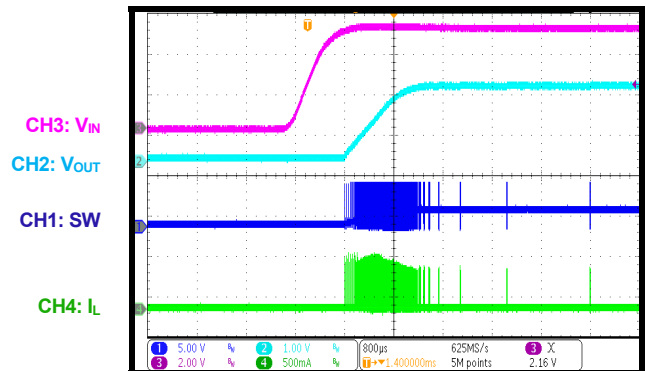

Start-Up through VIN

$I_{OUT} = 0A$, FCCM

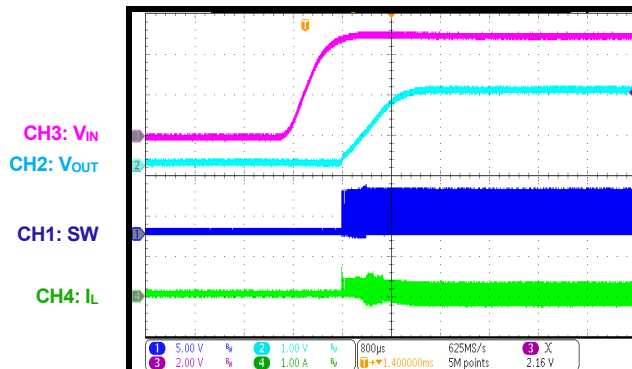

Start-Up through VIN

$I_{OUT} = 2A$

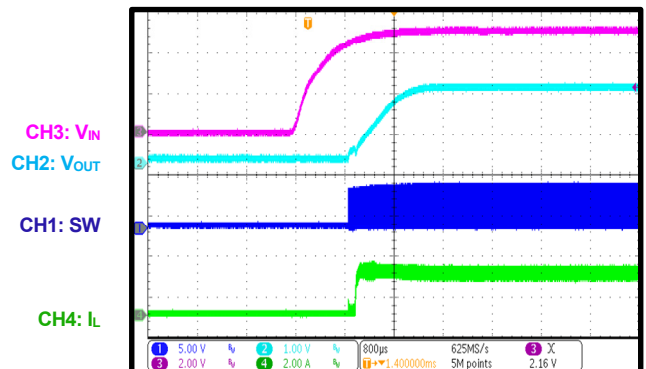

EVB TEST RESULTS (continued)

Performance curves and waveforms are tested on the evaluation board. $V_{IN} = 5V$, $V_{OUT} = 1.8V$, $T_A = 25^\circ C$, unless otherwise noted.

Shutdown through VIN

$I_{OUT} = 0A$, AAM mode

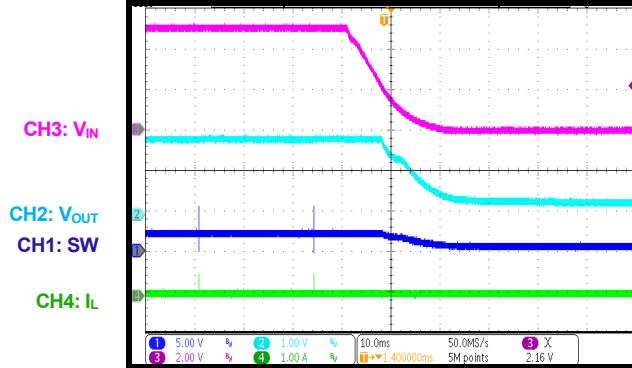

Shutdown through VIN

$I_{OUT} = 0A$, FCCM

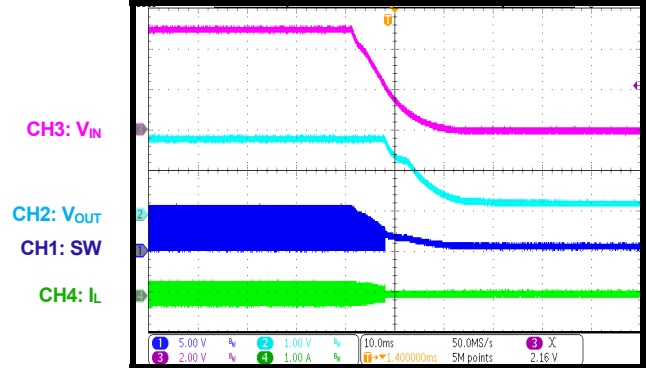

Shutdown through VIN

$I_{OUT} = 2A$

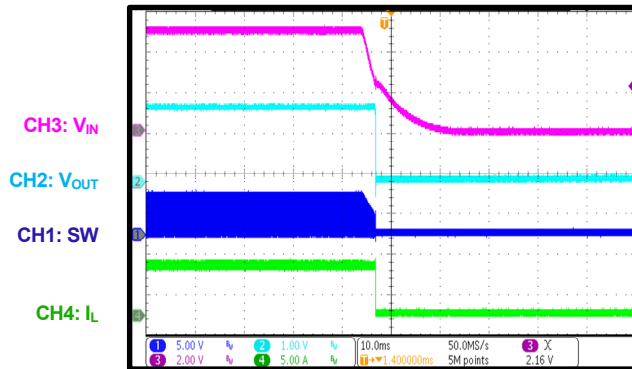

Start-Up through EN

$I_{OUT} = 0A$, AAM mode

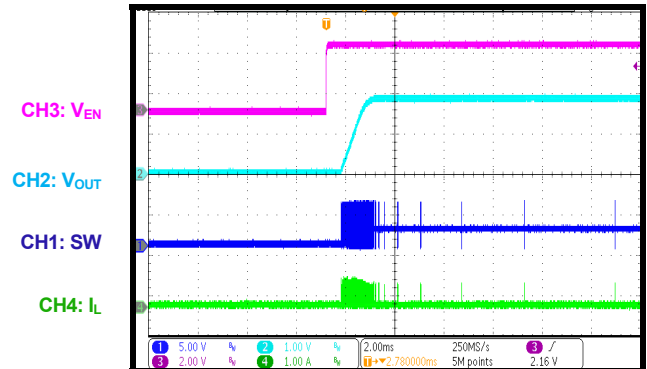

Start-Up through EN

$I_{OUT} = 0A$, FCCM

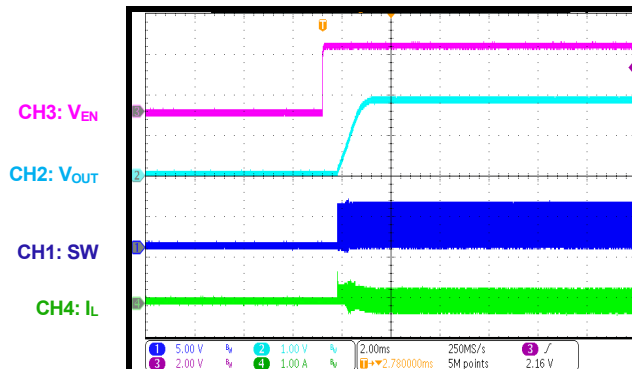

Start-Up through EN

$I_{OUT} = 2A$

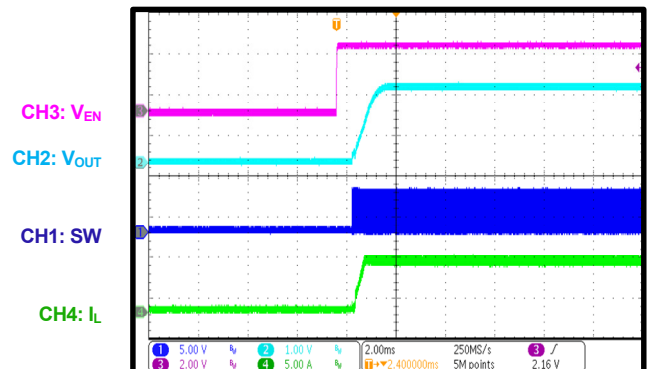

EVB TEST RESULTS (continued)

Performance curves and waveforms are tested on the evaluation board. $V_{IN} = 5V$, $V_{OUT} = 1.8V$, $T_A = 25^\circ C$, unless otherwise noted.

Shutdown through EN

$I_{OUT} = 0A$, AAM mode

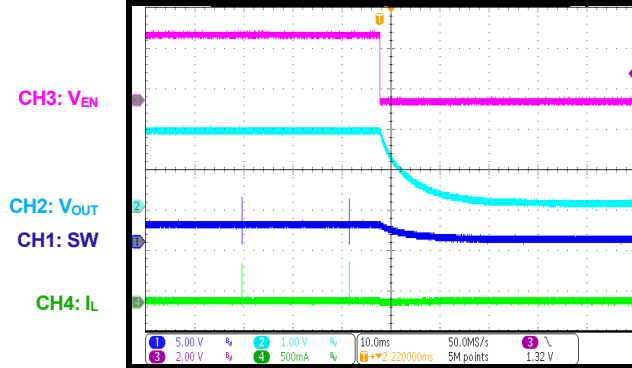

Shutdown through EN

$I_{OUT} = 0A$, FCCM

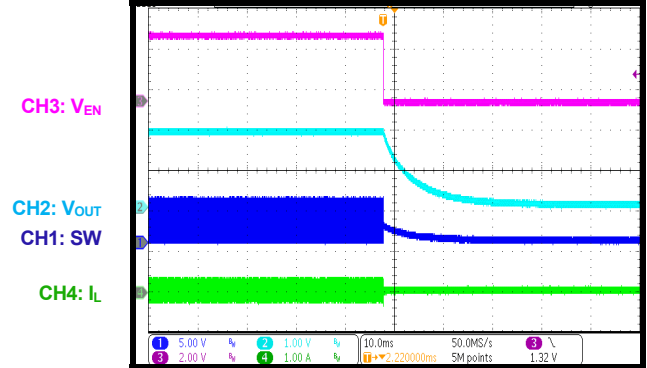

Shutdown through EN

$I_{OUT} = 2A$

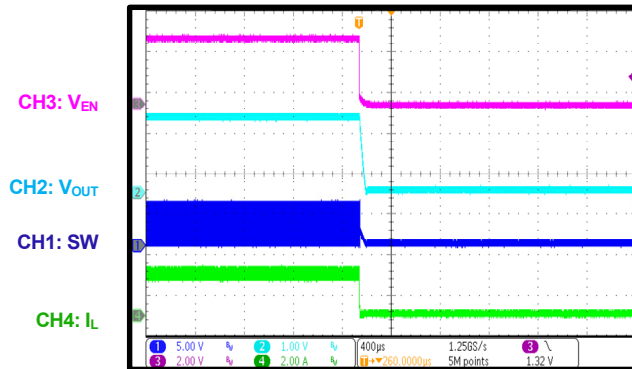

SCP Entry

$I_{OUT} = 0A$, AAM mode

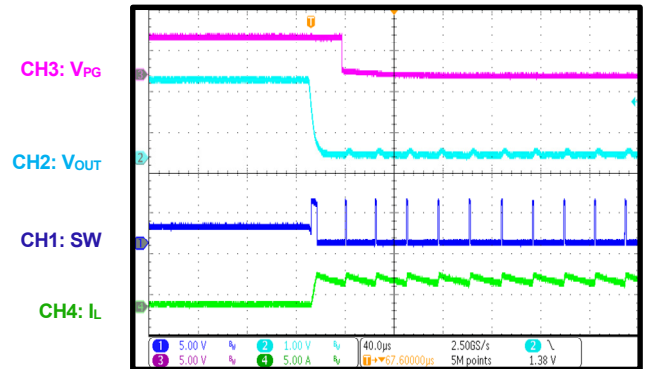

SCP Entry

$I_{OUT} = 0A$, FCCM

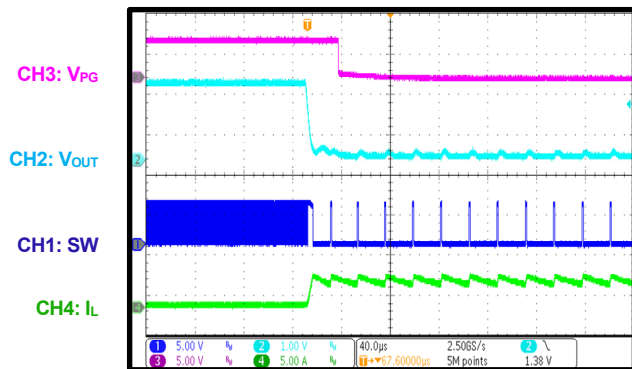

SCP Entry

$I_{OUT} = 2A$

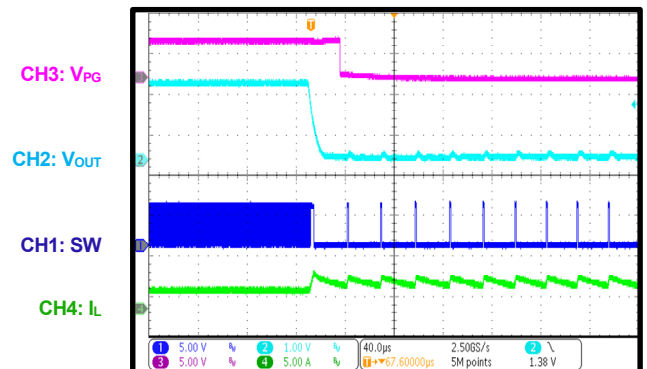

EVB TEST RESULTS (continued)

Performance curves and waveforms are tested on the evaluation board. $V_{IN} = 5V$, $V_{OUT} = 1.8V$, $T_A = 25^\circ C$, unless otherwise noted.

SCP Recovery
 $I_{OUT} = 0A$, AAM mode

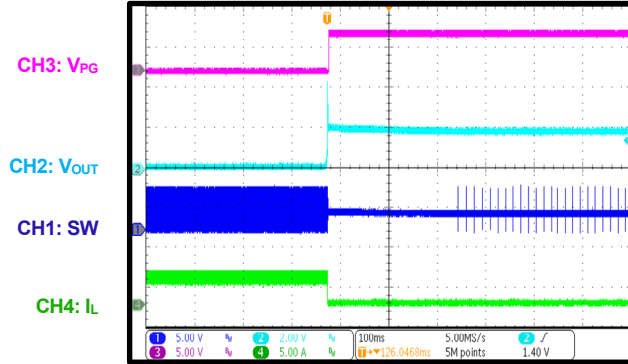

SCP Recovery
 $I_{OUT} = 0A$, FCCM

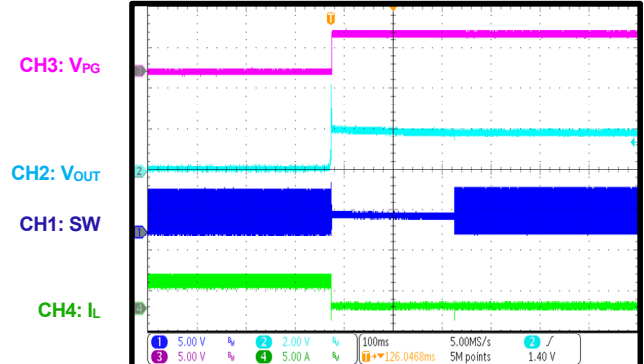

SCP Recovery
 $I_{OUT} = 2A$

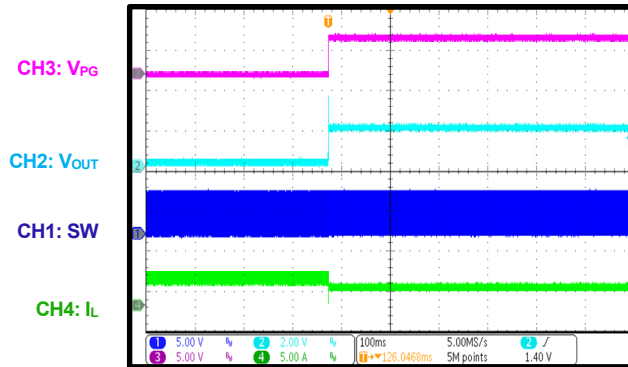

Short-Circuit Protection

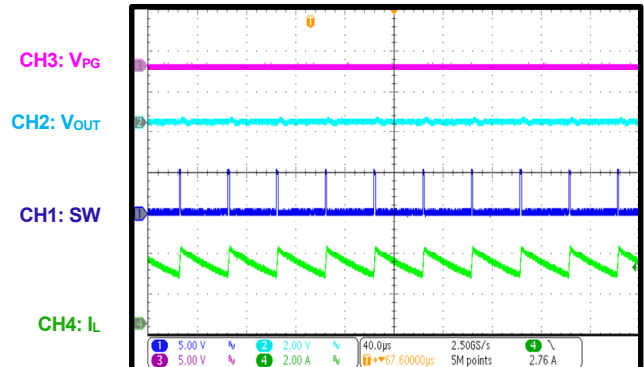

PG Start-Up through VIN
 $I_{OUT} = 0A$, FCCM

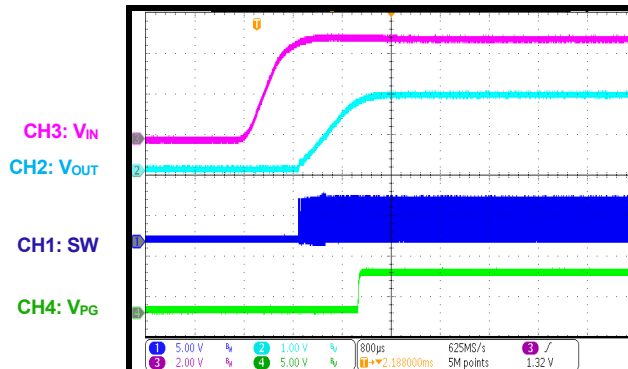

PG Shutdown through VIN
 $I_{OUT} = 0A$, FCCM

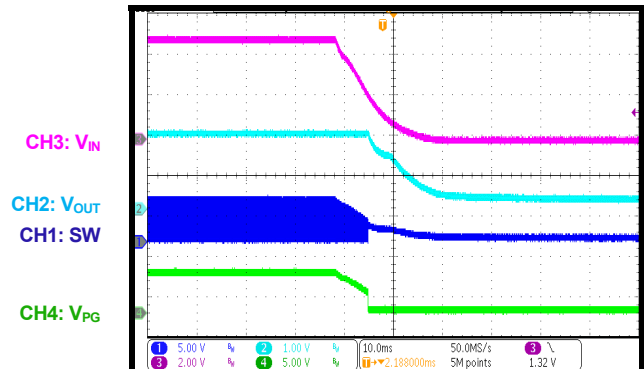

EVB TEST RESULTS (continued)

Performance curves and waveforms are tested on the evaluation board. $V_{IN} = 5V$, $V_{OUT} = 1.8V$, $T_A = 25^\circ C$, unless otherwise noted.

PG Start-Up through EN

$I_{OUT} = 0A$, FCCM

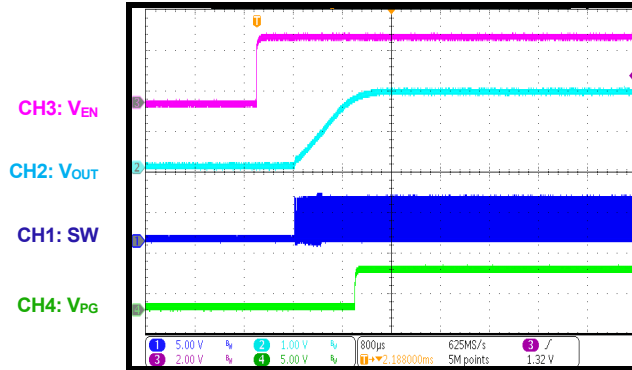

PG Shutdown through EN

$I_{OUT} = 0A$, FCCM

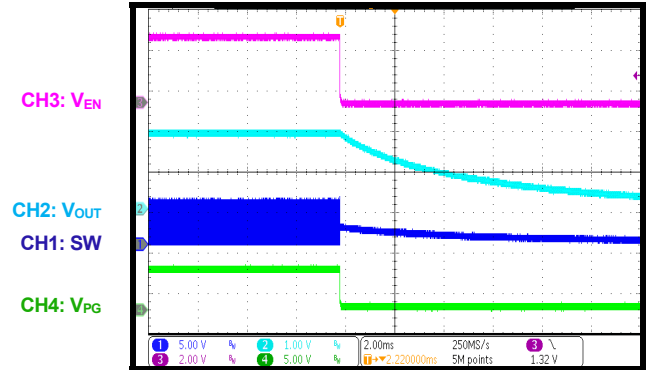

Load Transient

$I_{OUT} = 0A$ to $2A$, slew rate = $1.6A/\mu s$,
AAM mode

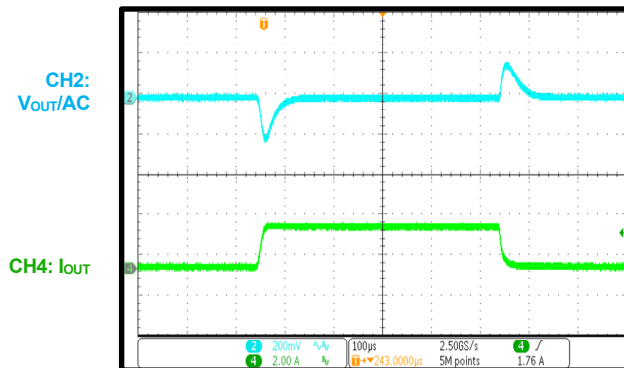

PCB LAYOUT (2)

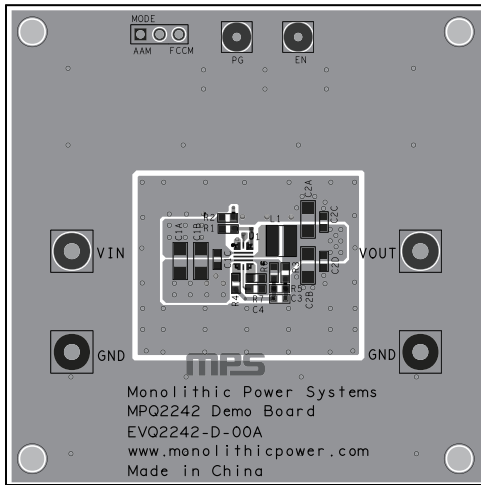

Figure 4: Top Silk and Top Layer

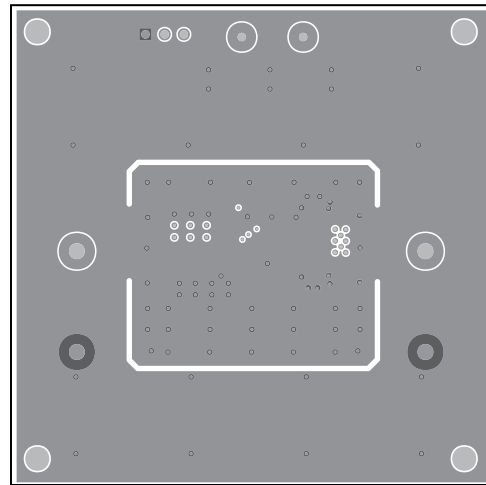

Figure 5: Mid-Layer 1

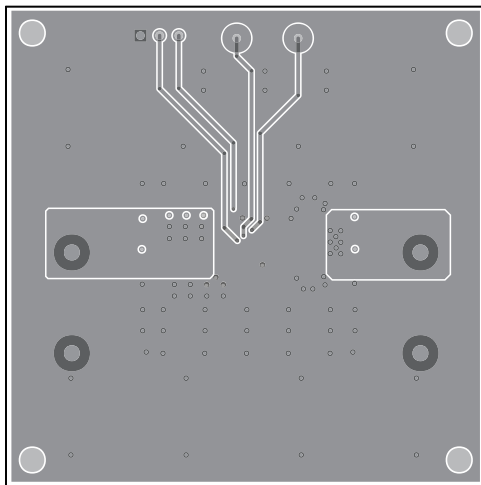

Figure 6: Mid-Layer 2

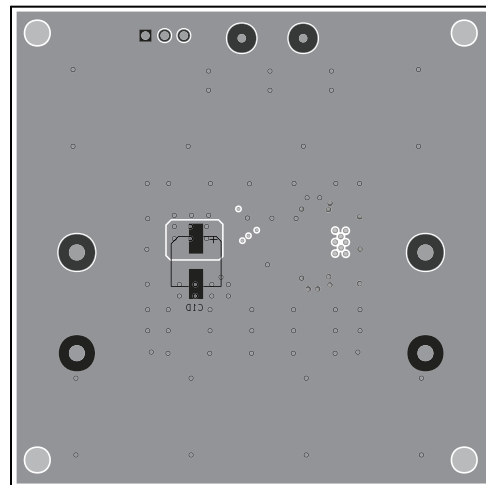

Figure 7: Bottom Layer and Bottom Silk

Note:

2) The copper thickness is 2oz.

REVISION HISTORY

Revision #	Revision Date	Description	Pages Updated
1.0	2/23/2023	Initial Release	-

Notice: The information in this document is subject to change without notice. Please contact MPS for current specifications. Users should warrant and guarantee that third-party Intellectual Property rights are not infringed upon when integrating MPS products into any application. MPS will not assume any legal responsibility for any said applications.