

DESCRIPTION

The EVQ2451-G-00A is an evaluation board for the MPQ2451, a fixed 2MHz frequency step-down switching regulator with an integrated internal high-side high voltage power MOSFET. The IC provides 0.3A output with current mode control for fast loop response and easy compensation.

High power conversion efficiency over a wide load range is achieved by scaling down the switching frequency at light load condition to reduce the switching and gate driving losses.

The soft-start function helps prevent inductor current runaway during startup and thermal shutdown provides reliable, fault tolerant operation.

By switching at 2MHz, smaller value inductor and input/output capacitor can be used to lower down cost and save board space.

ELECTRICAL SPECIFICATIONS

Parameter	Symbol	Value	Units
Input Voltage	V_{IN}	8-36	V
Output Voltage	V_{OUT}	5	V
Output Current	I_{OUT}	0-0.3	A

FEATURES

- Wide Operating Input Range
- Fixed 2MHz Switching Frequency
- 0.3A Output Current
- Up to 90% Efficiency

APPLICATIONS

- High Voltage Power Conversion
- Automotive Systems
- Industrial Power Systems
- Distributed Power Systems
- Battery Powered Systems

All MPS parts are lead-free and adhere to the RoHS directive. For MPS green status, please visit MPS website under Products, Quality Assurance page. "MPS" and "The Future of Analog IC Technology" are Registered Trademarks of Monolithic Power Systems, Inc.

EVQ2451-G-01A EVALUATION BOARD



(L x W x H) 1.8" x 1.8" x 0.4"
4.6cm x 4.6cm x 1.0cm

Board Number	MPS IC Number
EVQ2451-G-01A	MPQ2451-G

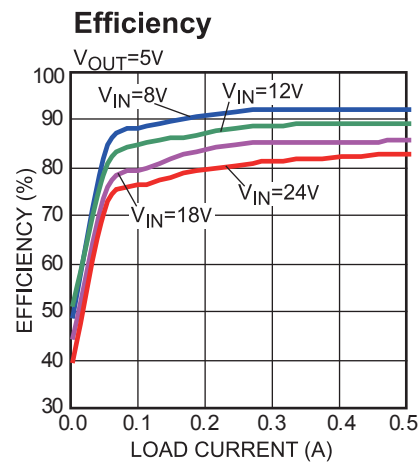

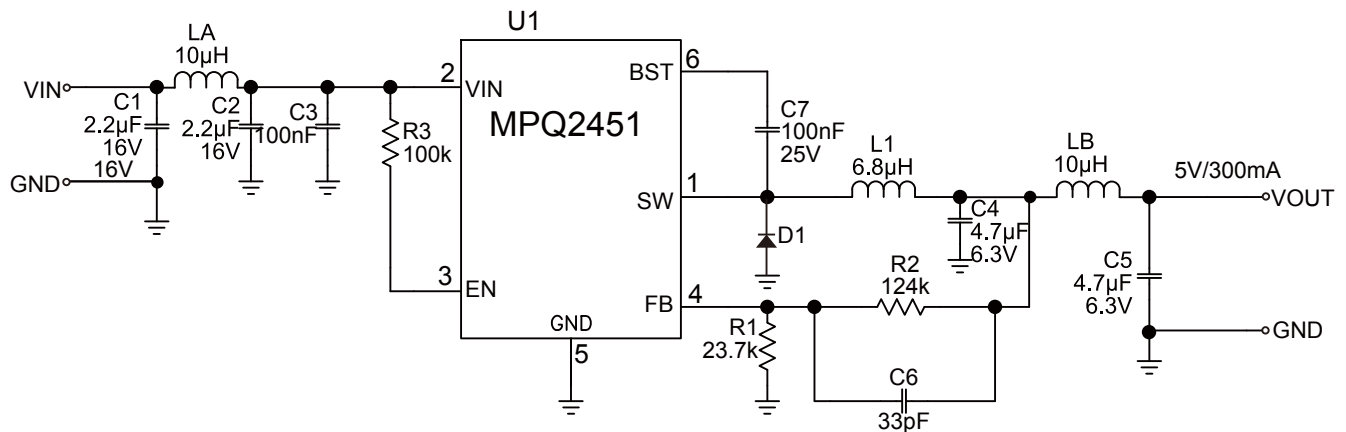
EVALUATION BOARD SCHEMATIC

EVQ2451-G-01A BILL OF MATERIALS

Qty	Ref	Value	Description	Package	Manufacturer	Manufacturer P/N
2	C1,C2	2.2µF	Ceramic Cap., 16V, 10%, X5R	0603	muRata	GRM188R61C225KE15D
2	C3,C7	0.1µF	Ceramic Cap., 25V, 10%, X5R	0402	muRata	GRM155R61E104KA87D
2	C4,C5	4.7µF	Ceramic Cap., 6.3V, 10%, X5R	0603	muRata	GRM188R60J475KE19D
	C6	33pF	Ceramic Cap., 50V, 10%, NP0	0402	muRata	GRM1555C1H330JZ01D
1	D1	40V/0.38A	Schottky Diode., 40V, 0.38A	SOD523	ZEETEX	ZLLS350TA
1	L1	6.8µH	Inductor, Idc=1A, Rdc=216mΩ	3x3mm	TDK	VLS3015E-6R8M
2	LA, LB	10µH	Inductor, Idc=0.5A	2x2x1.2mm	TDK	VLS2012ET-100M
1	R1	23.7kΩ	Film Res., 1%	0402	Panasonic	ERJ-2RK2372X
1	R2	124kΩ	Film Res., 1%	0402	Yageo	RC0402FR-07124KL
1	R3	100kΩ	Film Res., 1%	0402	Yageo	RC0402JR-07100KL
4	U1	MPQ2451DG	Power Led Driver	QFN6L-2X2mm	MPS	MPQ2451DG-R3
1	VIN, GND, VOUT, GND		Test Point		HZ	China market

EVB TEST RESULTS

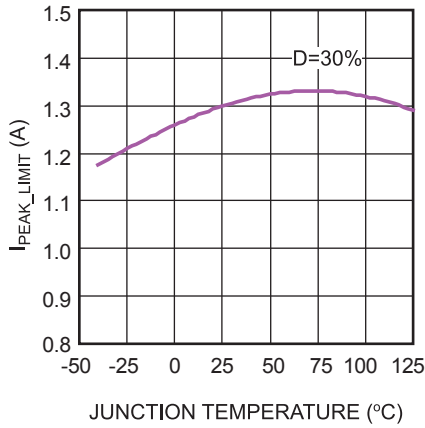
Current Limit vs. Junction Temperature



Frequency vs. Junction Temperature

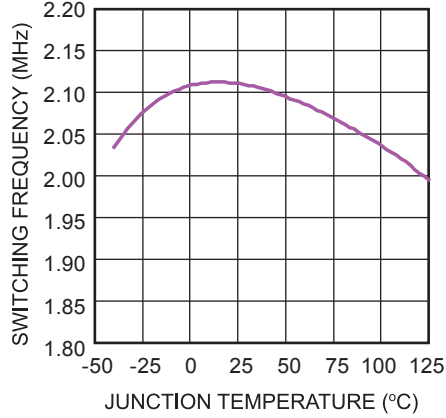

Voltage Reference vs. Junction Temperature

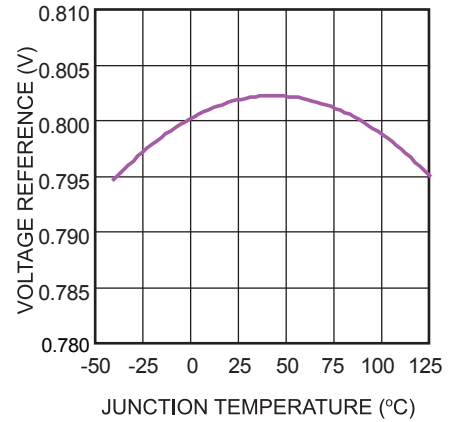

Efficiency

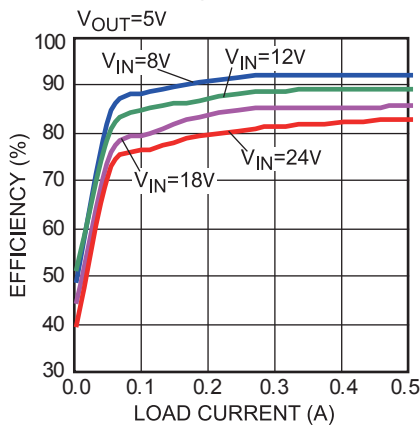

Steady State

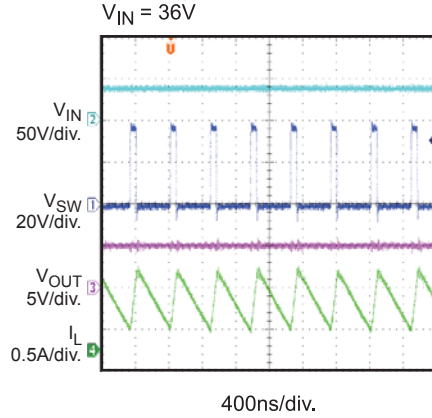

Short Output

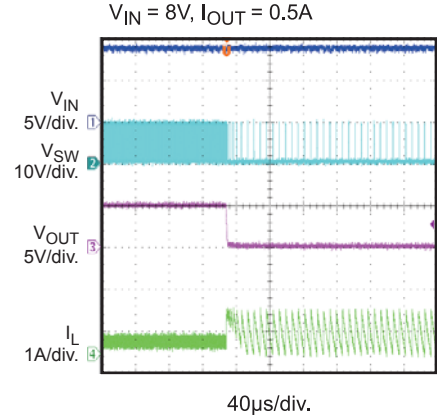

Power Ramp Up

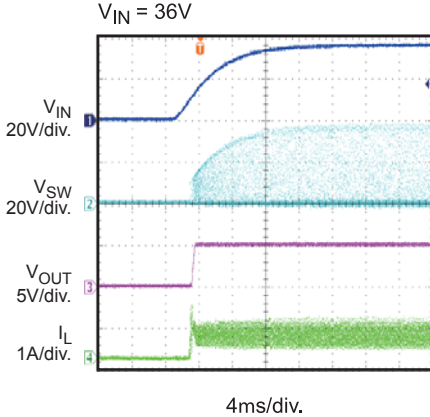

Power Ramp Down

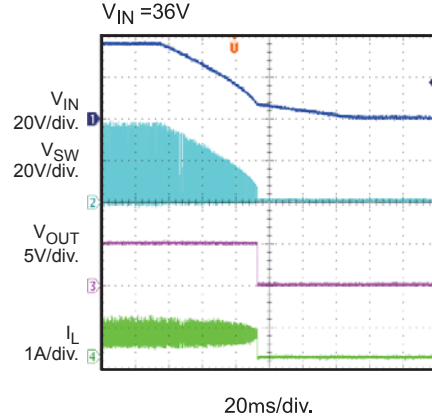

Load Transient

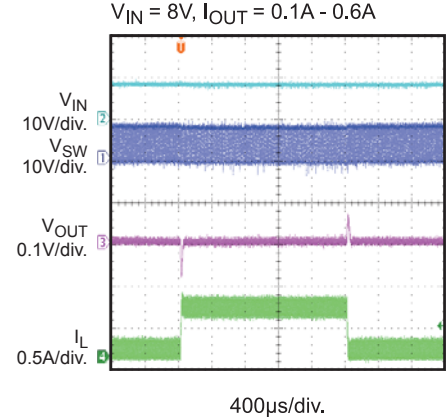

EVB TEST RESULTS *(continued)*

Conduction EMI Performance
12V to 5V, 0.3A

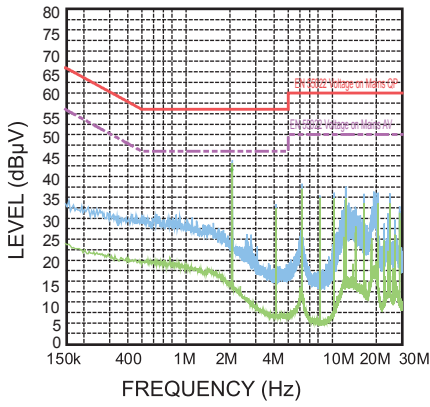

Conduction Ambient Noise

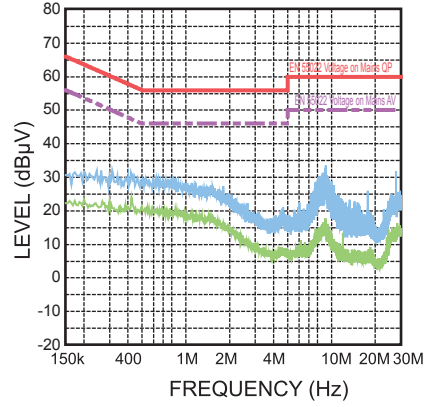

Radiation EMI Performance
12V to 5V, 0.3A

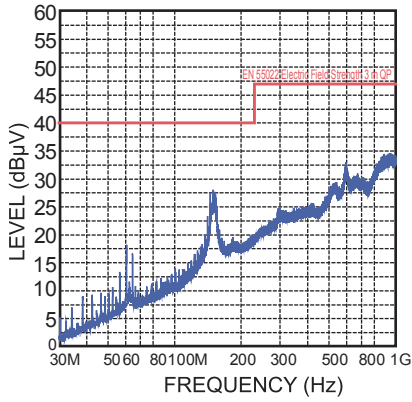

Radiation Ambient Noise

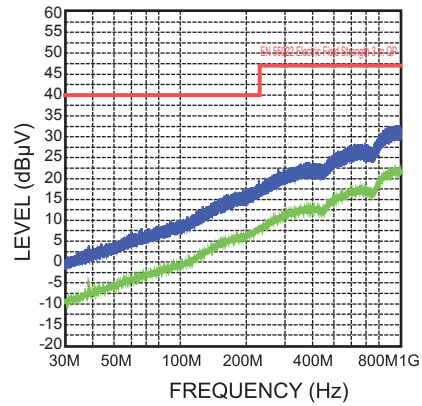

PRINTED CIRCUIT BOARD LAYOUT

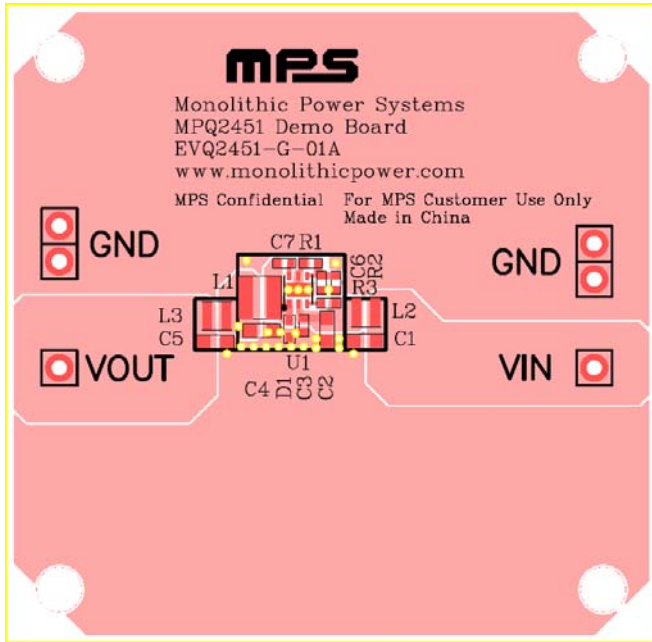

Figure 1—Top and Top Silk Layer

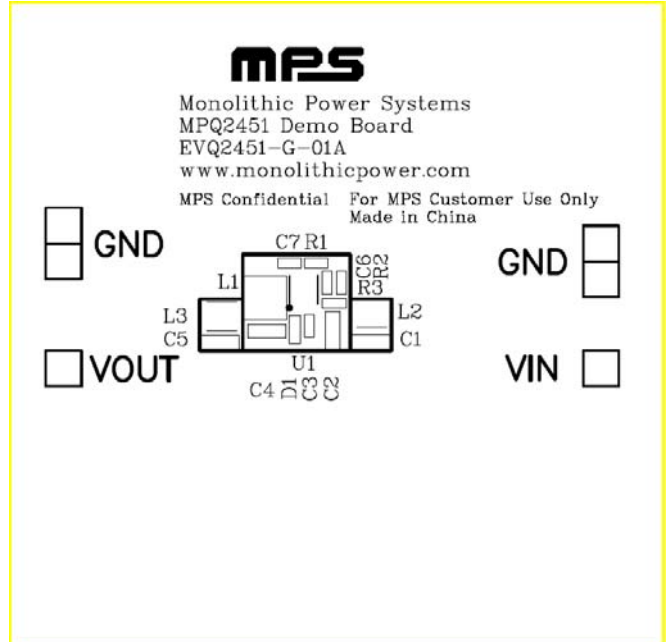

Figure 2—Top and Silk Layer

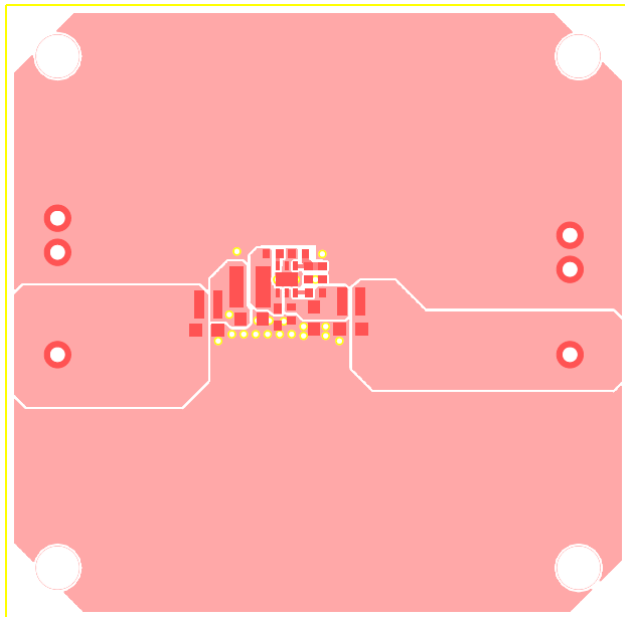

Figure 3- Top Layer

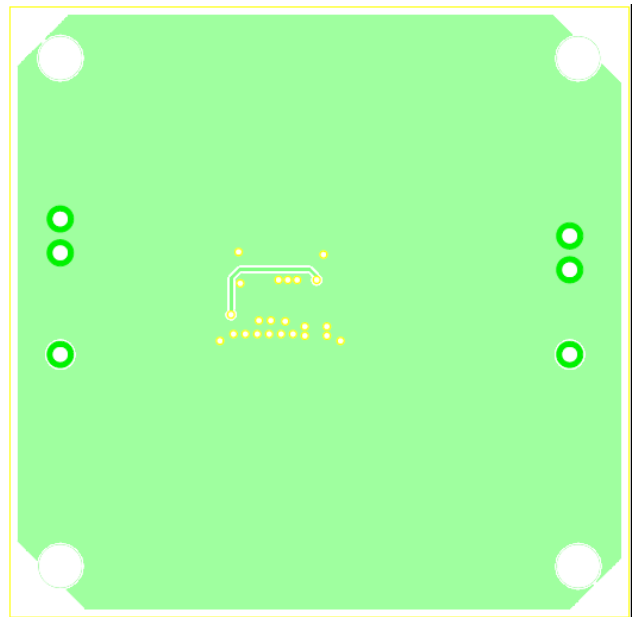

Figure 4—Bottom Layer

QUICK START GUIDE

1. Connect the positive terminal of the load to VOUT pins, and the negative terminal of the load to GND pins.
2. Preset the power supply output to 12V and turn off the power supply.
3. Connect the positive terminal of the power supply output to the VIN pin and the negative terminal of the power supply output to the GND pin.
4. Turn on the power supply. The EVQ2451 will automatically start up.
5. To use the Enable function, apply a digital input to the EN pin. Drive EN higher than 1.8V to turn on the regulator or less than 1.2V to turn it off. Note that floating the EN pin will turn it off.
6. To adjust the output voltage, change the values of R1 and R2. Generally, Choose R2 around 124k Ω for optimal transient response. For $V_{FB}=0.8V$, R2=124k Ω , R1 can be determined by:

$$R1 = \frac{124k\Omega}{V_{OUT}-0.8V}$$

Please follow the application information on the MP2451 datasheet to recalculate/select compensation values, the inductor value and the output capacitor value if the output voltage needs to be reprogrammed.

NOTICE: The information in this document is subject to change without notice. Users should warrant and guarantee that third party Intellectual Property rights are not infringed upon when integrating MPS products into any application. MPS will not assume any legal responsibility for any said applications.