



EVQ4436-R-01A

45V, 6A, Low I_Q, Synchronous, Step-Down Converter Evaluation Board

DESCRIPTION

The EVQ4436-R-01A is an evaluation board designed to demonstrate the capabilities of the MPQ4436-AEC1, MPQ4436, and MP4436.

The MPQ4436 is a configurable-frequency, synchronous, step-down switching regulator with integrated internal high-side and low-side power MOSFETs. It provides up to 6A of highly efficient output, with current mode control for fast loop response.

The wide 3.3V to 45V input range accommodates a variety of step-down applications in an automotive input environment. A 1.7μA shutdown mode quiescent current allows the part to be used in battery-powered applications.

High power conversion efficiency across a wide load range is achieved by scaling down the switching frequency under light-load conditions to reduce the switching and gate driver losses.

Frequency foldback prevents inductor current runaway during start-up. Thermal shutdown provides reliable, fault-tolerant operation.

High duty cycle and low-dropout mode are provided for automotive cold crank conditions.

ELECTRICAL SPECIFICATIONS

| Parameter | Symbol | Value | Units |
|----------------|------------------|-----------|-------|
| Input voltage | V _{EMI} | 3.3 to 45 | V |
| Output voltage | V _{OUT} | 3.3 | V |
| Output current | I _{OUT} | 6 | A |

FEATURES

- Wide 3.3V to 45V Operating Voltage Range
- 6A Continuous Output Current
- 1.7μA Low Shutdown Supply Current
- 18μA Sleep Mode Quiescent Current
- Internal 48mΩ High-Side and 20mΩ Low-Side MOSFETs
- 350kHz to 530kHz Configurable Switching Frequency for Car Battery Applications
- Synchronize to External Clock
- Multi-Phase Capability
- Out-of-Phase Synchronized Clock Output
- Symmetric V_{IN} for Low EMI
- Power Good Output
- External Soft Start
- 100ns Minimum On Time
- Selectable Advanced Asynchronous Mode (AAM) or Forced Continuous Conduction Mode (FCCM)
- Low-Dropout Mode
- Hiccup Over-Current Protection
- Available in a QFN-20 (4mmx4mm) Wettable Flank Package
- Available in AEC-Q100 Grade 1

APPLICATIONS

- Infotainment
- Clusters
- Advanced Driver Assistance Systems
- Industrial Power Systems

All MPS parts are lead-free, halogen-free, and adhere to the RoHS directive. For MPS green status, please visit the MPS website under Quality Assurance. "MPS", the MPS logo, and "Simple, Easy Solutions" are trademarks of Monolithic Power Systems, Inc. or its subsidiaries.

EVQ4436-R-01A EVALUATION BOARD

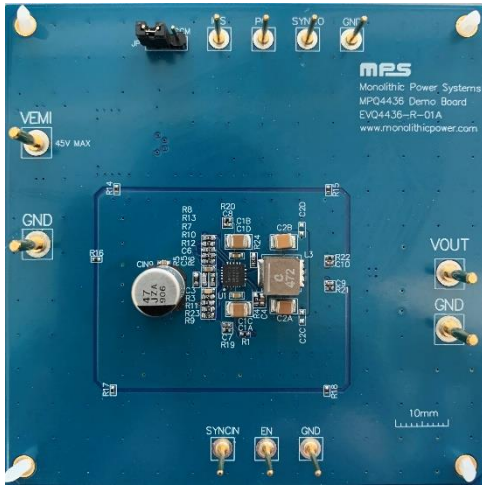

(LxWxH) 9cmx9cmx1.3cm

| Board Number | MPS IC Number |
|---------------|----------------|
| EVQ4436-R-01A | MPQ4436GR-AEC1 |

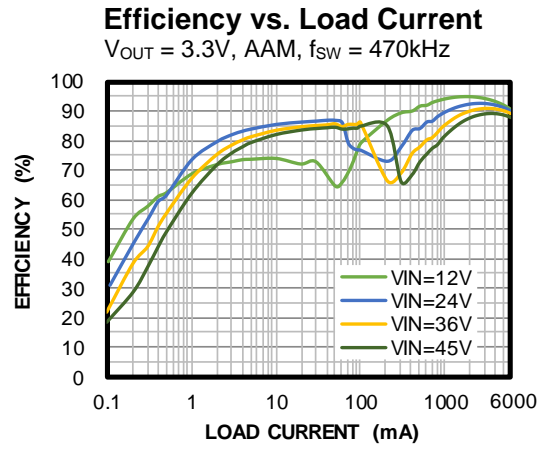

QUICK START GUIDE

1. Connect the load to:
 - a. Positive (+): VOUT
 - b. Negative (-): GND
2. Set the load current between 0A and 6A. Electronic loads represent a negative impedance to the regulator. If they are set to an exceedingly high current, they can trigger over-current or short-current protection.
3. Preset the power supply output between 3.3V and 45V, then turn it off. If longer cables are used between the source and the board (>0.5m total), install a damping capacitor at the input terminals. This is highly recommended when $V_{EMI} \geq 24V$.
3. Connect the power supply output to:
 - a. Positive (+): VEMI
 - b. Negative (-): GND
4. Turn the power supply on. The board should automatically start up. The default V_{OUT} is 3.3V.
5. To use the enable function, apply a digital input to the EN pin. Drive EN above 1V to turn the regulator on; drive EN below 0.85V to turn the regulator off.
6. To use the sync function, apply a 350kHz to 530kHz external clock to the SYNCIN pin to synchronize the internal clock's rising edge.
7. JP1 selects forced continuous conduction mode (FCCM) or advanced asynchronous mode (AAM). Connect pin 2 (MODE) to pin 3 (VCC) of JP1 to force the MPQ4436 into FCCM. Connect pin 1 (GND) to pin 2 (MODE) of JP1 to force the MPQ4436 into AAM.

EVALUATION BOARD SCHEMATIC

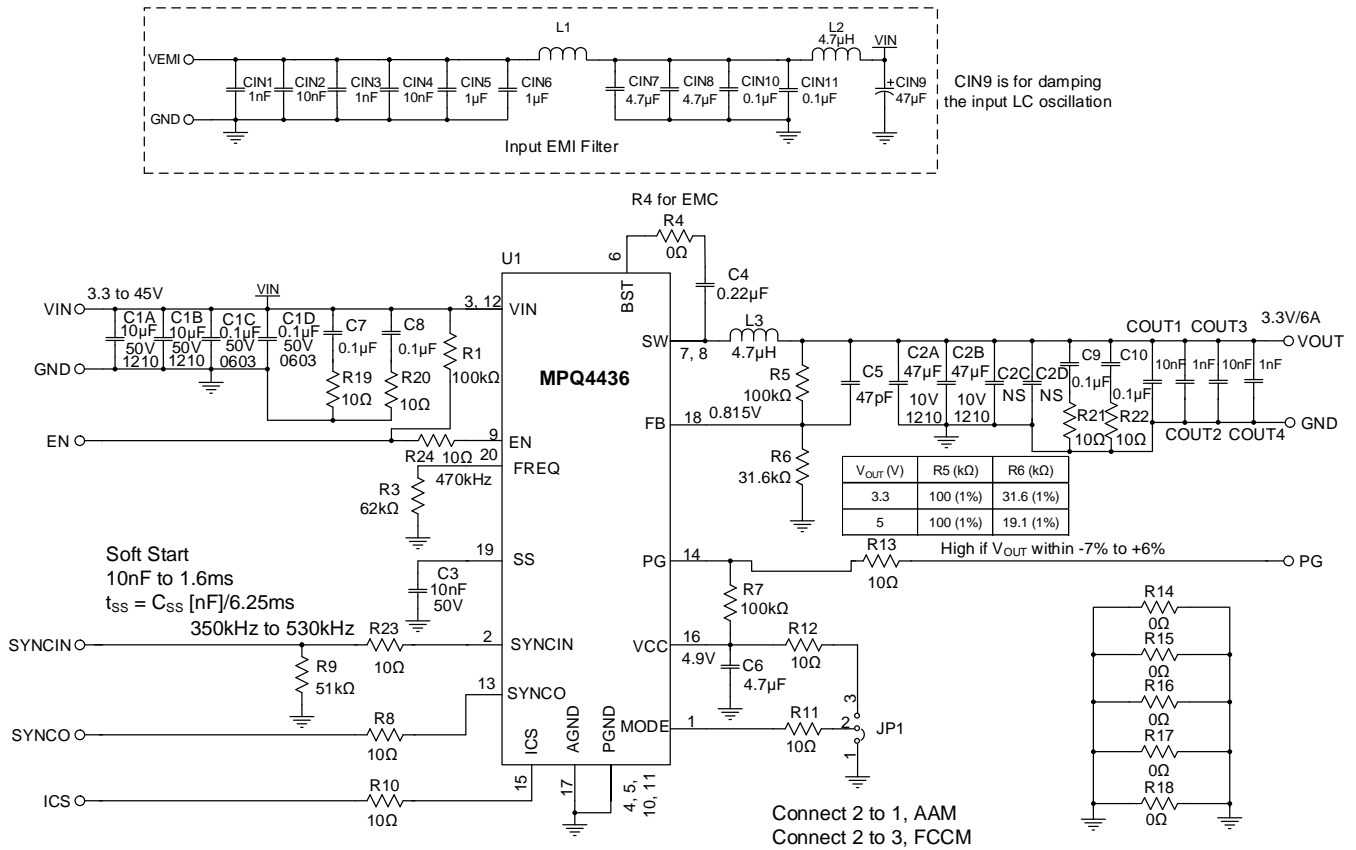

Package Reference

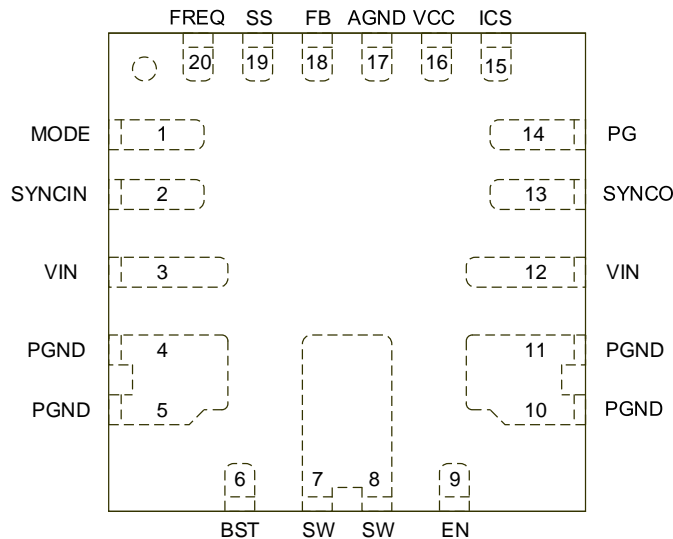

Figure 1: Evaluation Board Schematic

EVQ4436-R-01A BILL OF MATERIALS

| Qty | Ref | Value | Description | Package | Manufacturer | Manufacturer P/N |
|-----|---------------------------------------|----------------|--------------------------------------|---------|--------------|--------------------|
| 4 | CIN1, CIN3, COUT2, COUT4 | 1nF | Ceramic capacitor, 50V, X7R | 0603 | Murata | GRM216R71H102KA01 |
| 5 | CIN2, CIN4, C3, COUT1, COUT3 | 10nF | Ceramic capacitor, 50V, X7R | 0603 | Murata | GRM188R71H103KA01D |
| 2 | CIN5, CIN6 | 1 μ F | Ceramic capacitor, 50V, X7R | 0805 | Murata | GRM21BR71H105KA12L |
| 2 | CIN7, CIN8 | 10 μ F | Ceramic capacitor, 50V, X5R | 1206 | Murata | GRM31CR61H106KA12L |
| 1 | CIN9 | 47 μ F | Aluminum capacitor, 63V | SMD | Panasonic | EEE-1JA470UP |
| 2 | C1A, C1B | 10 μ F | Ceramic capacitor, 50V, X7R | 1210 | Murata | GRM32ER71H106KA12L |
| 4 | CIN10, CIN11, C1C, C1D | 0.1 μ F | Ceramic capacitor, 50V, X7R | 0603 | Murata | GCJ188R71H104KA12D |
| 2 | C2A, C2B | 47 μ F | Ceramic capacitor, 10V, X5R | 1210 | Murata | GRM32ER61A476KE20L |
| 1 | C4 | 0.22 μ F | Ceramic capacitor, 16V, X7R | 0603 | Murata | GRM188R71C122KA01D |
| 1 | C5 | 47pF | Ceramic capacitor, 50V, COG | 0603 | TDK | C1608C0G1H470J |
| 1 | C6 | 4.7 μ F | Ceramic capacitor, 10V, X5R | 0603 | Murata | GRM188R61A475KE15D |
| 4 | C7, C8, C9, C10 | 0.1 μ F | Ceramic capacitor, 50V, X7R | 0402 | Murata | GRM155R71H104KE14D |
| 2 | C2C, C2D | NS | | | | |
| 1 | L1 | | Magnetic bead, 6A | 1806 | Murata | BLM41PG600SN1L |
| 1 | L2 | 4.7 μ H | Inductor, 4.7 μ H, 31.5m, 6A | SMD | Cyntec | VCMT063T-4R7MN5T |
| 1 | L3 | 4.7 μ H | Inductor, 4.7 μ H, 14.4m, 11A | SMD | Coilcraft | XAL6060-472ME |
| 1 | R1 | 100k Ω | Film resistor, 1% | 0402 | Yageo | RC0402FR-07100KL |
| 1 | R3 | 62k Ω | Film resistor, 1% | 0603 | Yageo | RC0603FR-062KL |
| 5 | R14, R15, R16, R17, R18 | 0 Ω | Film resistor, 1% | 0402 | Yageo | RC0402FR-070RL |
| 1 | R4 | 0 Ω | Film resistor, 5% | 0603 | Yageo | RC0603JR-070RL |
| 1 | R5 | 100k Ω | Film resistor, 1% | 0603 | Yageo | RC0603FR-07100KL |
| 1 | R6 | 31.6k Ω | Film resistor, 1% | 0603 | Yageo | RC0603FR-0731K6L |
| 1 | R7 | 100k Ω | Film resistor, 1% | 0603 | Yageo | RC0603FR-07100KL |
| 1 | R9 | 51k Ω | Film resistor, 1% | 0603 | Yageo | RC0603FR-0751KL |

EVQ4436-R-01A BILL OF MATERIALS (continued)

| Qty | Ref | Value | Description | Package | Manufacturer | Manufacturer P/N |
|-----|--|------------|--|---------------------|--------------|------------------|
| 4 | R19, R20, R21, R22 | 10Ω | Film resistor, 5% | 0402 | Yageo | RC0402FR-0710RL |
| 7 | R8, R10, R11, R12, R13, R23, R24 | 10Ω | Film resistor, 1% | 0603 | Yageo | RC0603FR-0710RL |
| 1 | U1 | MPQ4436 | Step-down converter | QFN-20 (4mmx4mm) | MPS | MPQ4436GR-AEC1 |
| 1 | JP1 | | Connector, 2x20, 2.54mm, right angle | | Any | |
| 5 | VIN, VEMI, GND, VOUT, GND | Test point | 2.0 golden pin | | Custom | |
| 8 | SS, SYNCIN, FB, ICS, PG, SYNCO, EN, GND | Test point | 1.0 golden pin | | Custom | |

EVB TEST RESULTS

Performance curves and waveforms are tested on the evaluation board. $V_{IN} = 12V$, $V_{OUT} = 3.3V$, $L = 4.7\mu H$, $f_{SW} = 470kHz$, $T_A = 25^\circ C$, unless otherwise noted.

Efficiency vs. Load Current
AAM

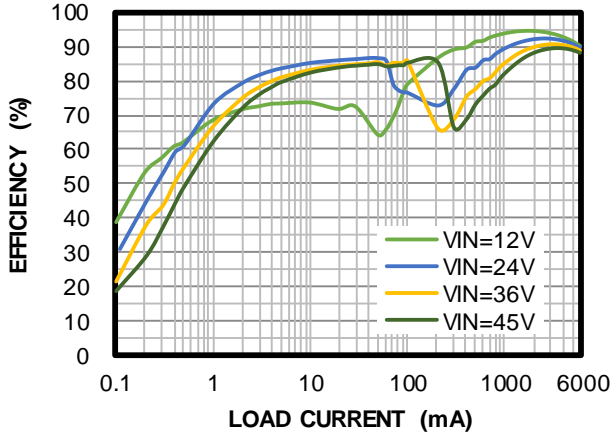

Efficiency vs. Load Current
CCM

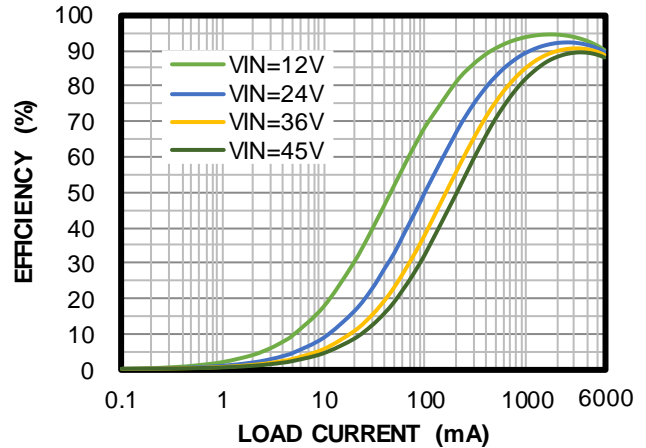

Efficiency vs. Load Current
AAM, extreme light-load conditions

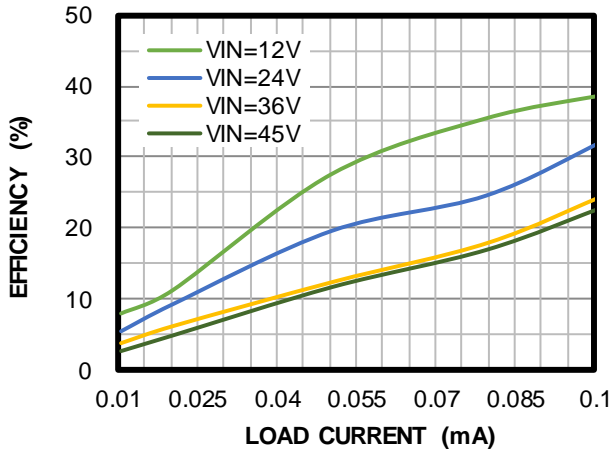

Efficiency vs. Load Current
CCM, extreme light-load conditions

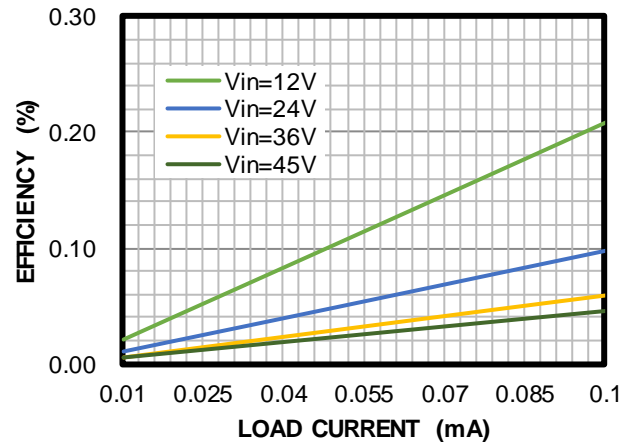

EVB TEST RESULTS (continued)

Performance curves and waveforms are tested on the evaluation board. $V_{IN} = 12V$, $V_{OUT} = 3.3V$, $L = 4.7\mu H$, $f_{SW} = 470kHz$, AAM, $T_A = 25^\circ C$, unless otherwise noted.

Steady State

$I_{OUT} = 0A$, AAM

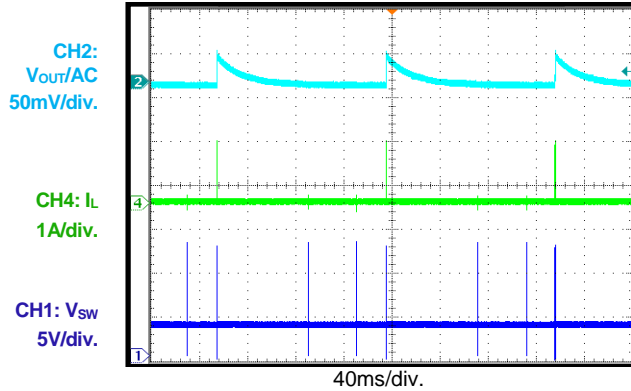

Steady State

$I_{OUT} = 0A$, FCCM

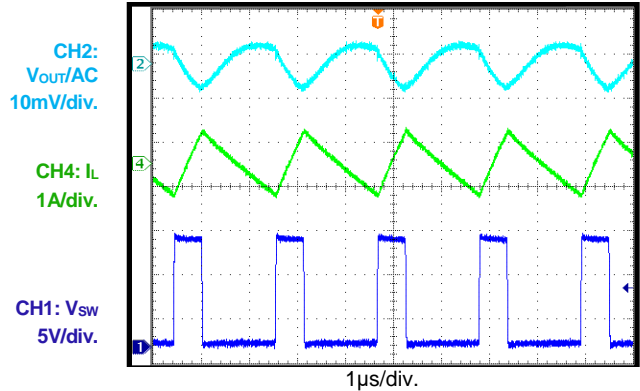

Steady State

$I_{OUT} = 6A$

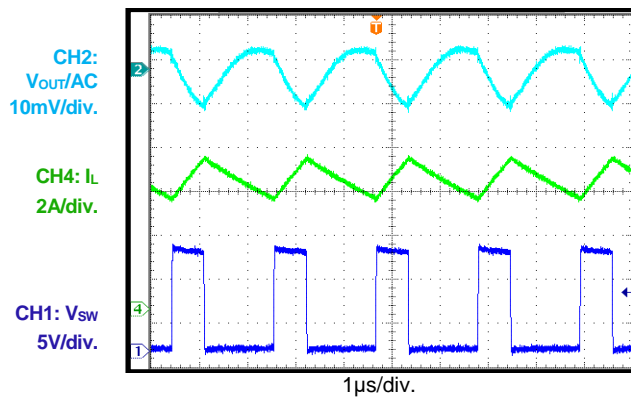

Start-Up through VIN

$I_{OUT} = 0A$, AAM

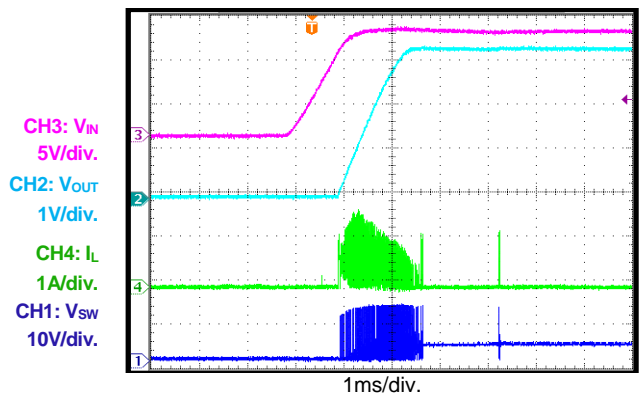

Start-Up through VIN

$I_{OUT} = 0A$, FCCM

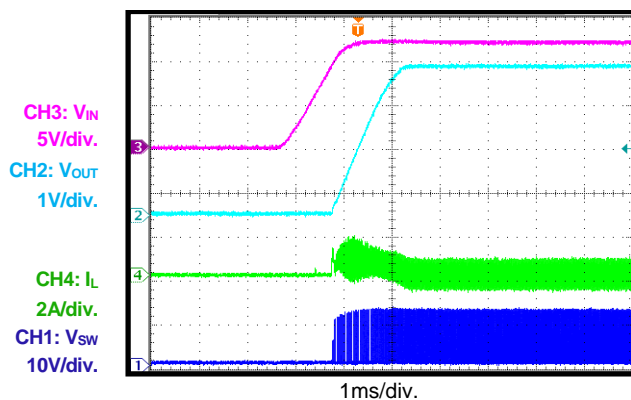

Start-Up through VIN

$I_{OUT} = 6A$

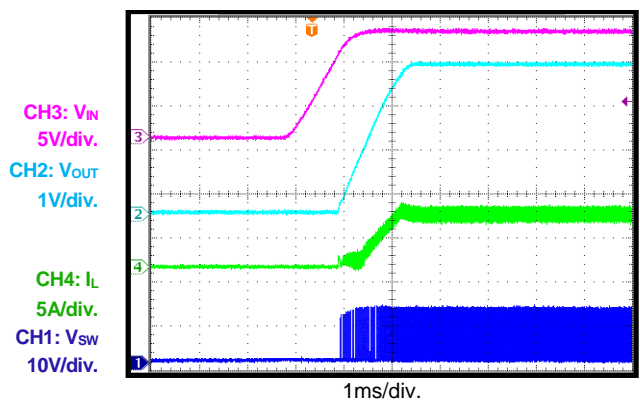

EVB TEST RESULTS (continued)

Performance curves and waveforms are tested on the evaluation board. $V_{IN} = 12V$, $V_{OUT} = 3.3V$, $L = 4.7\mu H$, $f_{SW} = 470kHz$, AAM, $T_A = 25^\circ C$, unless otherwise noted.

Shutdown through V_{IN}

$I_{OUT} = 0A$, AAM

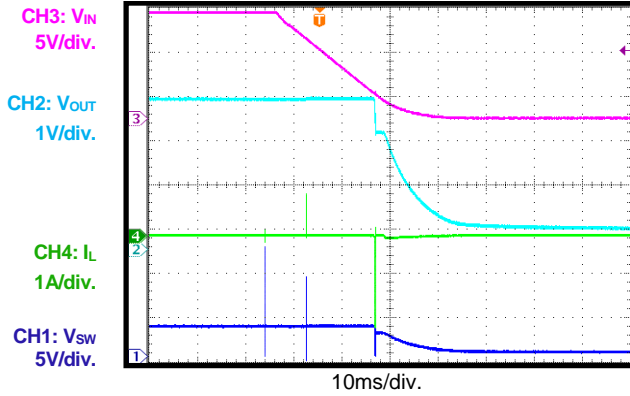

Shutdown through V_{IN}

$I_{OUT} = 0A$, FCCM

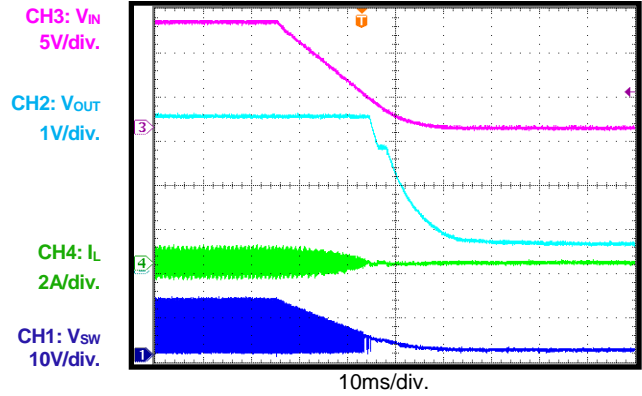

Shutdown through V_{IN}

$I_{OUT} = 6A$

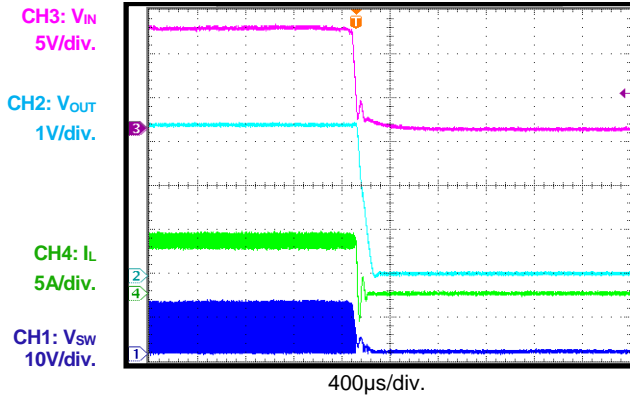

Start-Up through EN

$I_{OUT} = 0A$, AAM

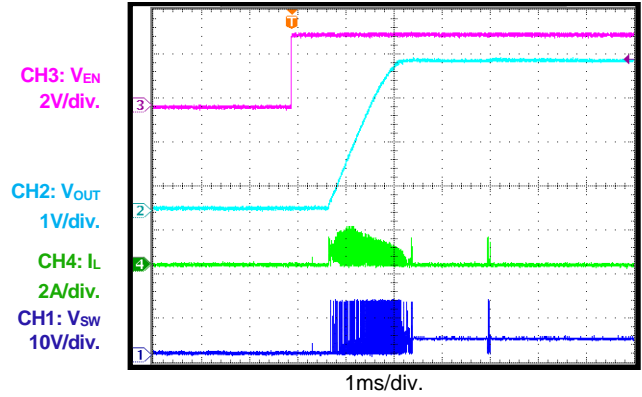

Start-Up through EN

$I_{OUT} = 0A$, FCCM

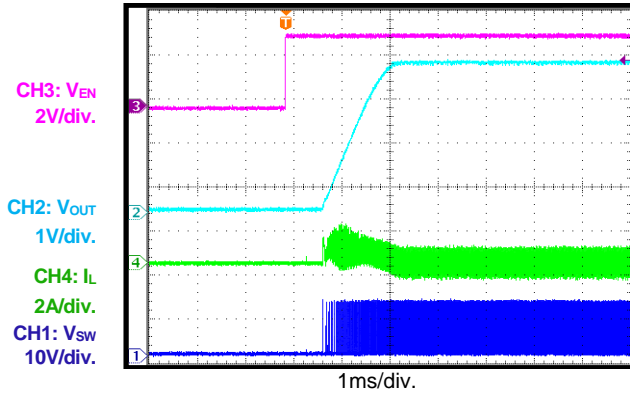

Start-Up through EN

$I_{OUT} = 6A$

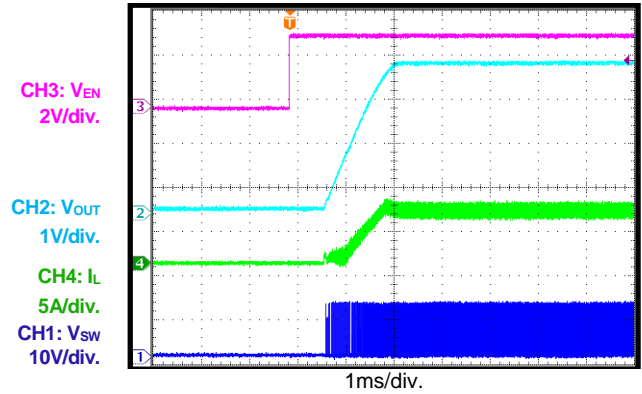

EVB TEST RESULTS (continued)

Performance curves and waveforms are tested on the evaluation board. $V_{IN} = 12V$, $V_{OUT} = 3.3V$, $L = 4.7\mu H$, $f_{SW} = 470kHz$, AAM, $T_A = 25^\circ C$, unless otherwise noted.

Shutdown through EN

$I_{OUT} = 0A$, AAM

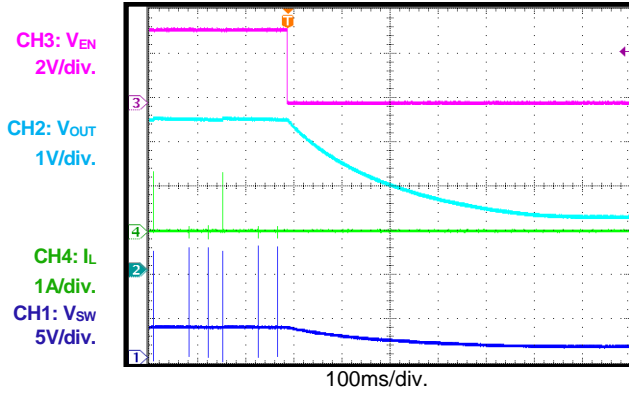

Shutdown through EN

$I_{OUT} = 0A$, FCCM

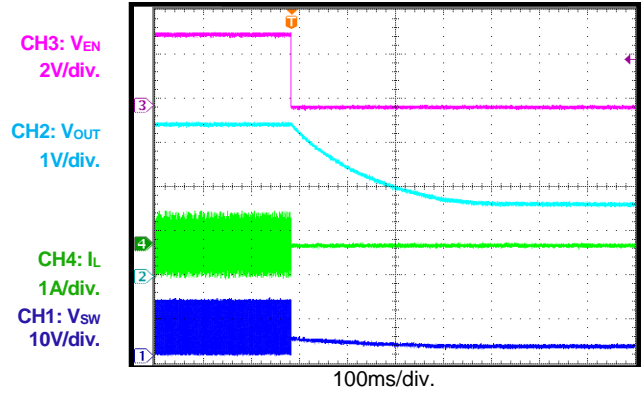

Shutdown through EN

$I_{OUT} = 6A$

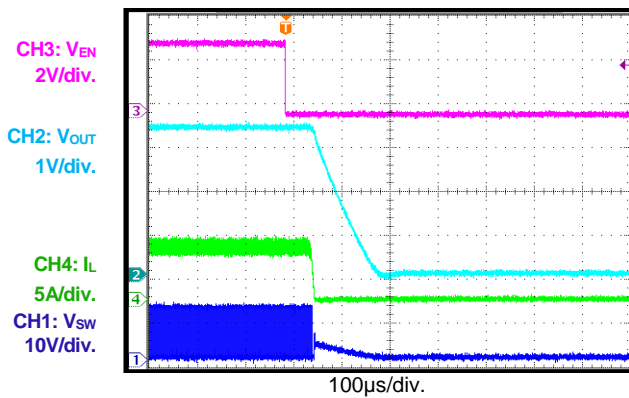

SCP Entry

$I_{OUT} = 0A$, AAM

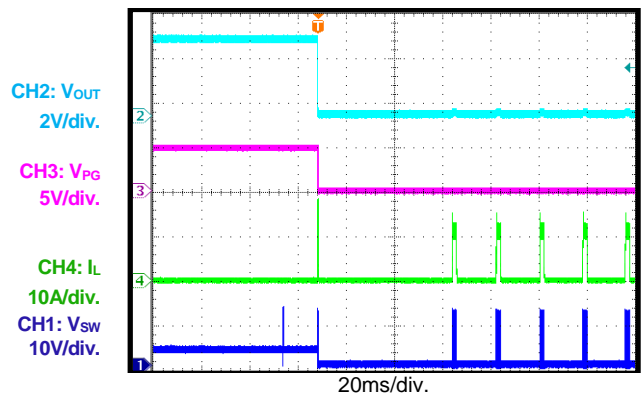

SCP Entry

$I_{OUT} = 0A$, FCCM

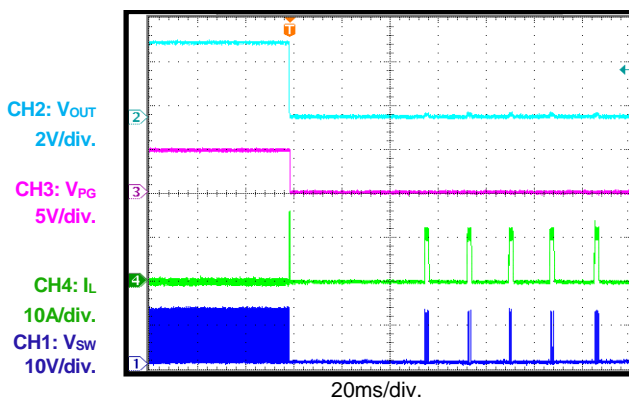

SCP Entry

$I_{OUT} = 6A$

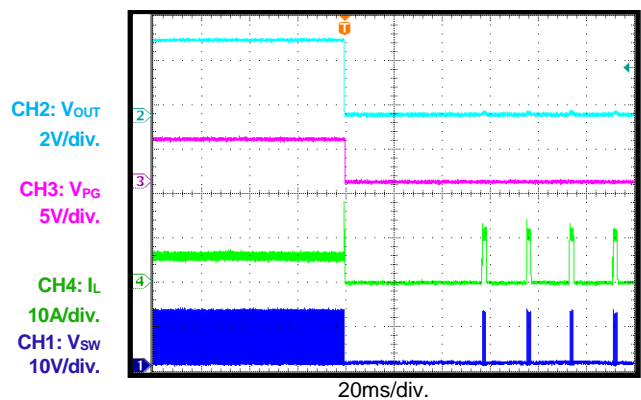

EVB TEST RESULTS (continued)

Performance curves and waveforms are tested on the evaluation board. $V_{IN} = 12V$, $V_{OUT} = 3.3V$, $L = 4.7\mu H$, $f_{SW} = 470kHz$, AAM, $T_A = 25^\circ C$, unless otherwise noted.

SCP Recovery

$I_{OUT} = 0A$, AAM

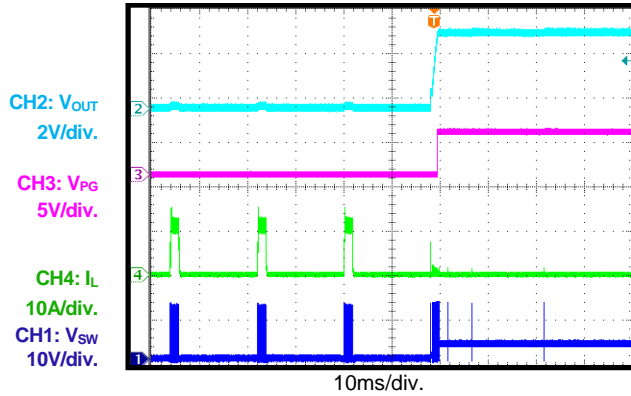

SCP Recovery

$I_{OUT} = 0A$, FCCM

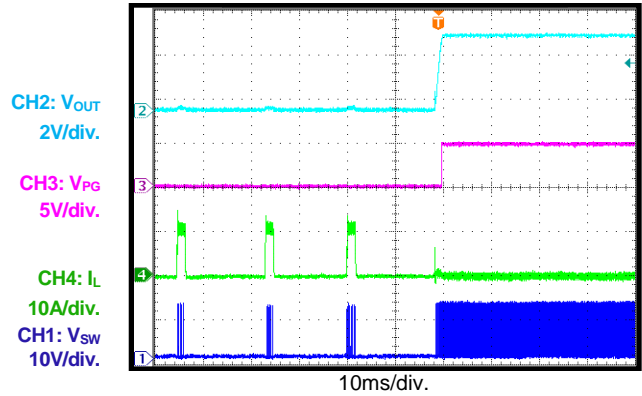

SCP Recovery

$I_{OUT} = 6A$

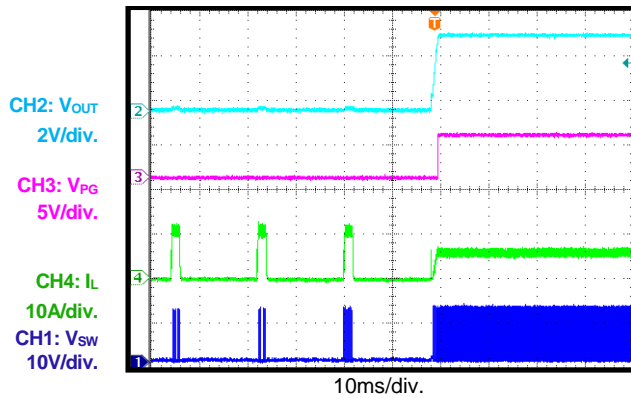

SCP Steady State

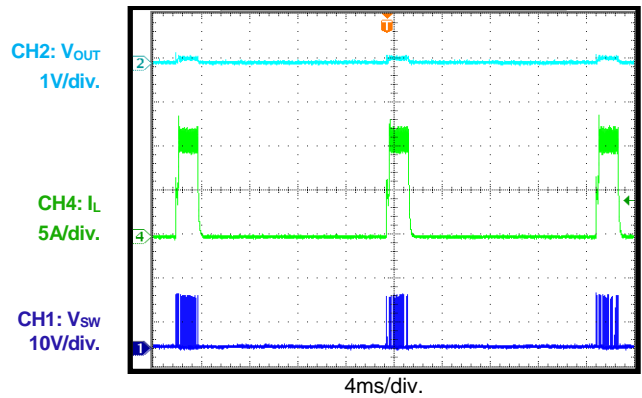

Load Transient

$I_{OUT} = 3A$ to $6A$

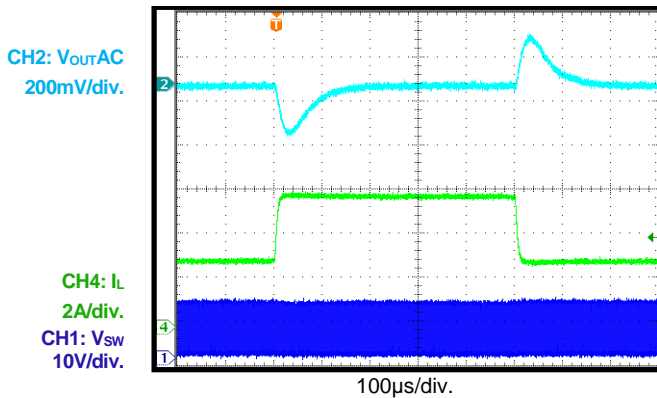

SYNC Operation

$I_{OUT} = 6A$, SYNC frequency = 350kHz

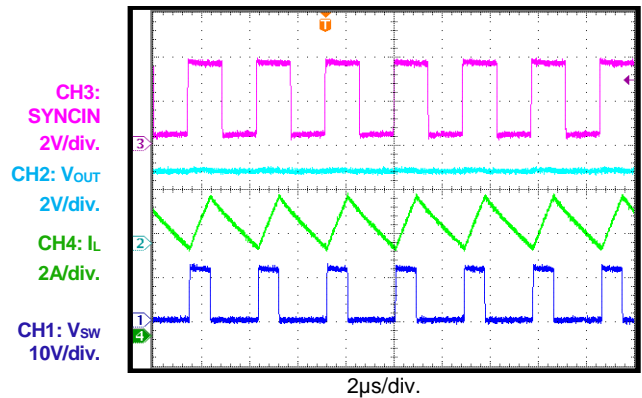

EVB TEST RESULTS (continued)

Performance curves and waveforms are tested on the evaluation board. $V_{IN} = 12V$, $V_{OUT} = 3.3V$, $L = 4.7\mu H$, $f_{SW} = 470kHz$, AAM, $T_A = 25^\circ C$, unless otherwise noted.

SYNC Operation

$I_{OUT} = 6A$, SYNC frequency = 530kHz

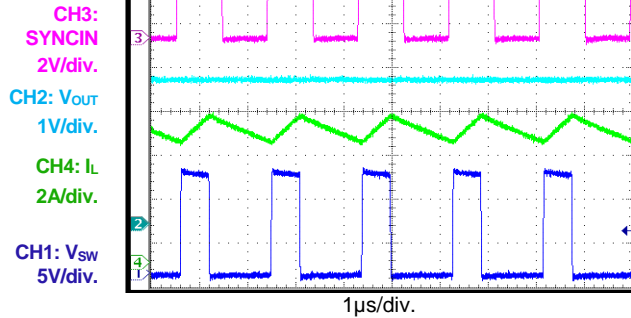

SYNC Operation

$I_{OUT} = 6A$, SYNC frequency = 350kHz

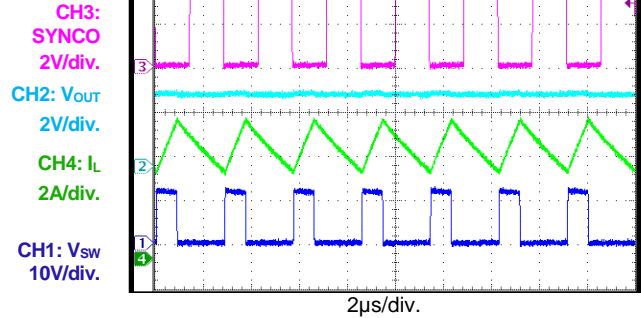

SYNCO Operation

$I_{OUT} = 6A$, SYNC frequency = 530kHz

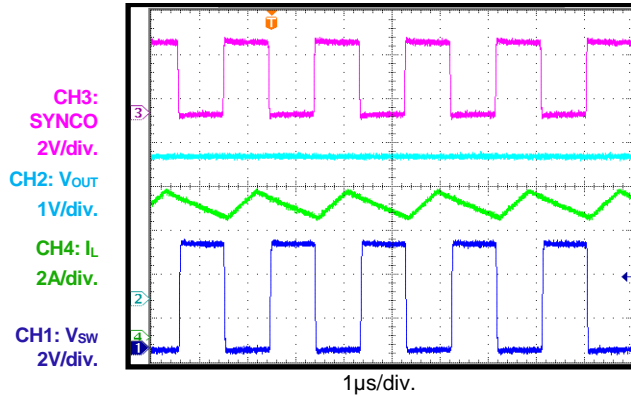

PG Start-Up through VIN

$I_{OUT} = 0A$

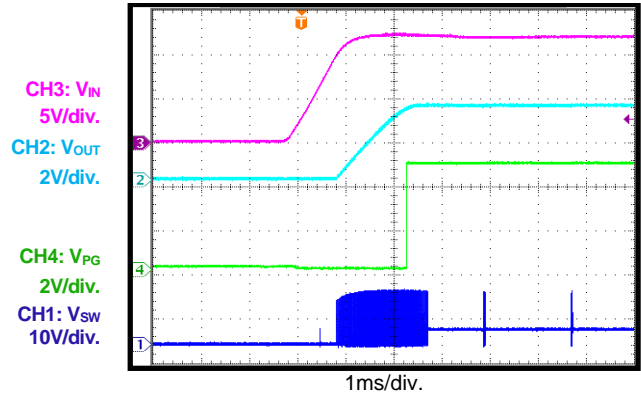

PG Start-Up through VIN

$I_{OUT} = 6A$

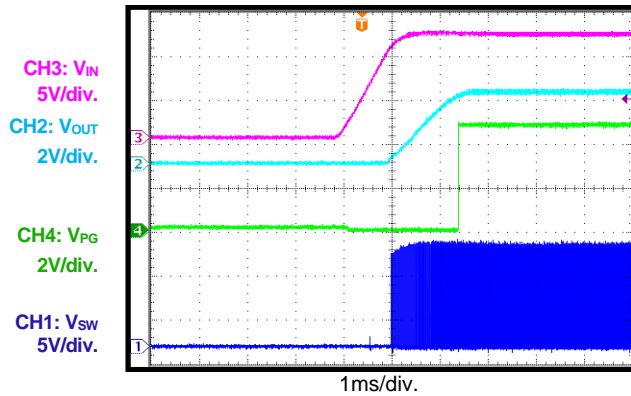

PG Shutdown through VIN

$I_{OUT} = 0A$

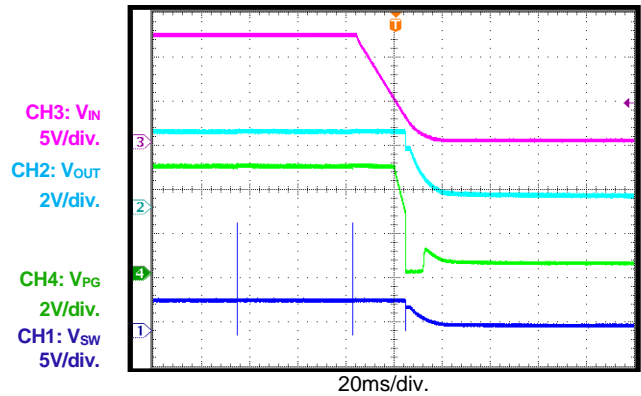

EVB TEST RESULTS (continued)

Performance curves and waveforms are tested on the evaluation board. $V_{IN} = 12V$, $V_{OUT} = 3.3V$, $L = 4.7\mu H$, $f_{SW} = 470kHz$, AAM, $T_A = 25^\circ C$, unless otherwise noted.

PG Shutdown through VIN

$I_{OUT} = 6A$

CH3: V_{IN}
5V/div.
CH2: V_{OUT}
2V/div.
CH4: V_{PG}
2V/div.
CH1: V_{SW}
5V/div.

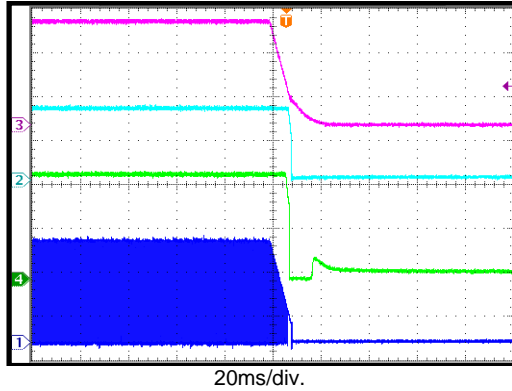

PG Start-Up through EN

$I_{OUT} = 0A$

CH3: V_{EN}
2V/div.
CH2: V_{OUT}
2V/div.
CH4: V_{PG}
2V/div.
CH1: V_{SW}
5V/div.

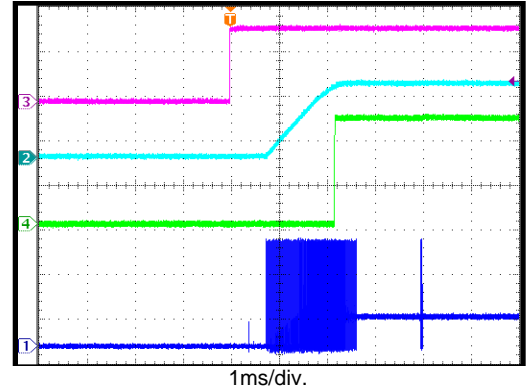

PG Start-Up through EN

$I_{OUT} = 6A$

CH3: V_{EN}
2V/div.
CH2: V_{OUT}
2V/div.
CH4: V_{PG}
2V/div.
CH1: V_{SW}
10V/div.

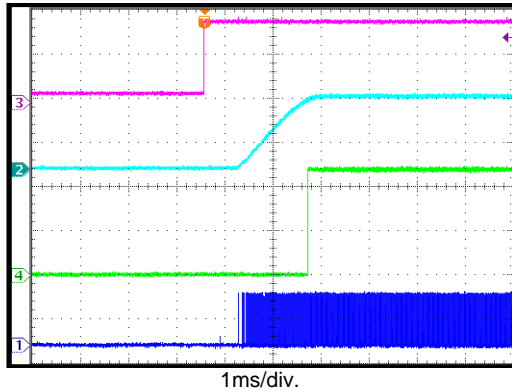

PG Shutdown through EN

$I_{OUT} = 0A$

CH3: V_{EN}
2V/div.
CH2: V_{OUT}
2V/div.
CH4: V_{PG}
2V/div.
CH1: V_{SW}
5V/div.

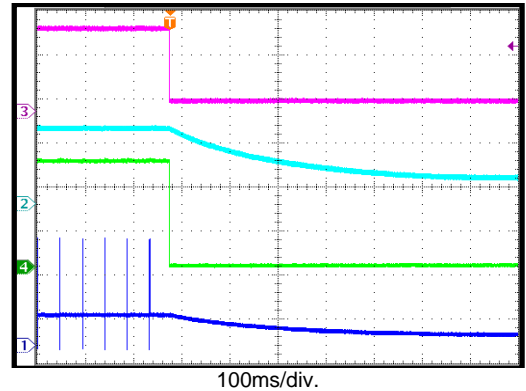

PG Shutdown through EN

$I_{OUT} = 6A$

CH3: V_{EN}
2V/div.
CH2: V_{OUT}
2V/div.
CH4: V_{PG}
2V/div.
CH1: V_{SW}
10V/div.

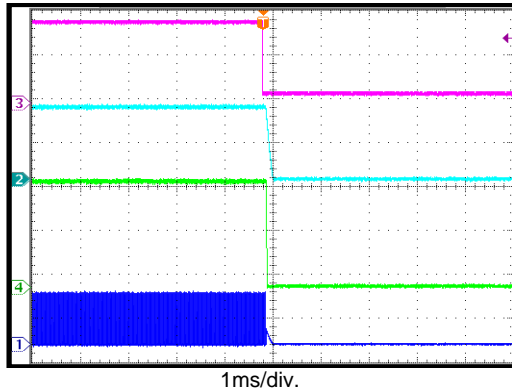

Low-Dropout Mode

$V_{IN} = 3.3V$, V_{OUT} set to 3.3V, $I_{OUT} = 0A$

CH3: V_{IN}
500mV/div.
CH2: V_{OUT}
500mV/div.
CH4: I_L
50mA/div.
CH1: V_{SW}
1V/div.

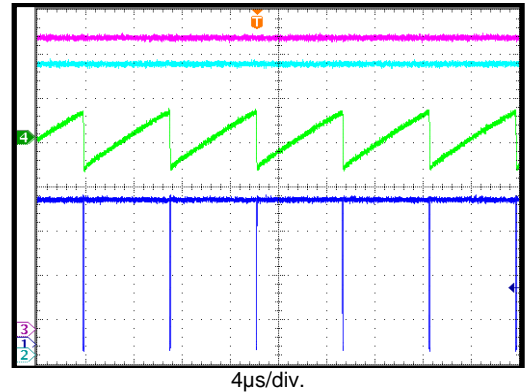

EVB TEST RESULTS (continued)

Performance curves and waveforms are tested on the evaluation board. $V_{IN} = 12V$, $V_{OUT} = 3.3V$, $L = 4.7\mu H$, $f_{SW} = 470kHz$, AAM, $T_A = 25^\circ C$, unless otherwise noted.

Dropout Operation

$V_{IN} = 3.3V$, V_{OUT} set to 3.3V, $I_{OUT} = 6A$

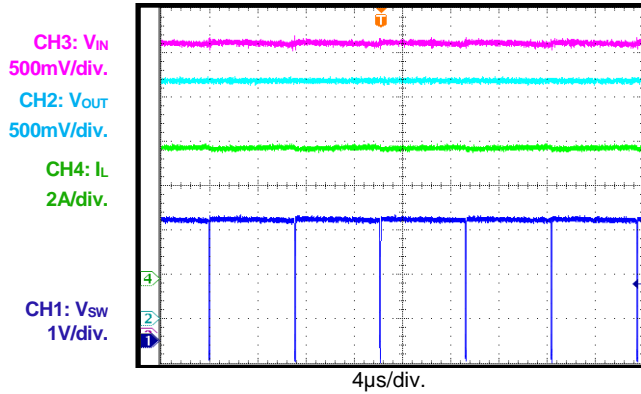

Load Dump

$V_{IN} = 12V$ to 36V, $I_{OUT} = 6A$

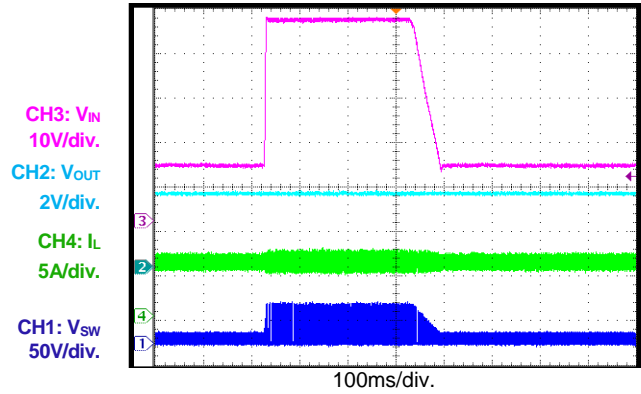

Cold Crank

$V_{IN} = 12V$ to 3.3V to 5V, $I_{OUT} = 6A$

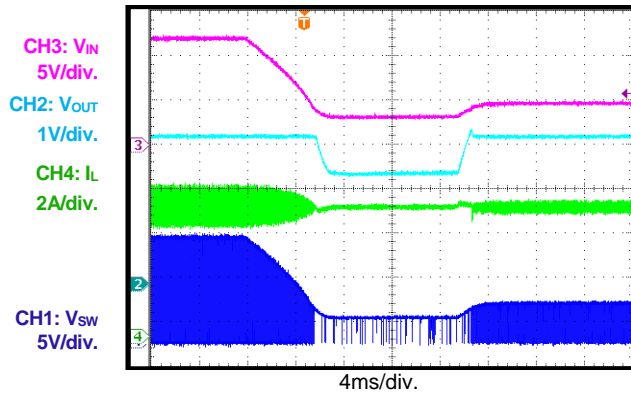

V_{IN} Ramp Up and Down

$I_{OUT} = 0.1A$

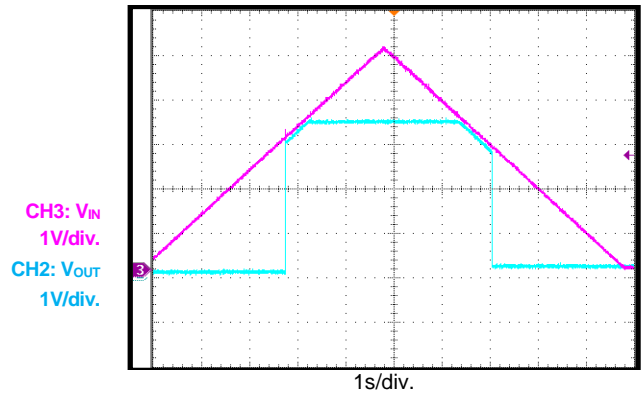

V_{IN} Ramp Down and Up

$I_{OUT} = 1mA$

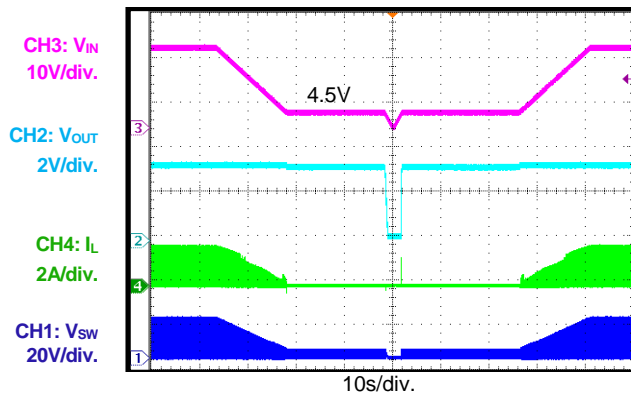

V_{IN} Ramp Down and Up

$I_{OUT} = 6A$

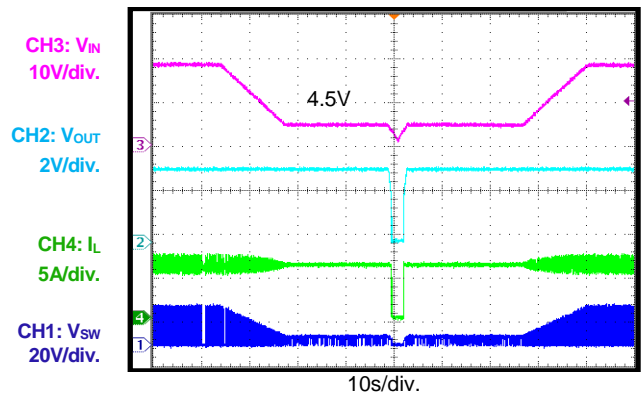

PCB LAYOUT

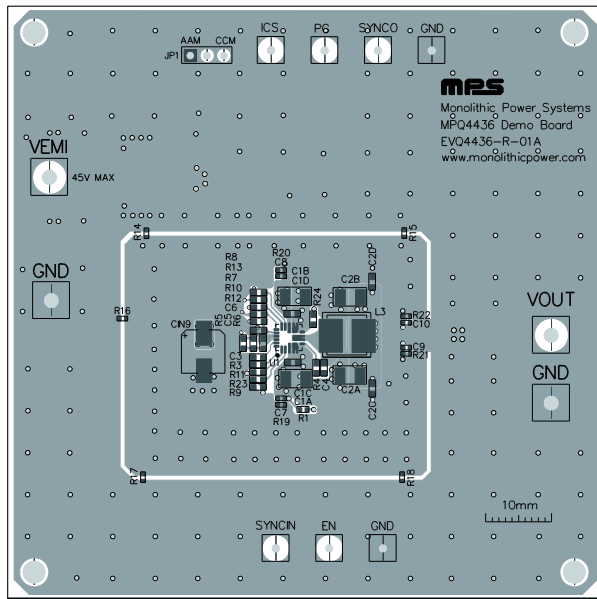

Figure 2: Top Silk Layer and Top Layer

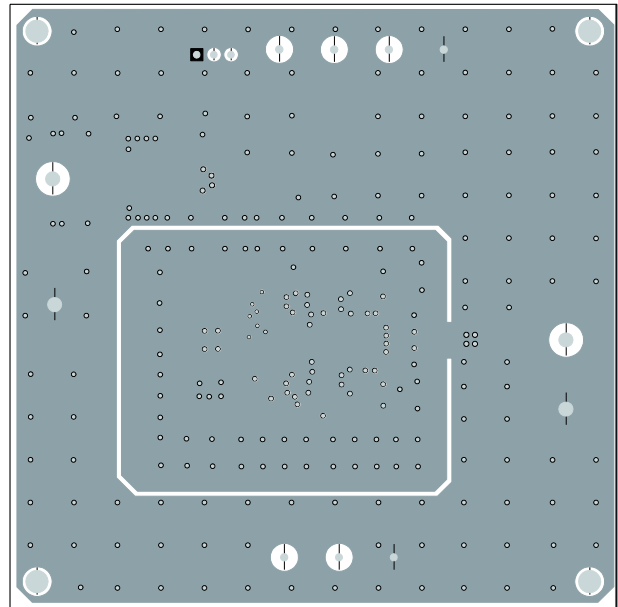

Figure 3: Inner Layer 1

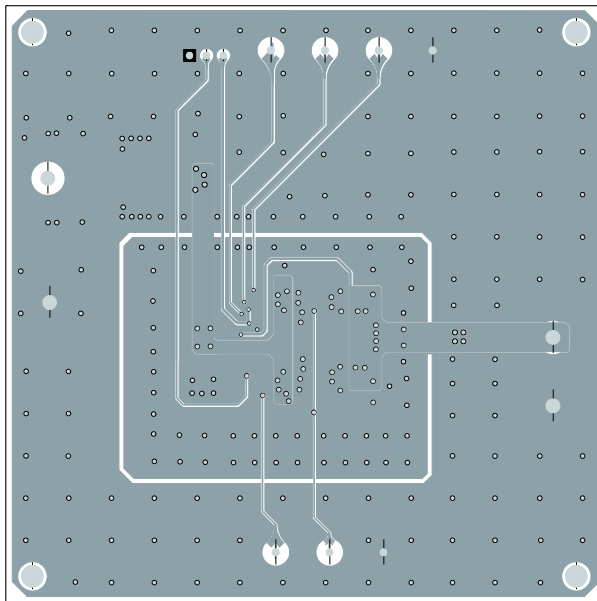

Figure 4: Inner Layer 2

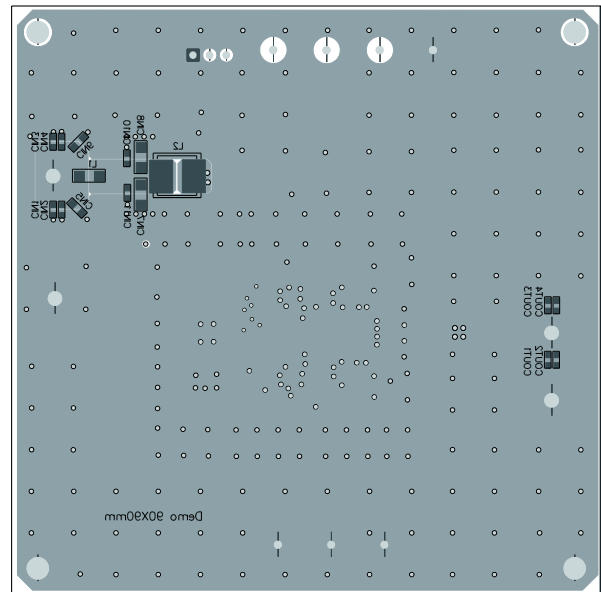

Figure 5: Bottom Silk Layer and Bottom Layer

Revision History

| Revision # | Revision Date | Description | Pages Updated |
|------------|---------------|-----------------|---------------|
| 1.0 | 8/31/2020 | Initial Release | - |

Notice: The information in this document is subject to change without notice. Please contact MPS for current specifications. Users should warrant and guarantee that third-party Intellectual Property rights are not infringed upon when integrating MPS products into any application. MPS will not assume any legal responsibility for any said applications.