

### DESCRIPTION

The EVQ4470-L-00A is an evaluation board for the MPQ4470, a high-efficiency step-down regulator with integrated power MOSFETs.

MPQ4470 offers a very compact solution to achieve a 5A, continuous-output current over a wide input-supply range with excellent load and line regulation. It also provides fast transient response and good stability for wide input-supply and load range.

The EVQ4470-L-00A is a fully assembled and tested evaluation board. It generates a +3.3V output voltage at load current up to 5A from an 4.5V to 36V input range. Switching frequency is set at 500kHz.

### ELECTRICAL SPECIFICATIONS

Parameter	Symbol	Value	Units
Input Voltage	$V_{IN}$	4.5 – 36	V
Output Voltage	$V_{OUT}$	3.3	V
Output Current	$I_{OUT}$	5	A

### FEATURES

- Wide 4.5V-to-36V Operating Input Range
- Guaranteed 5A, Continuous Output Current
- Internal 40mΩ High-Side, 20mΩ Low-Side Power MOSFETs
- Proprietary Switching-Loss-Reduction Technology
- 1% Reference Voltage
- Programmable Soft-Start Time
- Low Drop-out Mode
- SCP, OCP, OVP, UVP and Thermal Shutdown

### APPLICATIONS

- Notebook Systems and I/O Power
- Automotive Systems
- Networking Systems
- Industrial Supplies
- Optical Communications Systems
- Distributed Power and POL Systems

All MPS parts are lead-free and adhere to the RoHS directive. For MPS green status, please visit MPS website under Quality Assurance. "MPS" and "The Future of Analog IC Technology" are Registered Trademarks of Monolithic Power Systems, Inc.

## EVQ4470-L-00A EVALUATION BOARD



(L x W x H) 2.5" x 2.5" x 0.4"  
(6.4cm x 6.4cm x 1.0cm)

Board Number	MPS IC Number
EVQ4470-L-00A	MPQ4470GL

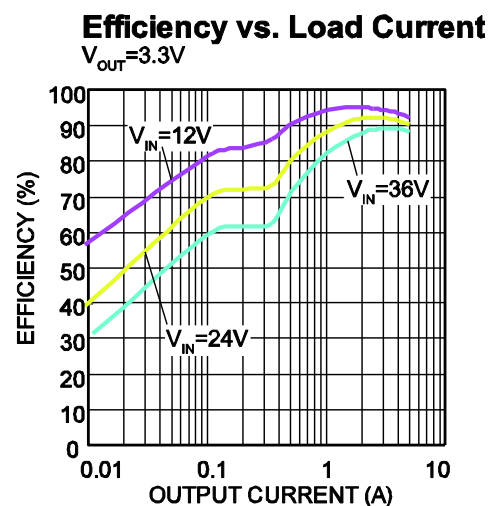

## EVALUATION BOARD SCHEMATIC

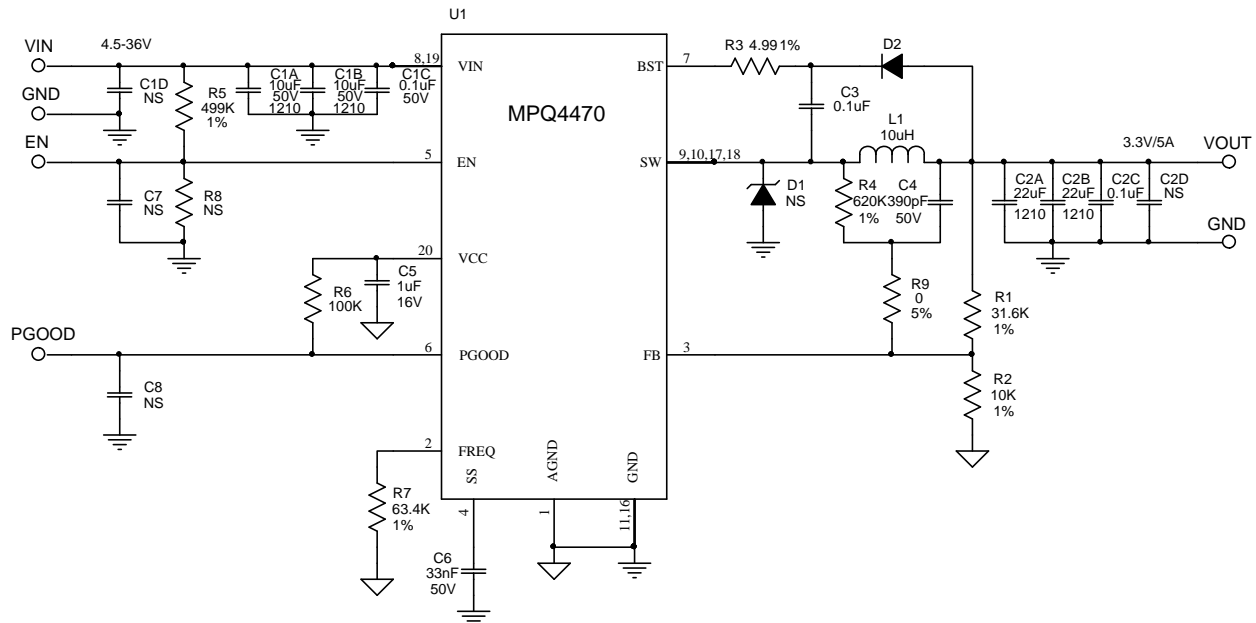

## EVQ4470-L-00A BILL OF MATERIALS

Qty	RefDes	Value	Description	Package	Manufacturer	Manufacturer_P/N
2	C1A,C1B	10 $\mu$ F	Ceramic Cap., 50V, X7R	1210	muRata	GRM32ER71H106KA12L
3	C1C,C2C, C3	0.1 $\mu$ F	Ceramic Cap., 50V, X7R	0402	TDK	C1005X7R1C104K
2	C2A,C2B	22 $\mu$ F	Ceramic Cap., 16V, X7R	1210	muRata	GRM32ER71C226KE79
1	C4	390pF	Ceramic Cap., 50V, C0G	0402	Yageo	CC0402KRX7R9BB391
1	C5	1 $\mu$ F	Ceramic Cap., 25V, X7R	0402	muRata	GRM155R61E105KA12
1	C6	33nF	Ceramic Cap., 16V, X7R	0402	Yageo	CC0402KRX7R7BB333
4	C1D,C2D, C7,C8	NS				
2	D1,D2	NS				
1	L1	10 $\mu$ H	Inductor, 21mOhm, 10.5A	SMD	Würth	7447709100
1	R1	31.6k	Film Res., 1%	0402	Yageo	RC0402FR-0731K6L
1	R2	10k	Film Res., 1%	0402	Yageo	RC0402FR-0710KL
1	R3	4.99 $\Omega$	Film Res., 1%	0402	Yageo	RC0402FR-074R99L
1	R4	620k	Film Res., 1%	0402	Yageo	RC0402FR-07620KL
1	R5	499k	Film Res., 1%	0402	Any	0402-F4993TCE
1	R6	100k	Film Res., 5%	0402	Any	0402-J0104TCE
1	R7	63.4k	Film Res., 1%	0402	Yageo	RC0402FR-0763K4L
1	R9	0 $\Omega$	Film Res., 5%	0402	Any	0402-J0000TCE
1	R8	NS				
1	U1	MPQ4470	Step-Down Regulator	QFN20-3x4	MPS	MPQ4470GL

## EVB TEST RESULTS

Performance waveforms are tested on the evaluation board.

$V_{IN} = 24V$ ,  $V_{OUT} = 3.3V$ ,  $T_A = 25^\circ C$ , unless otherwise noted.

**Efficiency vs. Load Current**

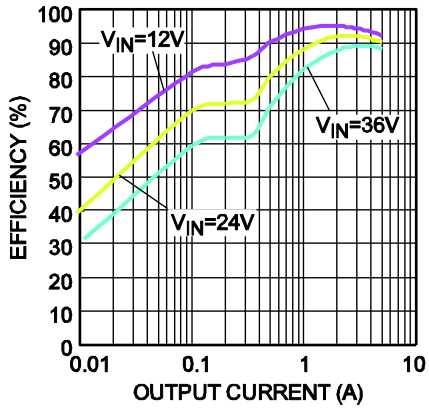

**Case Temperature Rise vs. Output Current**

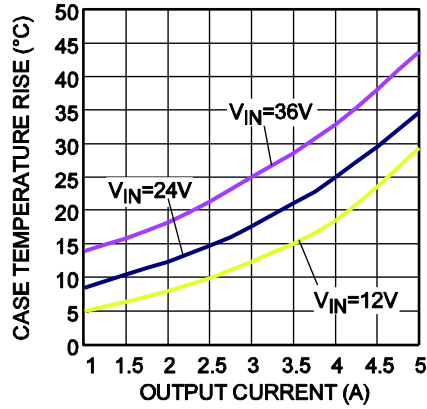

**$F_{sw}$  vs. Output Current**

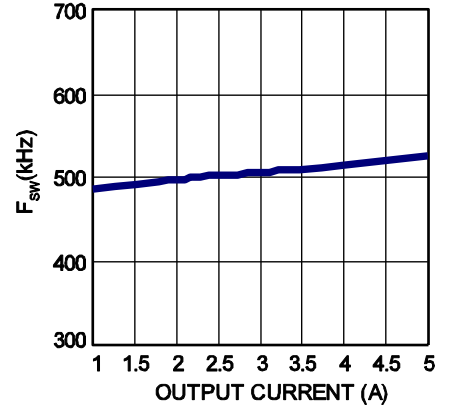

**$F_{sw}$  vs.  $V_{IN}$**

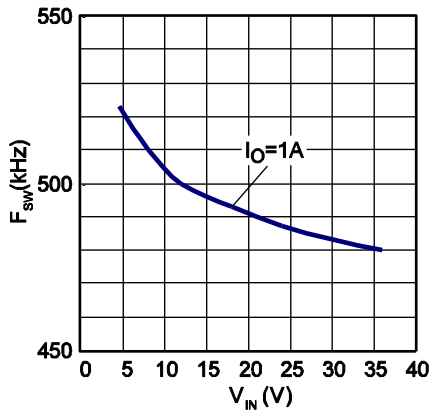

**Line Regulation**

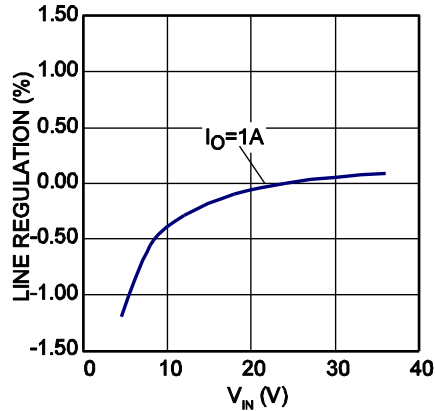

**Load Regulation**

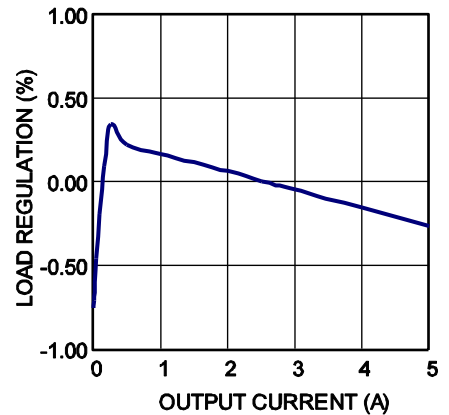

## EVB TEST RESULTS *(continued)*

Performance waveforms are tested on the evaluation board.

$V_{IN} = 24V$ ,  $V_{OUT} = 3.3V$ ,  $T_A = 25^\circ C$ , unless otherwise noted.

**Output Voltage Ripple**  
 $I_O = 0A$

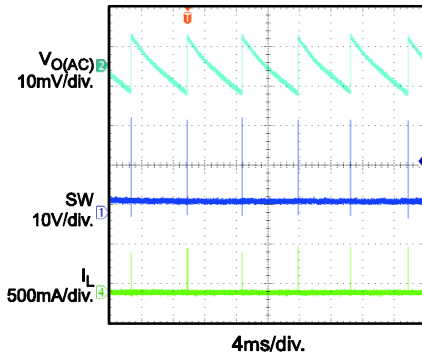

**Output Voltage Ripple**  
 $I_O = 5A$

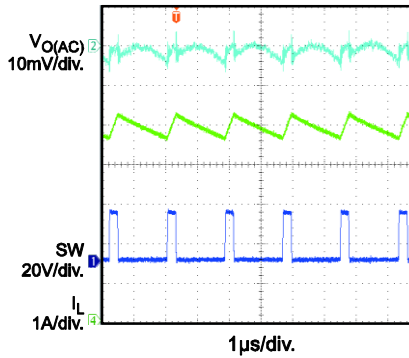

**Start-up Through  $V_{IN}$**   
 $I_O = 0A$

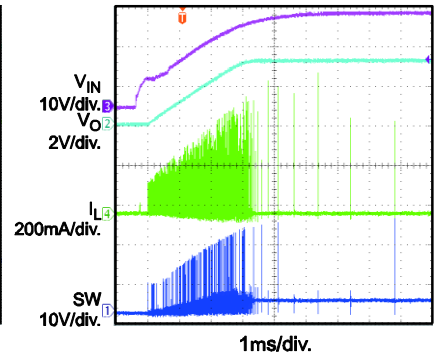

**Start-up Through  $V_{IN}$**   
 $I_O = 5A$

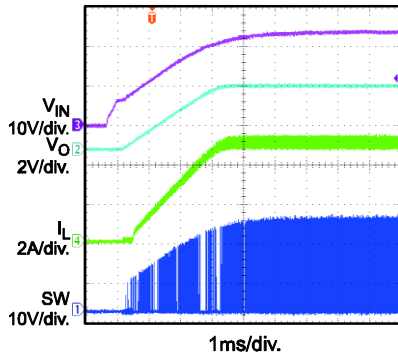

**Shutdown Through  $V_{IN}$**   
 $I_O = 0A$

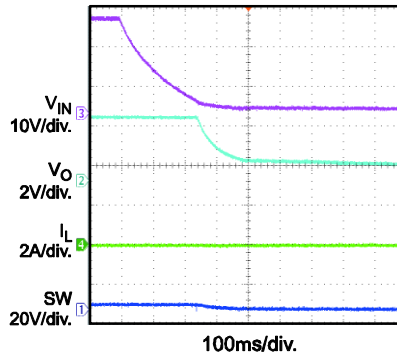

**Shutdown Through  $V_{IN}$**   
 $I_O = 5A$

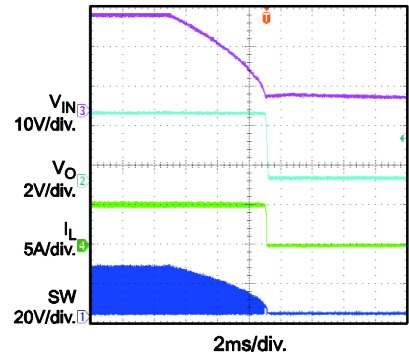

**Start-up Through EN**  
 $I_O = 0A$

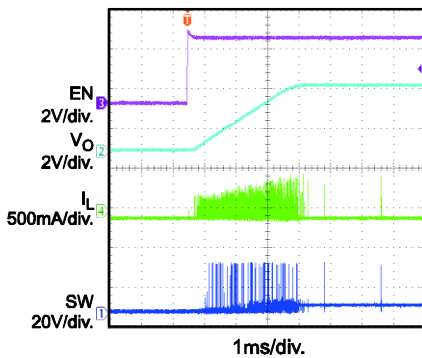

**Start-up Through EN**  
 $I_O = 5A$

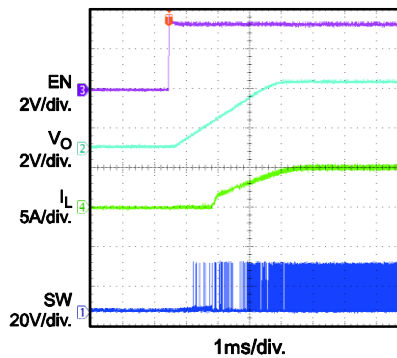

**Shutdown Through EN**  
 $I_O = 0A$

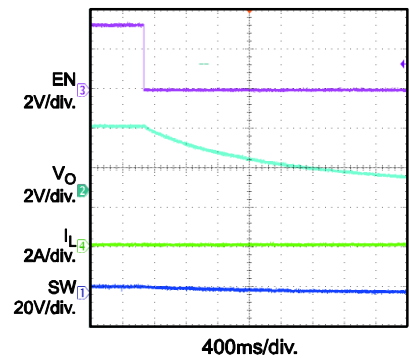

## EVB TEST RESULTS *(continued)*

Performance waveforms are tested on the evaluation board.

$V_{IN} = 24V$ ,  $V_{OUT} = 3.3V$ ,  $T_A = 25^\circ C$ , unless otherwise noted.

**Shutdown Through EN**  
 $I_O = 5A$

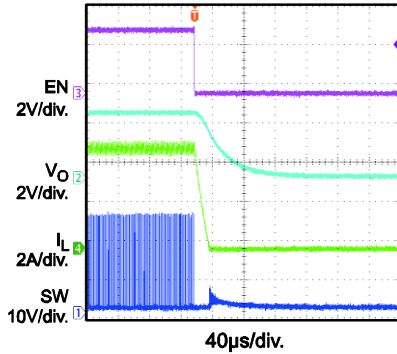

**Short Circuit Entry**  
 $I_O = 0A$

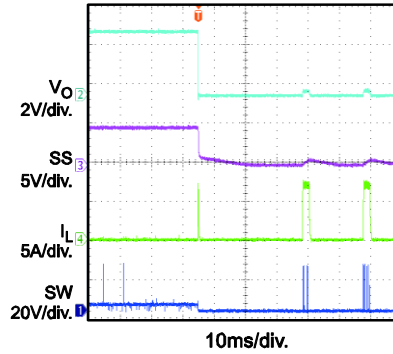

**Short Circuit Entry**  
 $I_O = 5A$

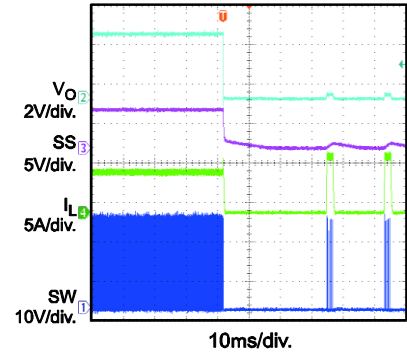

**Short Circuit Steady State**

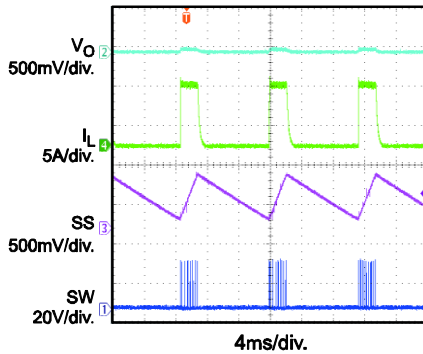

**Load Transient**  
 $I_O = 2.5A-5A@1.6A/\mu s$

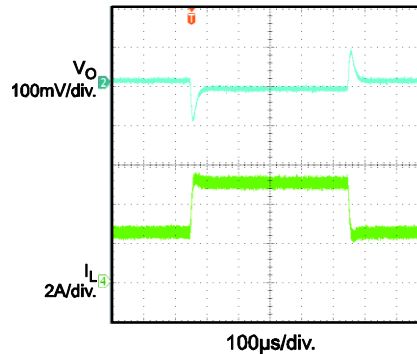

**Short Circuit Recovery**  
 $I_O = 0A$

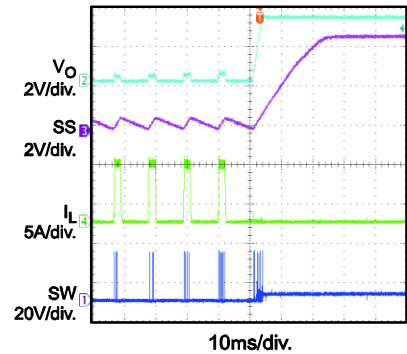

**Short Circuit Recovery**  
 $I_O = 5A$

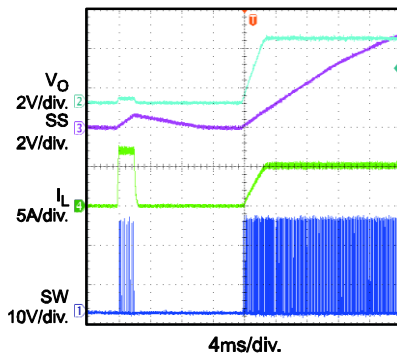

**Power Good Through EN Start-up**

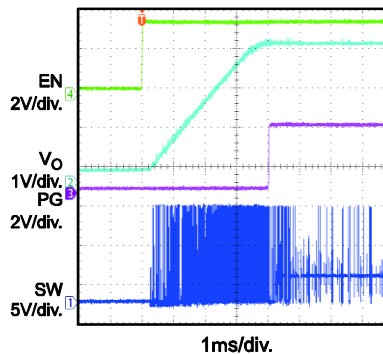

**Power Good Through EN Shutdown**

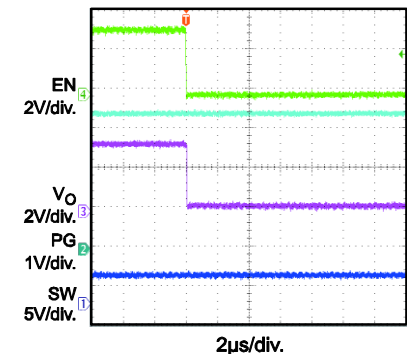

## PRINTED CIRCUIT BOARD LAYOUT

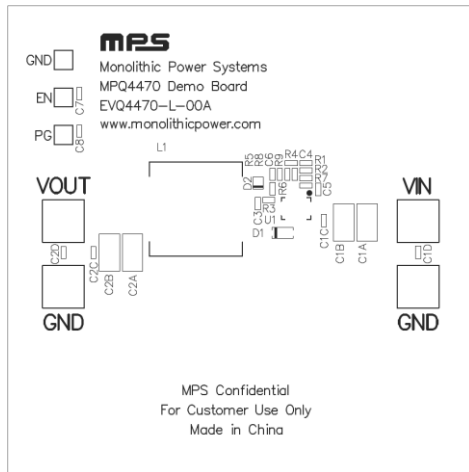

Figure 1—Top Silk Layer

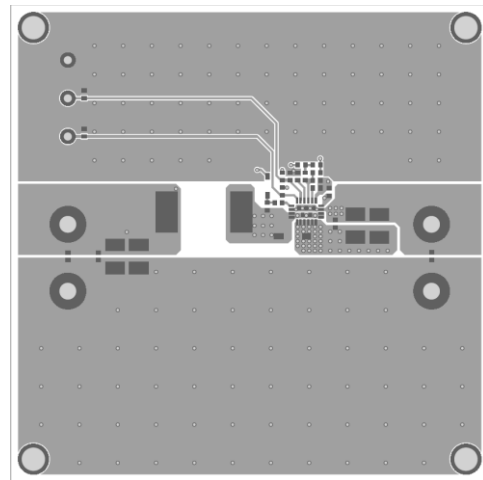

Figure 2—Top Layer

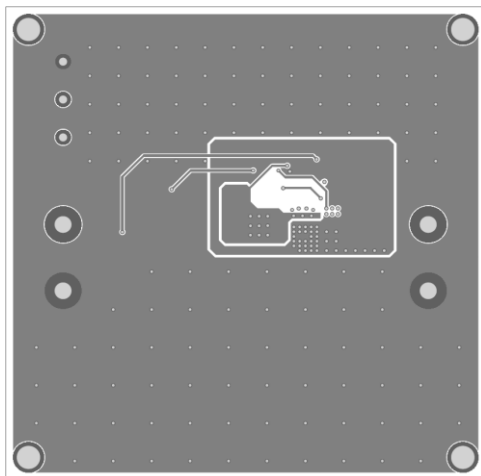

Figure 3—Inner1 Layer

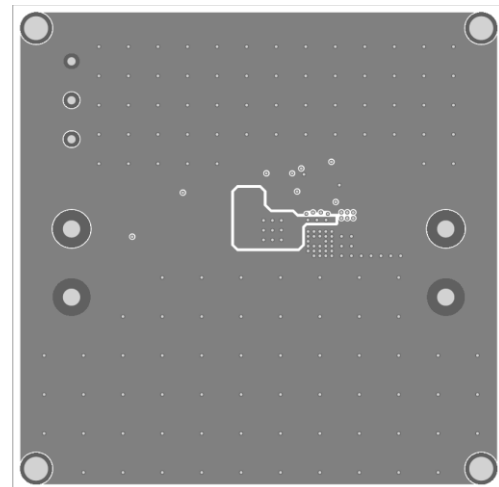

Figure 4—Inner2 Layer

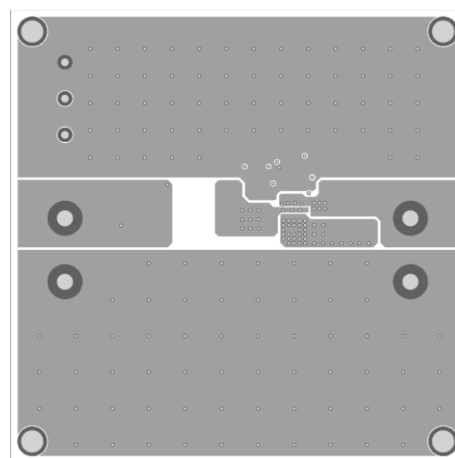

Figure 5—Bottom Layer

## QUICK START GUIDE

1. Connect the positive and negative terminals of the load to the VOUT and GND pins, respectively.
2. Preset the power supply output to between 4.5 and 36V, and then turn it off.
3. Connect the positive and negative terminals of the power supply output to the VIN and GND pins, respectively.
4. Turn the power supply on. The MPQ4470GL will automatically startup.
5. To use the Enable function, apply a digital input to the EN pin. Drive EN higher than 1.25V to turn on the regulator, drive EN less than 0.86V to turn it off.
6. An input under voltage lockout (UVLO) function is implemented by the addition of a resistor divider R5 and R8. The EN threshold is 0.86V (falling edge), so  $V_{IN}$  UVLO threshold is.  
$$0.86 \times \left(1 + \frac{R5}{R8}\right)$$
7. Use R1 and R2 to set the output voltage with  $V_{FB} = 0.815V$ . For  $R2 = 10k\Omega$ , R1 can be determined by:  $R1 = 12.27 \times (V_{OUT} - 0.815)$  (k $\Omega$ ). Follow the Application Information section in the device datasheet to recalculate the compensation, inductor and output capacitor values when output voltage is changed.

**NOTICE:** The information in this document is subject to change without notice. Users should warrant and guarantee that third party Intellectual Property rights are not infringed upon when integrating MPS products into any application. MPS will not assume any legal responsibility for any said applications.