



EVQ4491-RE-00A

2.5A, 36V, Frequency Selectable Step-Down Converter with Single USB Charging Port

DESCRIPTION

The EVQ4491-RE-00A Evaluation Board is designed to demonstrate the capabilities of MPS' MPQ4491. MPQ4491 integrates a monolithic step-down switch mode converter and one USB current limit switch with charging port identification circuit. It achieves 2.5A continuous output current over a wide input supply range with excellent load and line regulation.

The output of USB switch is current limited. MPQ4491 provides a USB Dedicate Charging Port (DCP) which supports Battery Charging Specification 1.2 (BC1.2), the Divider Mode, and 1.2V/1.2V Mode without the need of outside user interaction.

ELECTRICAL SPECIFICATION

Parameter	Symbol	Value	Units
Input Voltage	V_{IN}	7-36	V
Output Voltage	V_{USB}	5	V
Switching Frequency	F_s	250	kHz
Output Current	I_{USB}	2.5	A

FEATURES

- 14V Typical Operating Input Voltage
- 36V Max. Operating Input Voltage
- Fixed 5V Output Voltage with Line Drop Compensation
- Accurate Output Current Limit
- 350kHz/250kHz/150kHz Frequency Selectable
- Programmable Line Drop Compensation
- Supporting DCP schemes for BC1.2, Divider Mode, and 1.2V/1.2V Mode

APPLICATIONS

- USB Dedicated Charging Port (DCP)
- Automotive Cigarette Lighter Adapters
- Power Supply for Linear Chargers

All MPS parts are lead-free, halogen free, and adhere to the RoHS directive. For MPS green status, please visit MPS website under Quality Assurance. "MPS" and "The Future of Analog IC Technology" are Registered Trademarks of Monolithic Power Systems, Inc.

EVQ4491-RE-00A EVALUATION BOARD

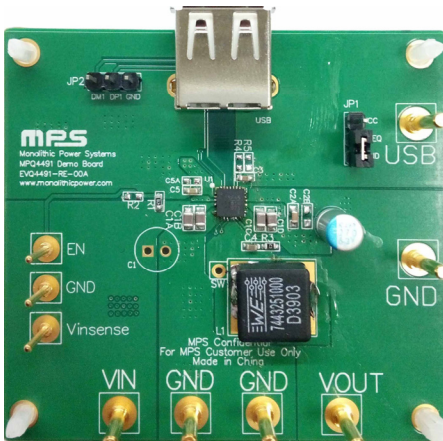

(L x W x H) 6.5cm x 6cm x 1.7cm

Board Number	MPS IC Number
EVQ4491-RE-00A	MPQ4491GRE-AEC1 (QFN-25)

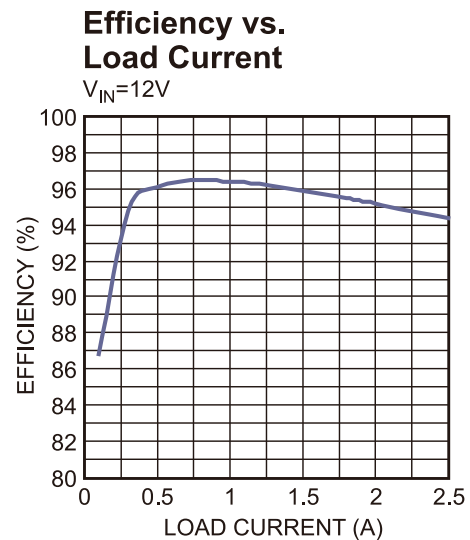

EVALUATION BOARD SCHEMATIC

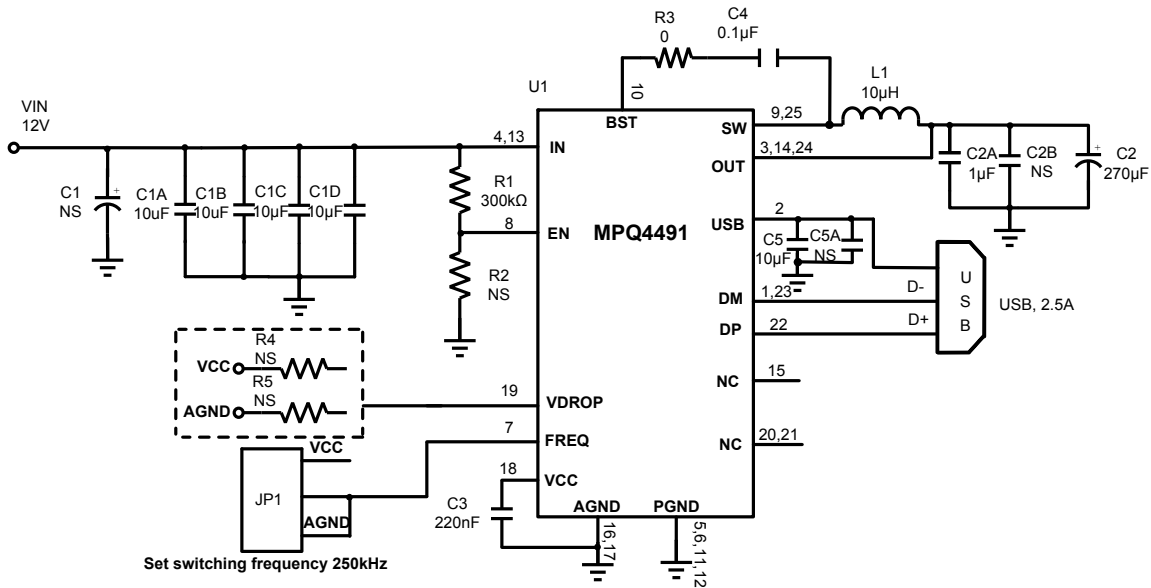

EVQ4491-RE-00A BILL OF MATERIALS

Qty	Ref	Value	Description	Package	Manufacturer	Part Number
0	C1, C5A	NS				
4	C1A, C1B, C1C, C1D	10 μ F	Ceramic Capacitor, 50V, X5R	0805	Murata	GRM21BR61H106KE43L
1	C2	270 μ F	Polymer Capacitor, 6.3V	DIP	Chemi-Con	APSK6R3ELL271ME08S
1	C2A	1 μ F	Ceramic Capacitor, 16V, X7R	0603	Murata	GRM188R71C105KA12D
1	C3	0.22 μ F	Ceramic Capacitor, 16V, X7R	0603	Murata	GRM188R71C224KA01D
1	C4	0.1 μ F	Ceramic Capacitor, 16V, X7R	0603	Murata	GRM188R71C104KA01D
1	C5	10 μ F	Ceramic Capacitor, 6.3V, X5R	0603	Murata	GRM188R60J106ME47D
1	R1	300k Ω	Resistor, 1%	0603	Royal	RL0603FR-07300KL
1	R3	0	Resistor, 1%	0603	Royal	RL0603FR-070KL
0	R2, R4, R5	NS				
1	L1	10 μ H	Inductor, DCR 16m Ω	SMT	Würth	7443251000
1	USB	USB	Single USB port	Tray	Würth	61400416021
1	JP1	Jumper	Jumper	DIP	Any	
1	U1	MPQ4491	Step Converter	QFN25 (4mmx4mm)	MPS	MPQ4491GRE-AEC1

TYPICAL PERFORMANCE CHARACTERISTICS

$V_{IN} = 12V$, $V_{OUT} = 5V$, $L = 10\mu H$, $f_s = 250kHz$, $T_A = 25^\circ C$, unless otherwise noted.

Line Drop Compensation vs. Load Current

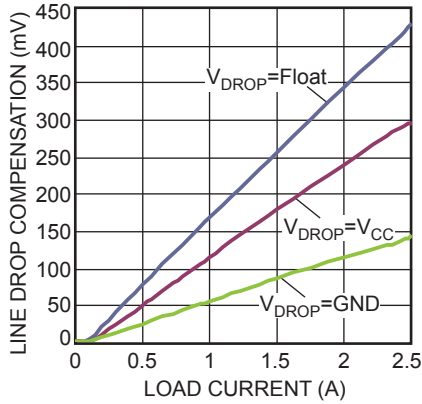

Efficiency vs. Load Current

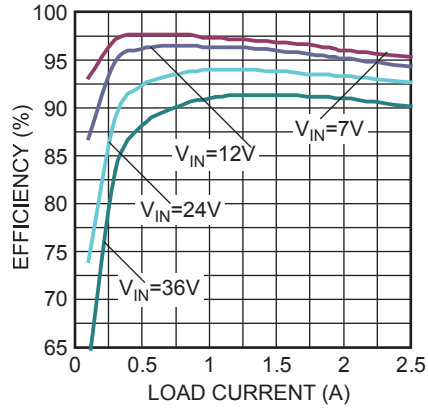

Thermal Test

$T_A = 25^\circ C$, No Airflow
 $V_{IN} = 12V$, $USB_I_{OUT} = 1.1A$

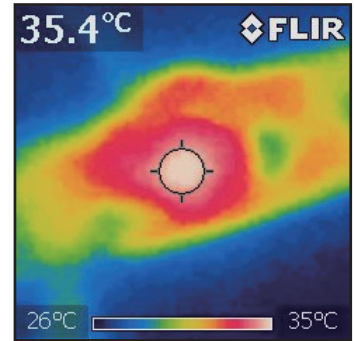

Thermal Test

$T_A = 25^\circ C$, No Airflow
 $V_{IN} = 12V$, $USB_I_{OUT} = 2.5A$

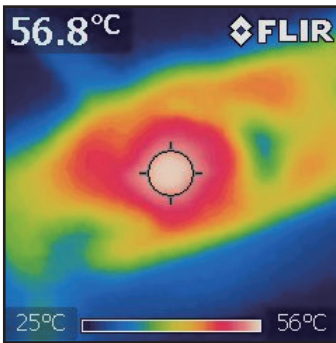

TYPICAL PERFORMANCE CHARACTERISTICS

$V_{IN} = 12V$, $V_{OUT} = 5V$, $L = 10\mu H$, $f_s = 250kHz$, $T_A = 25^\circ C$, unless otherwise noted.

Output Ripple

$V_{IN} = 12V$, $USB_I_{OUT} = 0A$

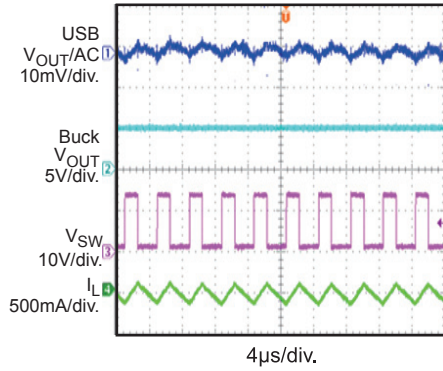

Output Ripple

$V_{IN} = 12V$, $USB_I_{OUT} = 2.5A$

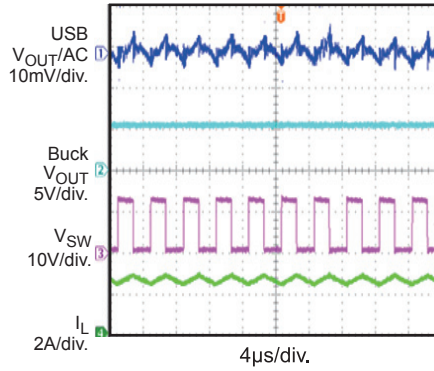

Power Start-Up

$V_{IN} = 12V$, $USB_I_{OUT} = 0A$

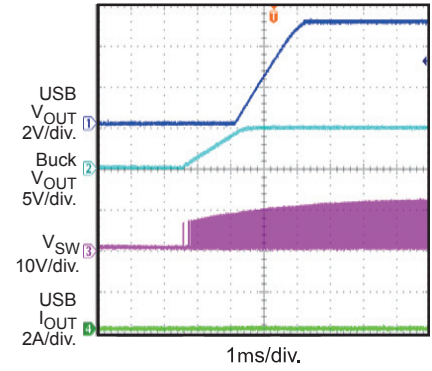

Power Start-Up

$V_{IN} = 12V$, $USB_I_{OUT} = 2.5A$,
CRL Load

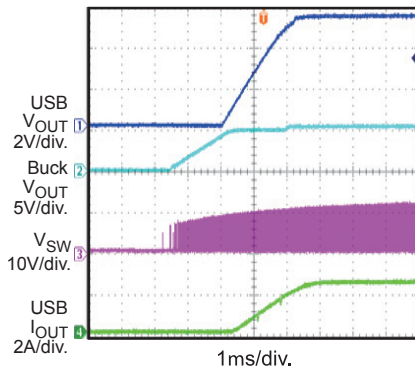

Power Shutdown

$V_{IN} = 12V$, $USB_I_{OUT} = 0A$

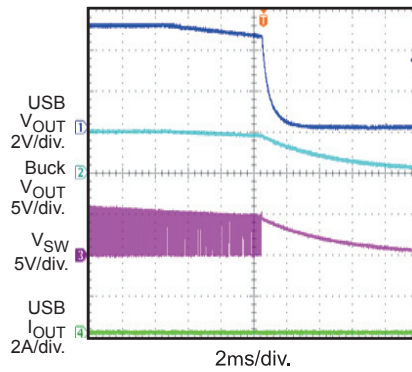

Power Shutdown

$V_{IN} = 12V$, $USB_I_{OUT} = 2.5A$,
CRL Load

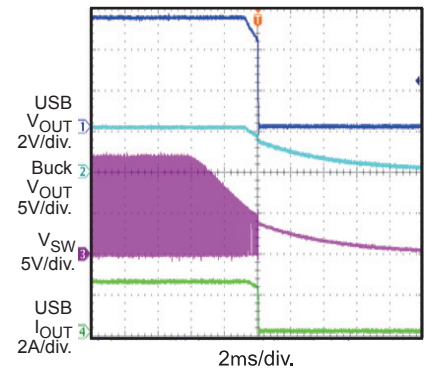

USB Over-Current Protection

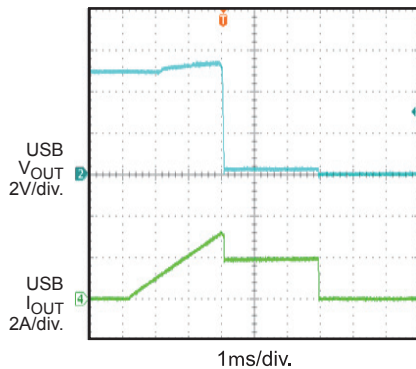

PRINTED CIRCUIT BOARD LAYOUT

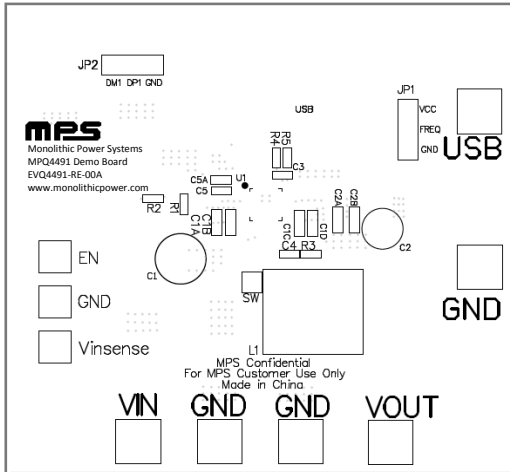

Figure 1—Top Silk Layer

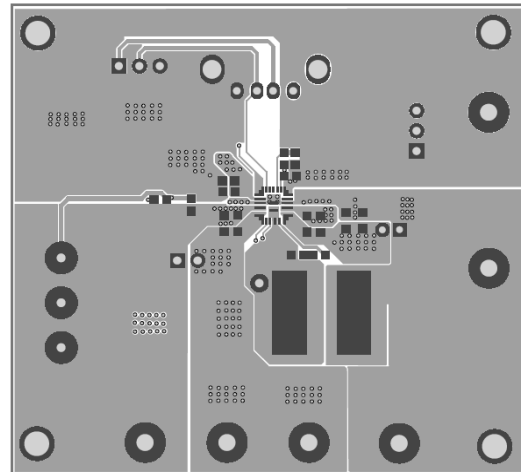

Figure 2—Top Layer

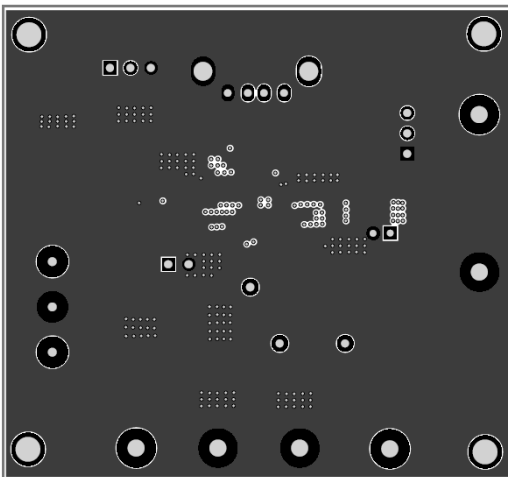

Figure 3—Mid 1 Layer

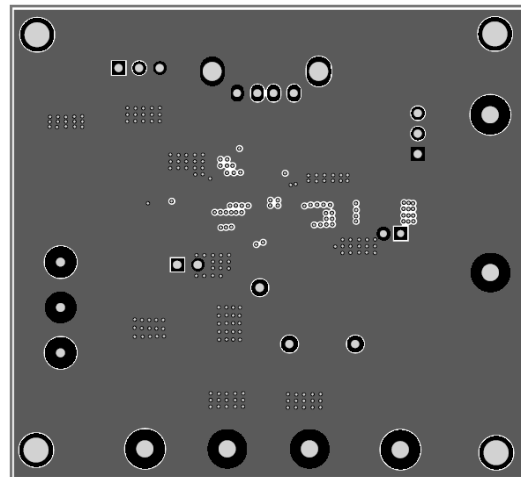

Figure 4—Mid 2 Layer

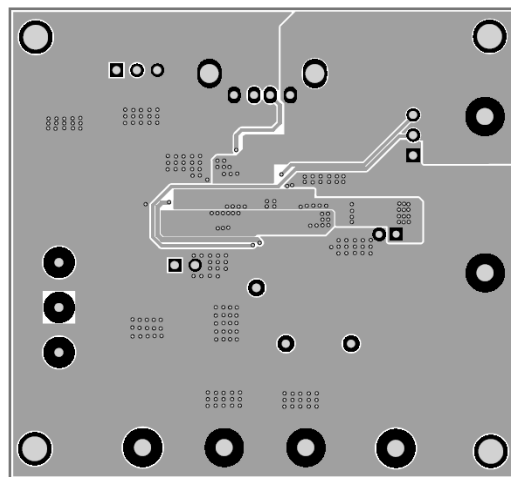

Figure 5—Bottom Layer

QUICK START GUIDE

1. Connect the positive and negative terminals of the load to the USB and GND pins, respectively.
2. Preset the power supply output between 7V and 36V, and then turn off the power supply.
3. Connect the positive and negative terminals of the power supply output to the VIN and GND pins, respectively.
4. Turn the power supply on. The board will automatically start up.
5. To use the Enable function, apply a digital input to the EN pin. Drive EN higher than 2V to turn on the regulator or less than 1V to turn it off.

NOTICE: The information in this document is subject to change without notice. Please contact MPS for current specifications. Users should warrant and guarantee that third party Intellectual Property rights are not infringed upon when integrating MPS products into any application. MPS will not assume any legal responsibility for any said applications.