

DESCRIPTION

The EVQ4559DN-00A is an evaluation board for the MPQ4559, a high frequency step-down regulator with an integrated power MOSFET.

The MPQ4559 integrates a 250mΩ MOSFET that provides 1.5A load current over a wide operating input voltage of 4.5V to 55V.

Current mode control provides fast transient response and eases loop stabilization. An internal soft-start prevents inrush current at turn-on.

The EVQ4559DN-00A is a fully assembled and tested PCB. It generates a +3.3V output voltage at load current up to 1.5A from an 8V to 55V input range. Switching frequency is set at 500kHz.

ELECTRICAL SPECIFICATIONS

Parameter	Symbol	Value	Units
Input Voltage	V_{IN}	8 – 55	V
Output Voltage	V_{OUT}	3.3	V
Output Current	I_{OUT}	1.5	A

FEATURES

- 1.5A Output Current
- Programmable Switching Frequency up to 2MHz
- Wide 8V to 55V Operating Input Range
- Adjustable Output from 0.8V
- Fully Assembled and Tested

APPLICATIONS

- High Voltage Power Conversion
- Game Machines
- Automotive Systems
- Industrial Power Systems
- Distributed Power Systems
- Printer Systems
- Battery Powered Systems

All MPS parts are lead-free and adhere to the RoHS directive. For MPS green status, please visit MPS website under Quality Assurance. "MPS" and "The Future of Analog IC Technology" are Registered Trademarks of Monolithic Power Systems, Inc.

EVQ4559DN-00A EVALUATION BOARD



(L x W x H) 2.5" x 2.5" x 0.4"
(6.35cm x 6.35cm x 1.0cm)

Board Number	MPS IC Number
EVQ4559DN-00A	MPQ4559DN

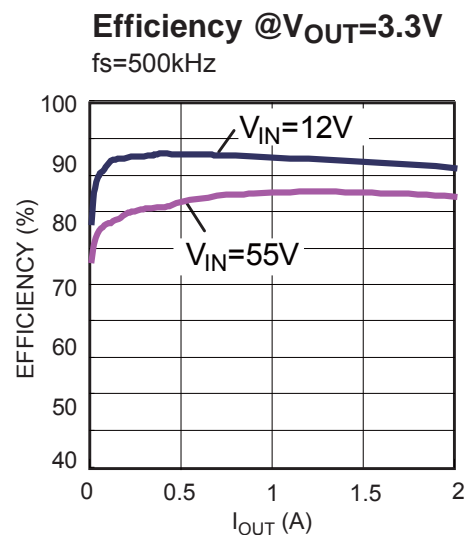

EVALUATION BOARD SCHEMATIC

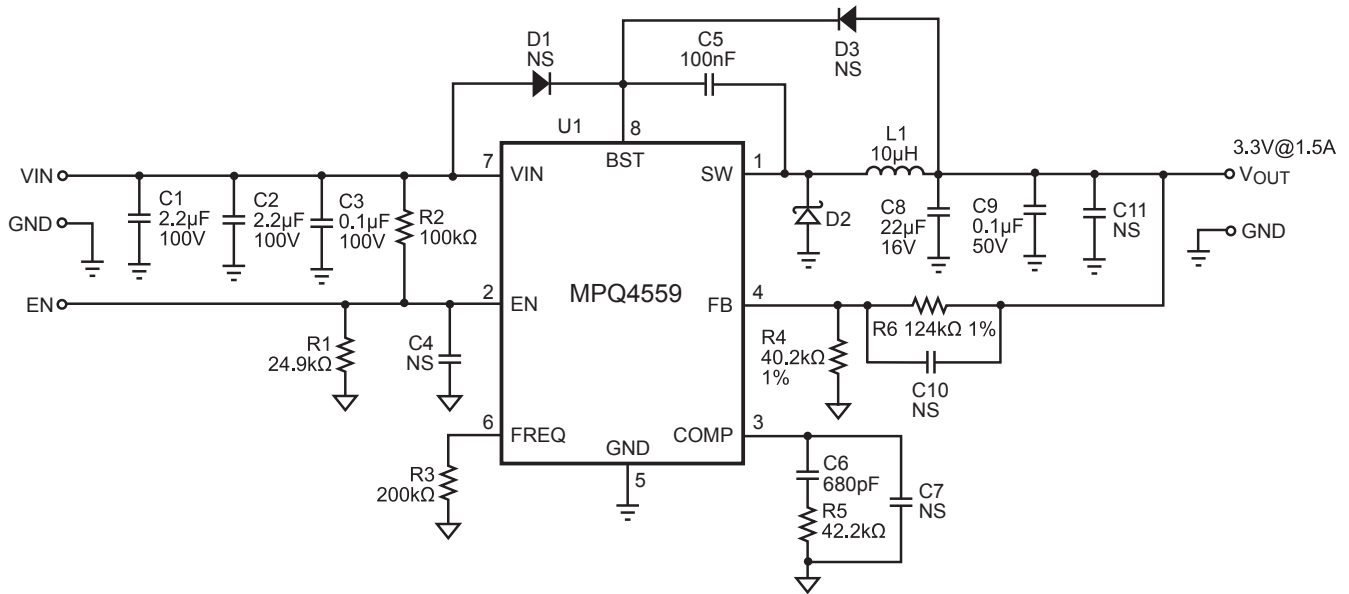

EVQ4559DN-00A BILL OF MATERIALS

Qty	Ref	Value	Description	Package	Manufacturer	Part Number
2	C1, C2	2.2 μ F	Ceramic Cap., 100V, X7R	1210	Murata	GRM32ER72A225KA35L
1	C3	0.1 μ F	Ceramic Cap., 100V, X7R	0805	TDK	C2012X7R2A104K
4	C4, C7, C10, C11		Not Stuffed			
1	C5	100nF	Ceramic Cap., 50V, X7R	0603	TDK	C1608X7R1H104K
1	C6	680pF	Ceramic Cap., 50V, X7R	0603	TDK	C1608X7R1H681K
1	C8	22 μ F	Ceramic Cap., 16V, X7R	1210	Murata	GRM32ER71C226ME18L
1	C9	0.1 μ F	Ceramic Cap., 50V, X7R	0805	TDK	C2012X7R1H104K
1	R1	24.9k Ω	Film Res., 1%	0603	Yageo	RC0603FR-0724K9L
1	R2	100k Ω	Film Res., 1%	0603	Yageo	RC0603FR-07100KL
1	R3	200k Ω	Film Res., 1%	0603	Yageo	RC0603FR-07200KL
1	R4	40.2k Ω	Film Res., 1%	0603	Yageo	RC0603FR-0740K2L
1	R5	42.2k Ω	Film Res., 1%	0603	Yageo	RC0603FR-0742K2L
1	R6	124k Ω	Film Res., 1%	0603	Yageo	RC0603FR-07124KL
2	D1, D3		Not Stuffed			
1	D2		Diode Schottky, 90V, 2A	SMB	Diodes Inc	B290-13-F
1	L1	10 μ H	Inductor, 4.3A	SMD	Toko	D104C-#919AS-100M
			Inductor, 4A	SMD	Cooper	SD8350-100-R
			Inductor, 3.6A	SMD	Würth	744066100
1	U1		Step-Down Regulator	SO8	MPS	MPQ4559DN

EVB TEST RESULTS

Performance waveforms are tested on the evaluation board.

$V_{IN} = 12V$, $V_{OUT} = 3.3V$, $C1 = 4.7\mu F$, $C2 = 22\mu F$, $L1 = 10\mu H$ and $T_A = +25^\circ C$, unless otherwise noted.

Efficiency @ $V_{OUT}=2.5V$
 $L1=10\mu H$, $f_s=500kHz$

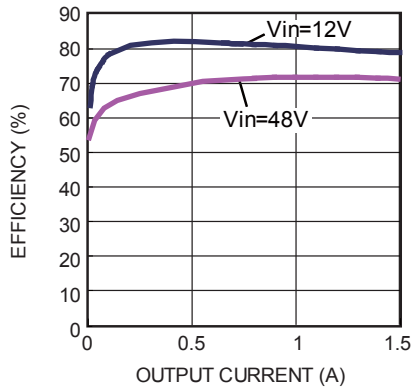

Efficiency @ $V_{OUT}=5V$
 $L1=15\mu H$, $f_s=500kHz$

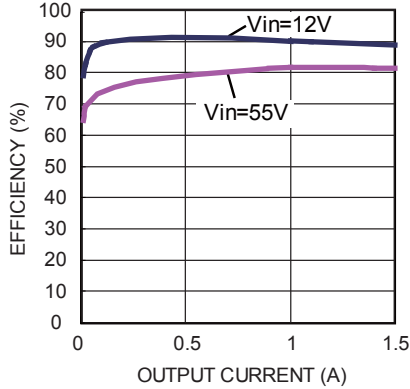

On Resistance vs. Junction Temperature

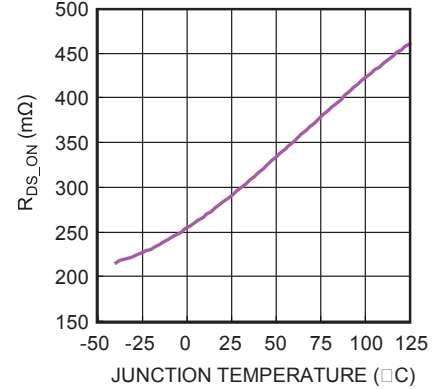

Voltage Reference vs. Junction Temperature

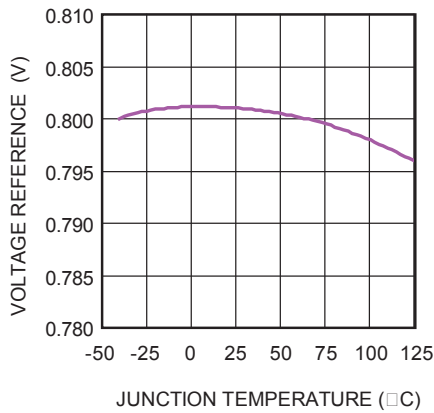

V_{IN} Start-up vs. Junction Temperature

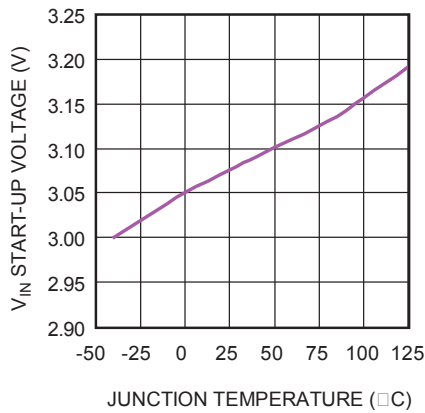

Frequency vs. Junction Temperature

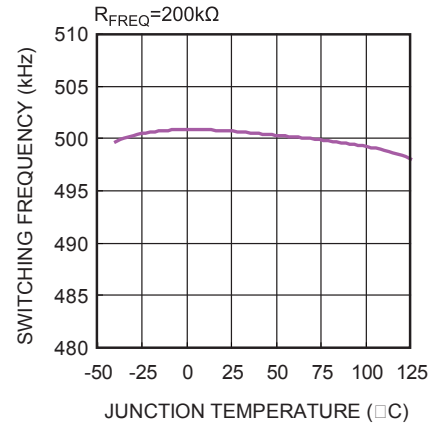

Output Voltage Ripple
 $I_{OUT}=0.1A$

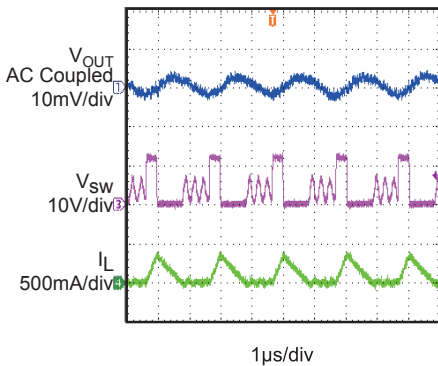

Output Voltage Ripple
 $I_{OUT}=1A$

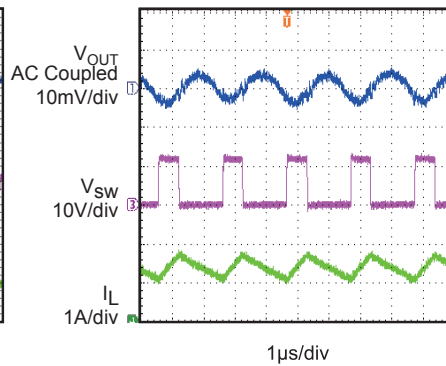

Output Voltage Ripple
 $I_{OUT}=1.5A$

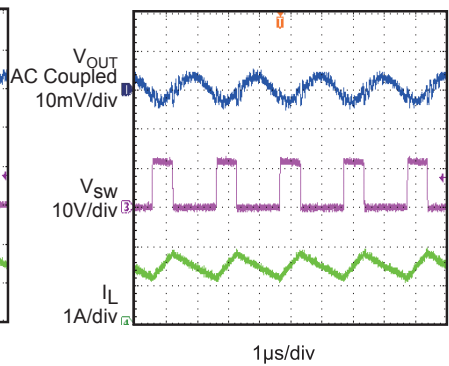

EVB TEST RESULTS *(continued)*

Performance waveforms are tested on the evaluation board.

$V_{IN} = 12V$, $V_{OUT} = 3.3V$, $C1 = 4.7\mu F$, $C2 = 22\mu F$, $L1 = 10\mu H$ and $T_A = +25^\circ C$, unless otherwise noted.

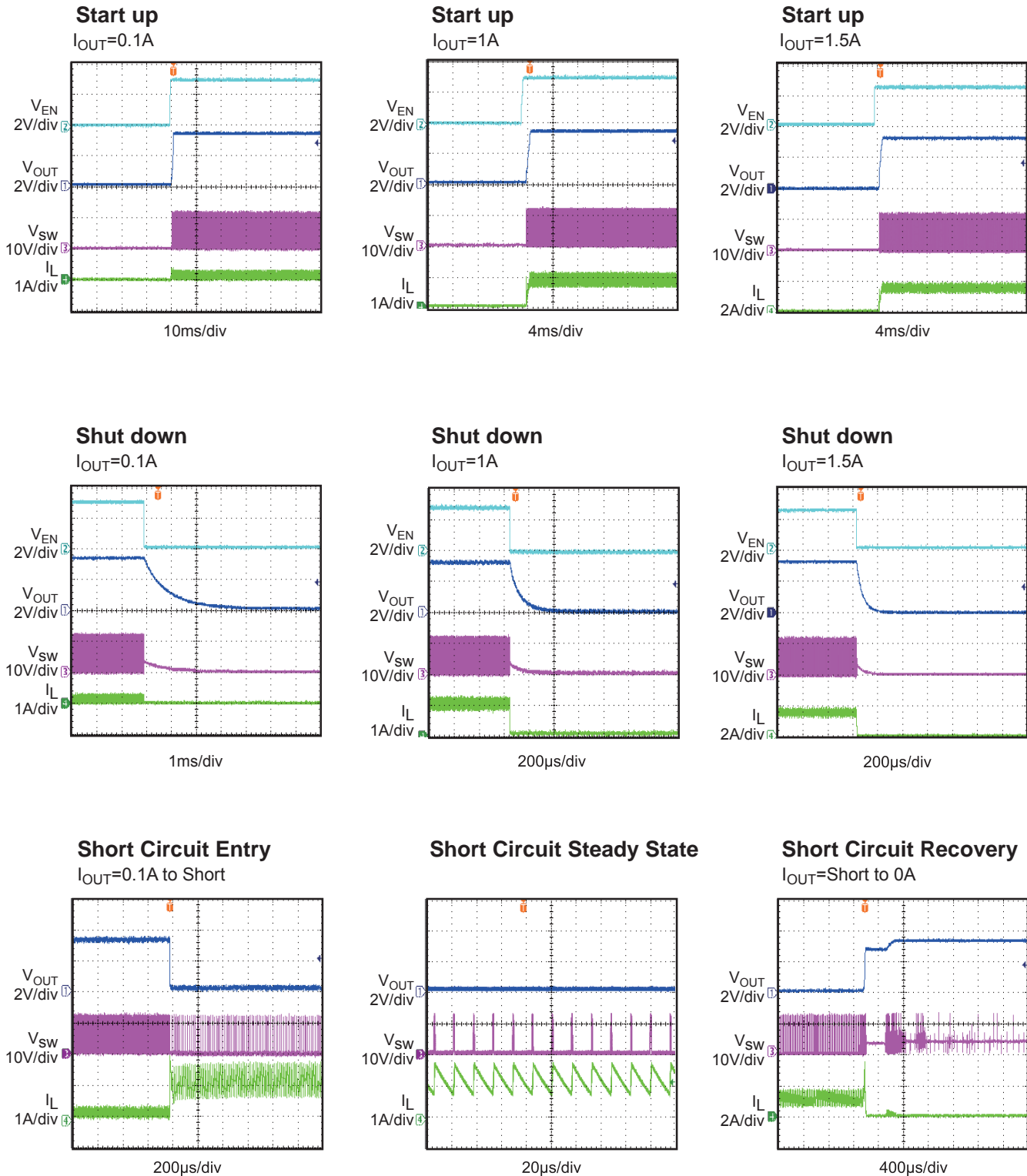

PRINTED CIRCUIT BOARD LAYOUT

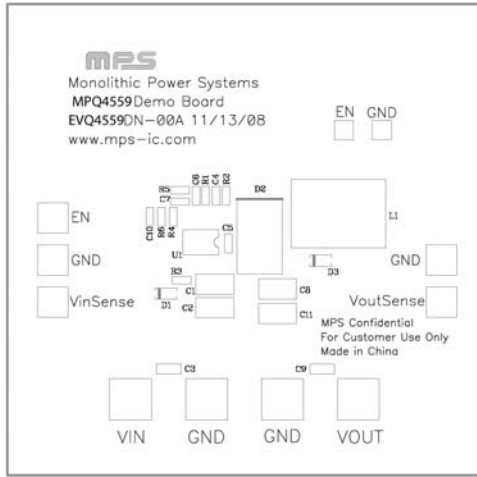

Figure 1—Top Silk Layer

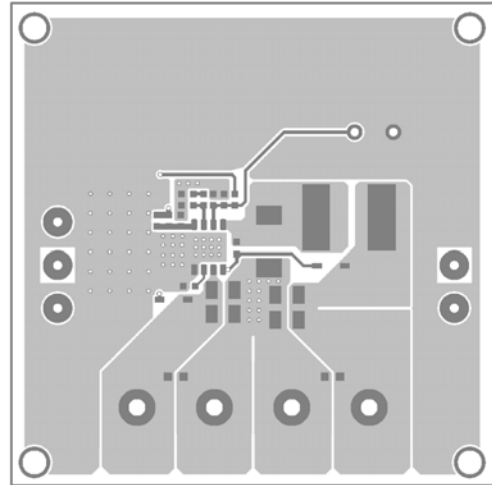

Figure 2—Top Layer

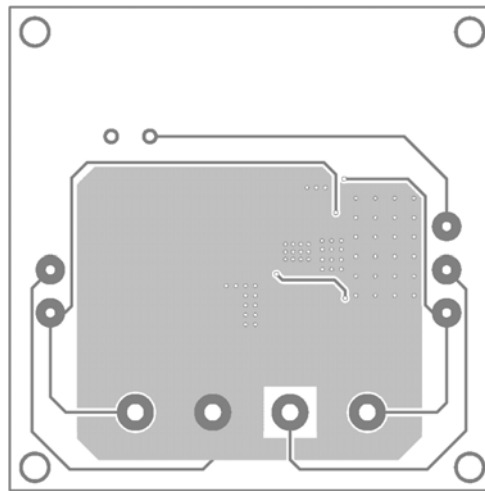

Figure 3—Bottom Layer

QUICK START GUIDE

1. Connect the positive and negative terminals of the load to the VOUT and GND pins, respectively.
2. Preset the power supply output to between 8 and 55V, and then turn it off.
3. Connect the positive and negative terminals of the power supply output to the VIN and GND pins, respectively.
4. Turn the power supply on. The EVQ4559DN will automatically startup.
5. To use the Enable function, apply a digital input to the EN pin. Drive EN higher than 1.8V to turn on the regulator, drive EN less than 1.2V to turn it off.
6. An input under voltage lockout (UVLO) function is implemented by the addition of a resistor divider R1 and R2. The EN threshold is 1.2V (falling edge), so V_{IN} UVLO threshold is $1.2V \times \left(1 + \frac{R2}{R1}\right)$. It is preset to 6V on this board.
7. Use R4 and R6 to set the output voltage with $V_{FB} = 0.8V$. For $R4 = 40.2k\Omega$, R6 can be determined by: $R6 = 50.25 \times (V_{OUT} - 0.8)(k\Omega)$. Follow the Application Information section in the device datasheet to recalculate the compensation, inductor and output capacitor values when output voltage is changed.

NOTICE: The information in this document is subject to change without notice. Users should warrant and guarantee that third party Intellectual Property rights are not infringed upon when integrating MPS products into any application. MPS will not assume any legal responsibility for any said applications.