



EVQ4572-QB-00A

60V, 2A, High-Efficiency, Synchronous Buck Converter Evaluation Board

DESCRIPTION

The EVQ4572-QB-00A evaluation board is designed to demonstrate the capabilities of the MPQ4572/MPQ4572-AEC1.

The MPQ4572/MPQ4572-AEC1 is a fully integrated, fixed-frequency, synchronous step-down converter. It can achieve up to 2A of continuous output current with peak current control for excellent transient response.

The MPQ4572/MPQ4572-AEC1 employs advanced asynchronous mode (AAM) which helps to achieve high efficiency under light-load conditions by scaling down the switching frequency to reduce the switching and gate driving losses.

The EVQ4572-QB-00A is a fully assembled and tested evaluation board. It generates a 5V output voltage and load currents up to 2A from a 5V to 60V input range.

ELECTRICAL SPECIFICATIONS

Parameter	Symbol	Value	Units
Input voltage	V_{EM1}	5 to 60	V
Output voltage	V_{OUT}	5	V
Output current	I_{OUT}	2	A

FEATURES

- Wide 5V to 60V Operating Input Range
- 2A Continuous Output Current
- High-Efficiency Synchronous Mode Control
- 250mΩ/45mΩ Internal Power MOSFETs
- Configurable Frequency Up to 2.2MHz
- 180° Out-of-Phase SYNCO Clock
- 40μA Quiescent Current
- Low Shutdown Mode Current: 2μA
- Selectable AAM or Forced CCM Operation under Light-Load Conditions
- Internal 0.45ms Soft Start
- Remote EN Control
- Power Good Indicator
- Low-Dropout Mode
- Over-Current Protection (OCP)
- Thermal Shutdown
- Available in a QFN-12 (2.5mmx3mm) Package
- Available in AEC-Q100 Grade 1

APPLICATIONS

- Automotive Systems
- Industrial Power Systems

All MPS parts are lead-free, halogen-free, and adhere to the RoHS directive. For MPS green status, please visit the MPS website under Quality Assurance. "MPS", the MPS logo, and "Simple, Easy Solutions" are trademarks of Monolithic Power Systems, Inc. or its subsidiaries.

EVQ4572-L-00A EVALUATION BOARD



(LxWxH) 8.3cmx8.3cmx1.3cm

Board Number	MPS IC Number
EVQ4572-QB-00A	MPQ4572GQB-AEC1

Efficiency vs. Load Current vs. Power Loss

$V_{OUT} = 5V$, $f_{SW} = 400kHz$, $L = 15\mu H$, AAM

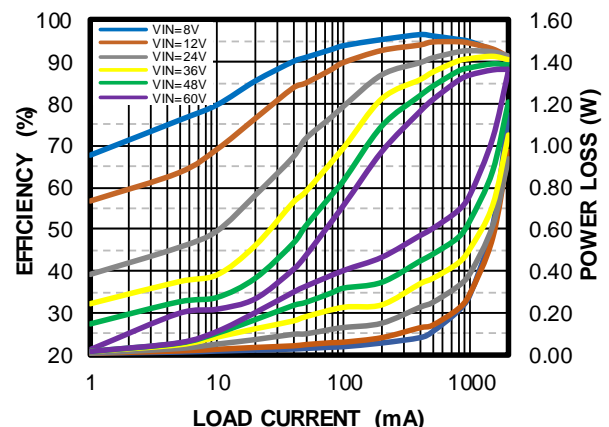

QUICK START GUIDE

1. Preset the power supply (V_{IN}) between to 5V and 60V.
Electronic loads represent a negative impedance to the regulator. If the current is too high, hiccup mode will be triggered.
2. Turn the power supply off.
If longer cables are used between the source and the EVB (>0.5m total), install a damping capacitor at the input terminals. This is especially critical when V_{IN} exceeds 24V.
3. Connect the power supply terminals to:
 - a) Positive (+): VEMI
 - b) Negative (-): GND
4. Connect the load to:
 - a) Positive (+): VOUT
 - b) Negative (-): GND
5. Turn the power supply on after making the connections.
6. To use the enable function, apply a digital input to the EN pin. Drive EN above 1.45V to turn the regulator on; drive EN below 1.12V to turn it off.
7. The oscillating frequency of the MPQ4572/MPQ4572-AEC1 can be configured with an external frequency resistor (R_{FREQ}). R_{FREQ} can be estimated with Equation (1):

$$R_{FREQ}(\text{M}\Omega) = \frac{30}{f_{sw}(\text{kHz})} \quad (1)$$

The calculated resistance may need fine-tuning via bench testing.

8. The output voltage is set by the external resistor divider. The feedback resistor ($R6 + R4$) also sets the feedback loop bandwidth with the internal compensation capacitor. Choose $R4$ to be around 40k Ω . Then $R5$ can be calculated with Equation (2):

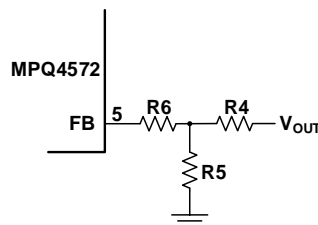

$$R5 = \frac{R4}{\frac{V_{OUT}}{0.8} - 1} \quad (2)$$

Table 1 lists the recommended feedback resistor values for common output voltages.

Table 1: Feedback Resistors for Output Voltages

V_{OUT} (V)	$R4$ (k Ω)	$R5$ (k Ω)	$R6$ (k Ω)
3.3	41.2 (1%)	13 (1%)	20 (1%)
5	41.2 (1%)	7.68 (1%)	20 (1%)
12	41.2 (1%)	2.94 (1%)	20 (1%)

9. JP3 and JP4 can be used to add external shielding above the inductor and IC. JP3 and JP4 are not stuffed by default.

EVALUATION BOARD SCHEMATIC

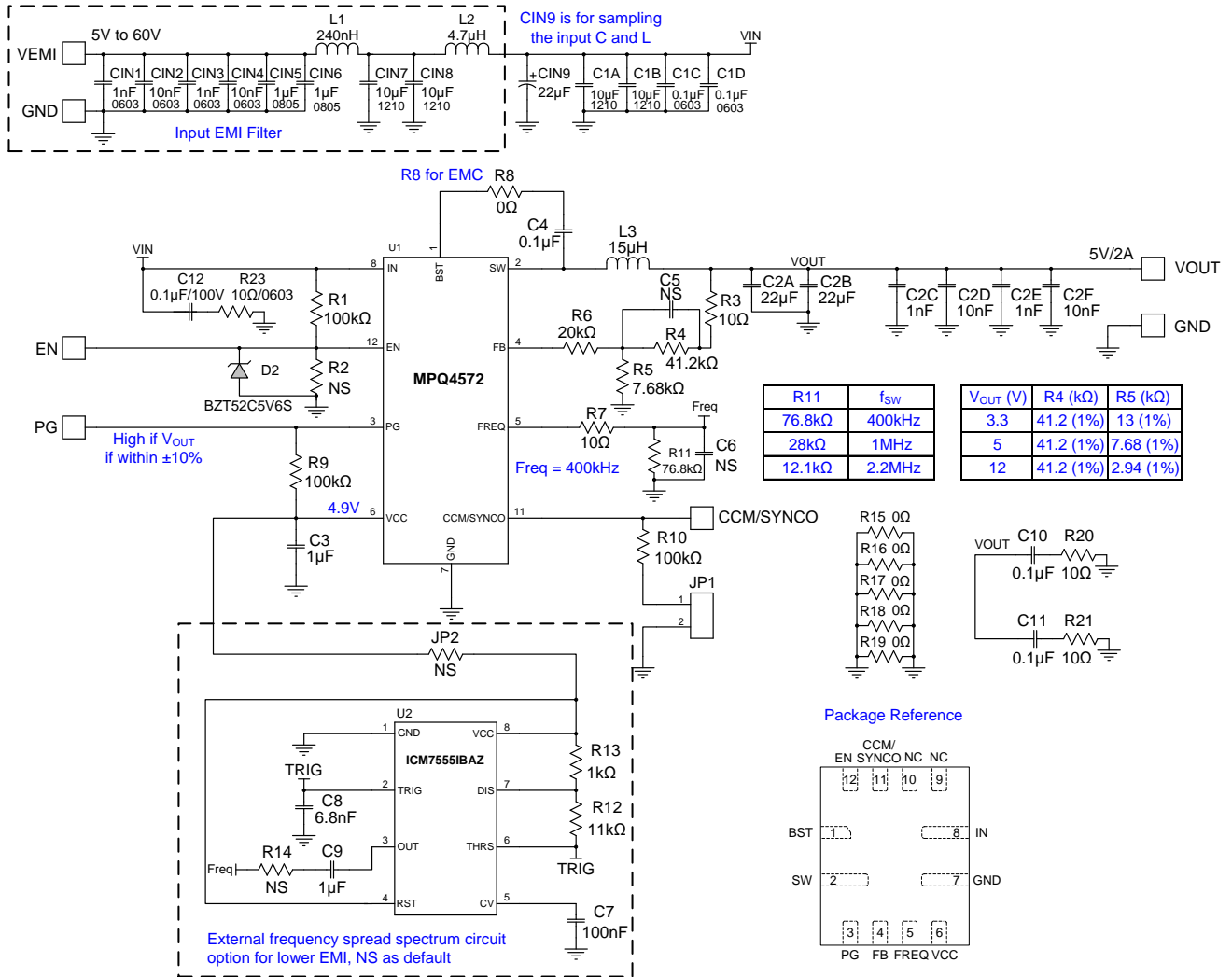

BILL OF MATERIALS

Qty	Designator	Value	Description	Package	Manufacturer	Manufacturer P/N
4	CIN1, C1N3, C2C, C2E	1nF	Ceramic capacitor, 100V, X7R	0603	muRata	GRM188R72A102KA01D
4	CIN2, CIN4, C2D, C2F	10nF	Ceramic capacitor, 100V, X7R	0603	muRata	GRM188R72A103KA01D
2	CIN5, CIN6	1μF	Ceramic capacitor, 100V, X7S	0805	muRata	GRM21BC72A105KE01L
4	CIN7, CIN8, C1A, C1B	10μF	Ceramic capacitor, 100V, X7S	1210	muRata	GRM32EC72A106KE05L
1	CIN9	22μF	Electrical capacitor, 63V, SMD	SMD	Jianghai	VTD-63V22
3	C1C, C1D, C12	0.1μF	Ceramic capacitor, 100V, X7R	0603	muRata	GRM188R72A104KA35D
2	C2A, C2B	22μF	Ceramic capacitor, 25V, X7R	1210	muRata	GRM32ER71E226KE15L
2	C3, C9	1μF	Ceramic capacitor, 25V, X7R	0603	muRata	GRM188R71E105KA12D
2	C4, C7	0.1μF	Ceramic capacitor, 16V, X7R	0603	muRata	GRM188R71C104KA01D
1	C8	6.8nF	Ceramic capacitor, 50V, X7R	0603	TDK	C1608X7R1H682K
2	C10, C11	0.1μF	Ceramic capacitor, 16V, X7R	0402	muRata	GRM155R71C104KA88D
2	C5, C6	NS				
1	L1	240nH	Inductor, 240nH, 19mΩ, 6.6A	SMD	TOKO	DFE201612E-R24M
1	L2	4.7μH	Inductor, 4.7uH, 83mΩ, 3.6A	SMD	TOKO	FDSD0402-H-4R7M
1	L3	15μH	Inductor, 15uH, 40mΩ, 5.8A	SMD	Coilcraft	XAL6060-153MEB
3	R1, R9, R10	100kΩ	Film resistor, 1%	0603	Yageo	RC0603FR-07100KL
3	R2, JP2, R14	NS				
3	R3, R7, R23	10	Film resistor, 1%	0603	Yageo	RC0603FR-0710RL

BILL OF MATERIALS (continued)

Qty	Designator	Value	Description	Package	Manufacturer	Manufacturer P/N
1	R4	41.2kΩ	Film resistor, 1%	0603	Yageo	RC0603FR-0741K2L
1	R5	7.68kΩ	Film resistor, 1%	0603	Yageo	RC0603FR-077K68L
1	R6	20kΩ	Film resistor, 1%	0603	Yageo	RC0603FR-0720KL
1	R8	0	Film resistor, 1%	0603	Yageo	RC0603FR-070RL
1	R11	76.8kΩ	Film resistor, 1%	0603	Yageo	RC0603FR-0776K8L
1	R12	11kΩ	Film resistor, 1%	0603	Yageo	RC0603FR-0711KL
1	R13	1kΩ	Film resistor, 1%	0603	Yageo	RC0603FR-071KL
5	R15, R16, R17, R18, R19	0	Film resistor, 1%	0402	Yageo	RC0402FR-070RL
2	R20, R21	10	Film resistor, 1%	0402	Yageo	RC0402FR-0710RL
1	D2		Zener diode, 5.6V	SOD323	Diodes	BZT52C5V6S
1	U1		Step-down regulator	QFN-12 (2.5mmx3.0mm)	MPS	MPQ4572GQB-AEC1
1	U2			SOP-8	Intersil	ICM7555IBAZ
1	JP1		2.54mm test pin		HZ	
4	VEMI, GND, GND, VOUT		2.0 golden pin		HZ	
2	JP3, JP4	NS				

EVB TEST RESULTS

Performance curves and waveforms are tested on the evaluation board. $V_{IN} = 24V$, $V_{OUT} = 5V$, $L = 15\mu H$, $f_{SW} = 400kHz$, $T_A = 25^\circ C$, unless otherwise noted.

Efficiency vs. Load Current vs. Power Loss

$V_{OUT} = 5V$, $f_{SW} = 400kHz$, $L = 15\mu H$, AAM

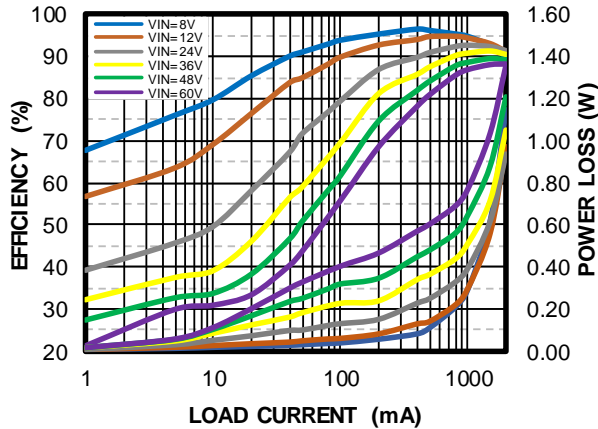

Efficiency vs. Load Current vs. Power Loss

$V_{OUT} = 5V$, $f_{SW} = 400kHz$, $L = 15\mu H$, CCM

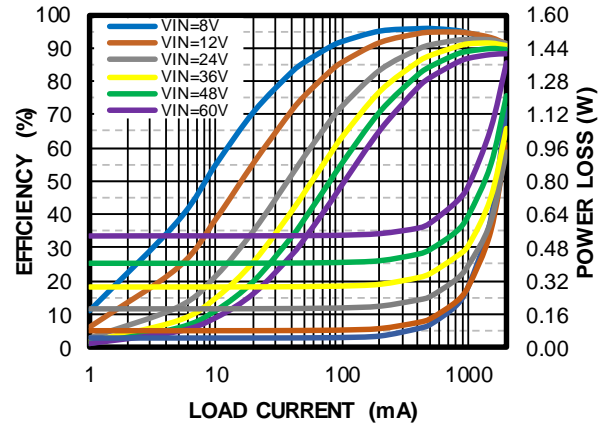

Efficiency vs. Load Current vs. Power Loss

$V_{OUT} = 5V$, $f_{SW} = 1MHz$, $L = 10\mu H$, AAM

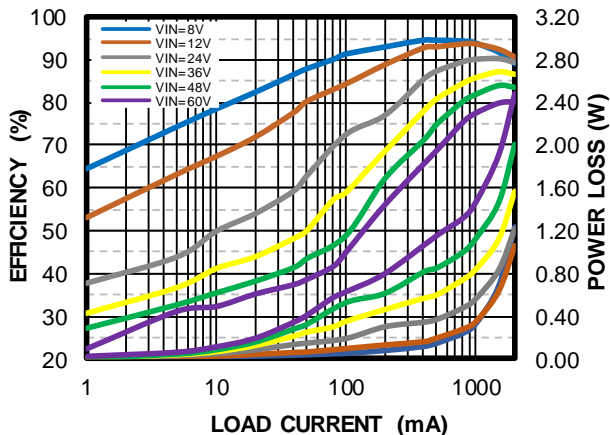

Efficiency vs. Load Current vs. Power Loss

$V_{OUT} = 5V$, $f_{SW} = 1MHz$, $L = 10\mu H$, CCM

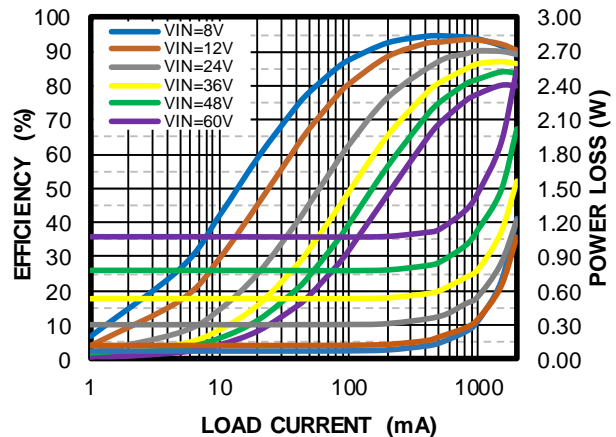

Efficiency vs. Load Current vs. Power Loss

$V_{OUT} = 5V$, $f_{SW} = 2.2MHz$, $L = 4.7\mu H$, AAM

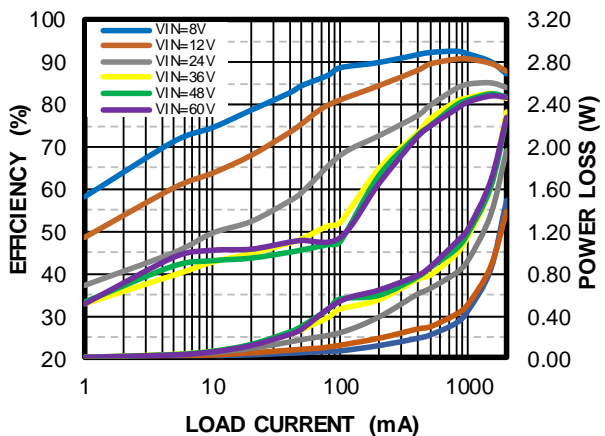

Efficiency vs. Load Current vs. Power Loss

$V_{OUT} = 5V$, $f_{SW} = 2.2MHz$, $L = 4.7\mu H$, CCM

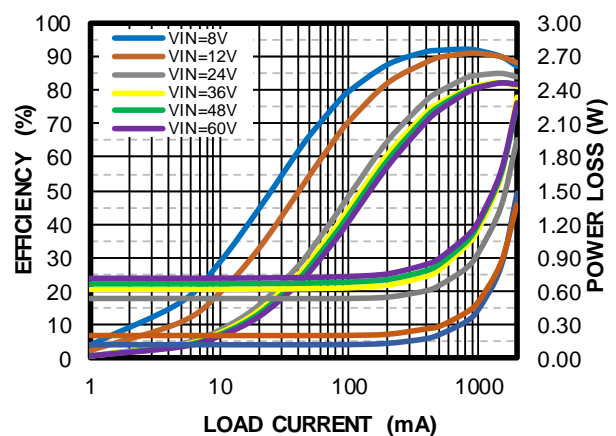

EVB TEST RESULTS (continued)

Performance curves and waveforms are tested on the evaluation board. $V_{IN} = 24V$, $V_{OUT} = 5V$, $L = 15\mu H$, $f_{SW} = 400kHz$, $T_A = 25^\circ C$, unless otherwise noted.

Start-Up through Input Voltage
 $I_{OUT} = 0A$, AAM

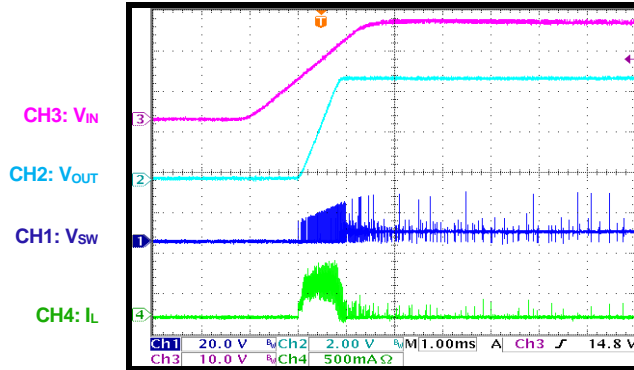

Start-Up through Input Voltage
 $I_{OUT} = 0A$, CCM

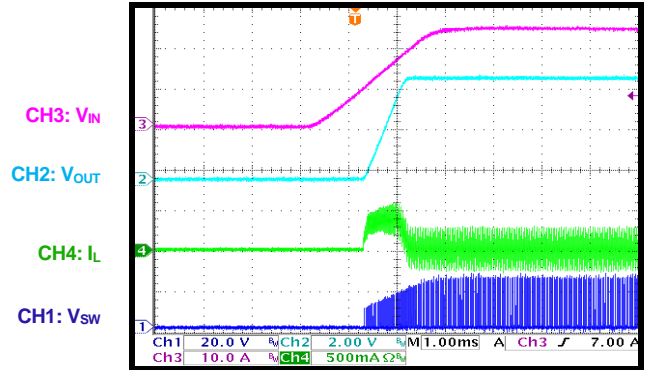

Start-Up through Input Voltage
 $I_{OUT} = 2A$

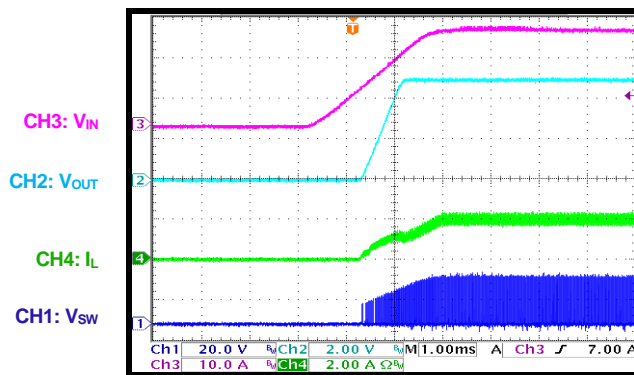

Shutdown through Input Voltage
 $I_{OUT} = 0A$, AAM

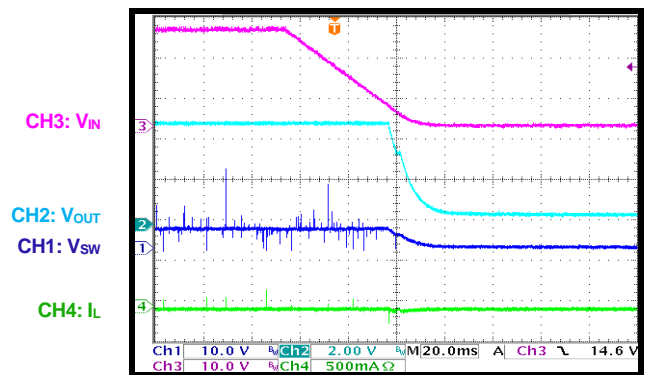

Shutdown through Input Voltage
 $I_{OUT} = 0A$, CCM

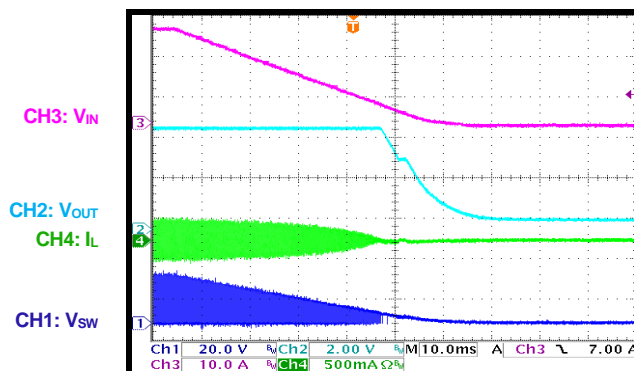

Shutdown through Input Voltage
 $I_{OUT} = 2A$

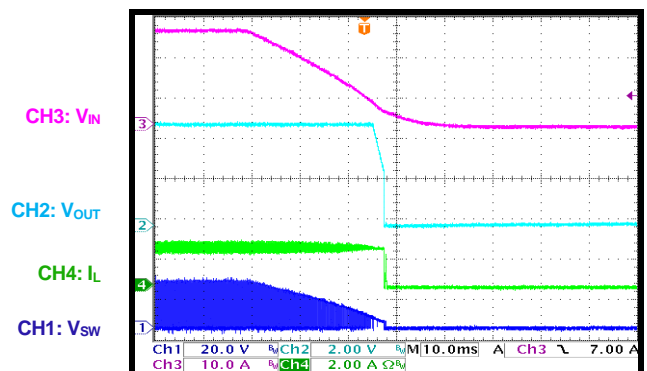

EVB TEST RESULTS (continued)

Performance curves and waveforms are tested on the evaluation board. $V_{IN} = 24V$, $V_{OUT} = 5V$, $L = 15\mu H$, $f_{SW} = 400kHz$, $T_A = 25^\circ C$, unless otherwise noted.

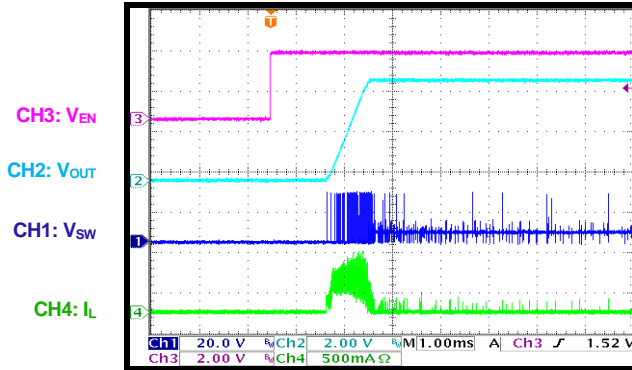
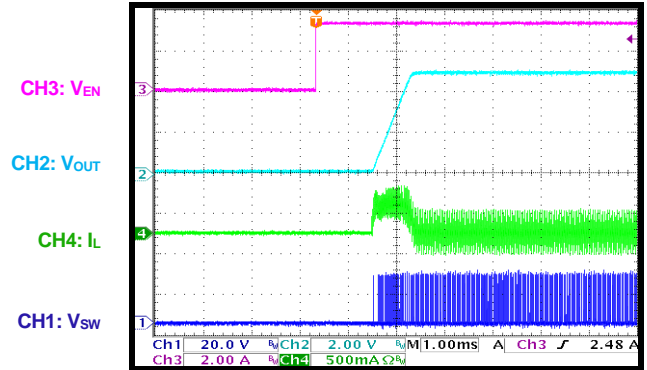
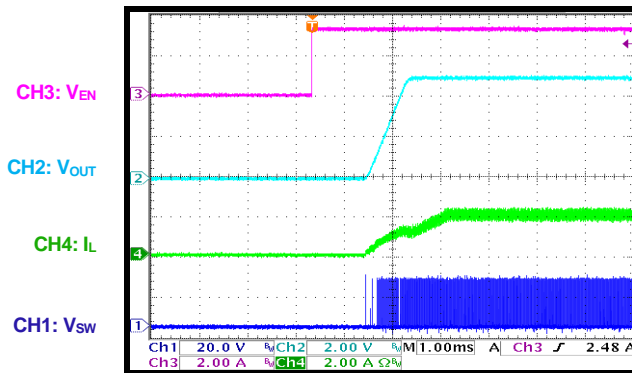
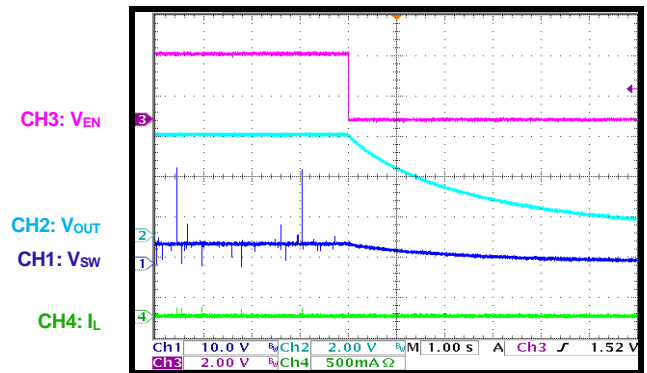
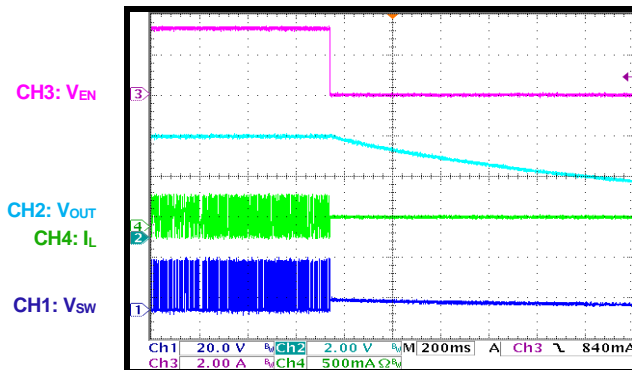
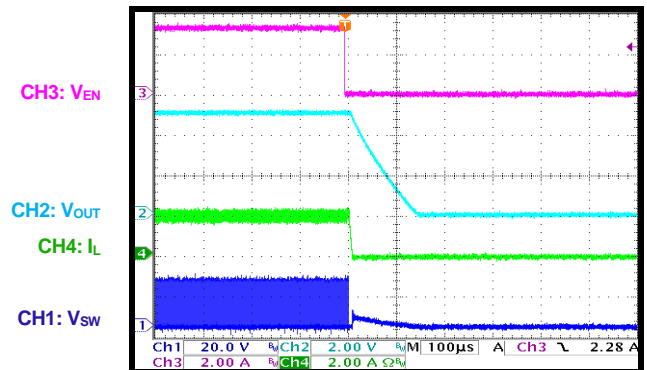
Start-Up through EN
 $I_{OUT} = 0A$, AAM

Start-Up through EN
 $I_{OUT} = 0A$, CCM

Start-Up through EN
 $I_{OUT} = 2A$

Shutdown through EN
 $I_{OUT} = 0A$, AAM

Shutdown through EN
 $I_{OUT} = 0A$, CCM

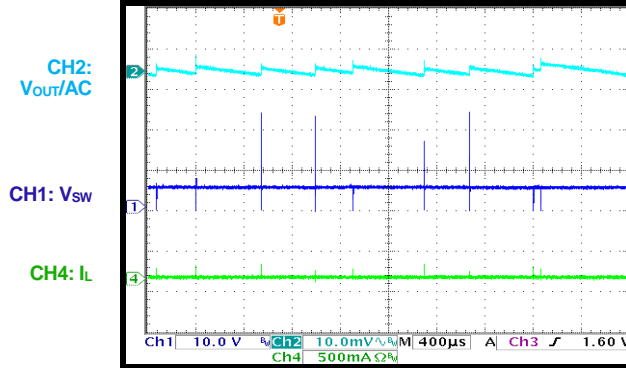
Shutdown through EN
 $I_{OUT} = 2A$

EVB TEST RESULTS (continued)

Performance curves and waveforms are tested on the evaluation board. $V_{IN} = 24V$, $V_{OUT} = 5V$, $L = 15\mu H$, $f_{SW} = 400kHz$, $T_A = 25^\circ C$, unless otherwise noted.

Output Ripple

$I_{OUT} = 0A$, AAM



Output Ripple

$I_{OUT} = 0A$, CCM

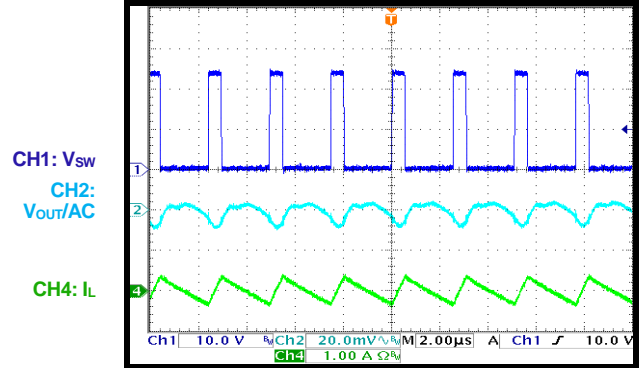

Output Ripple

$I_{OUT} = 2A$

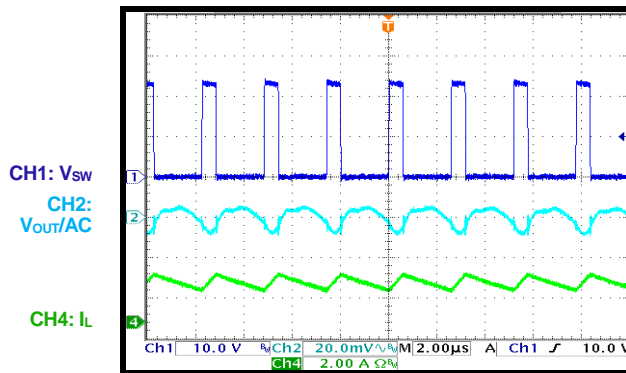

SCP Entry

$I_{OUT} = 0A$, AAM

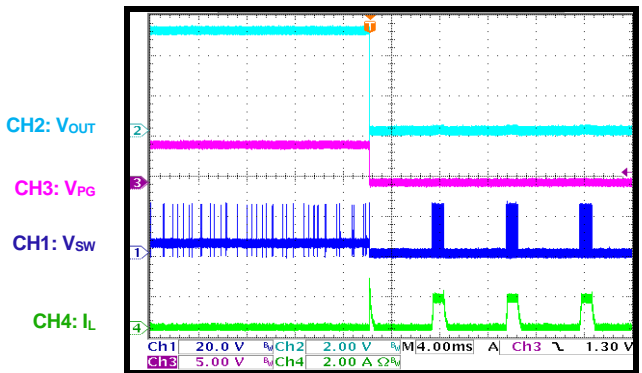

SCP Entry

$I_{OUT} = 0A$, CCM

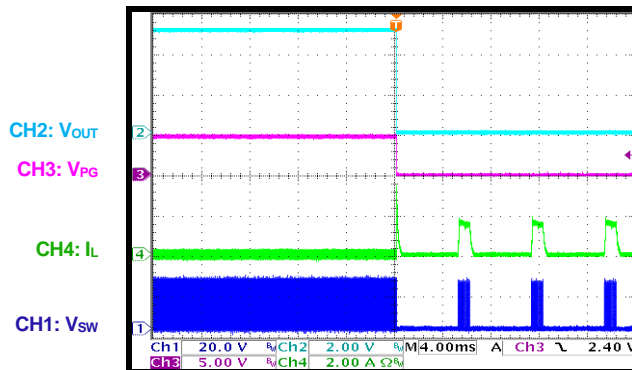

SCP Entry

$I_{OUT} = 2A$

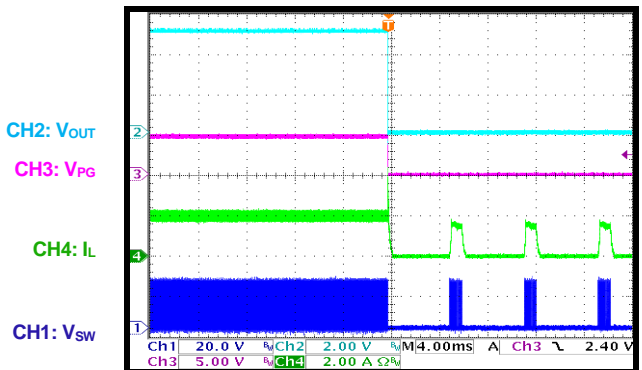

EVB TEST RESULTS (continued)

Performance curves and waveforms are tested on the evaluation board. $V_{IN} = 24V$, $V_{OUT} = 5V$, $L = 15\mu H$, $f_{SW} = 400kHz$, $T_A = 25^\circ C$, unless otherwise noted.

SCP Recovery

$I_{OUT} = 0A$, AAM

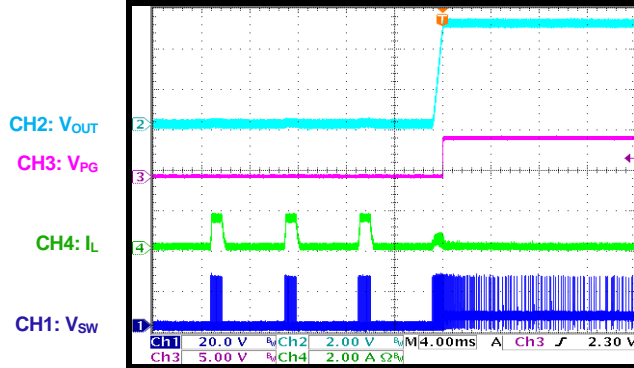

SCP Recovery

$I_{OUT} = 0A$, CCM

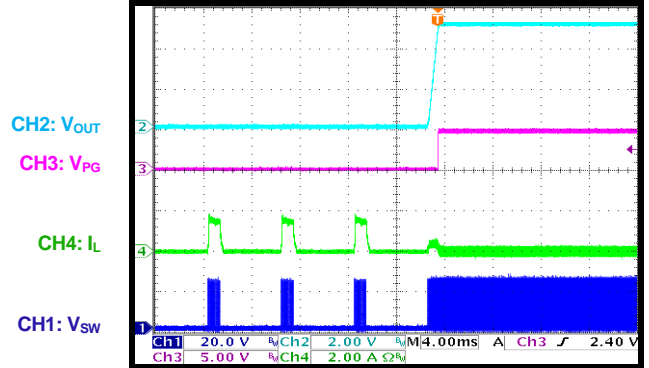

SCP Recovery

$I_{OUT} = 2A$

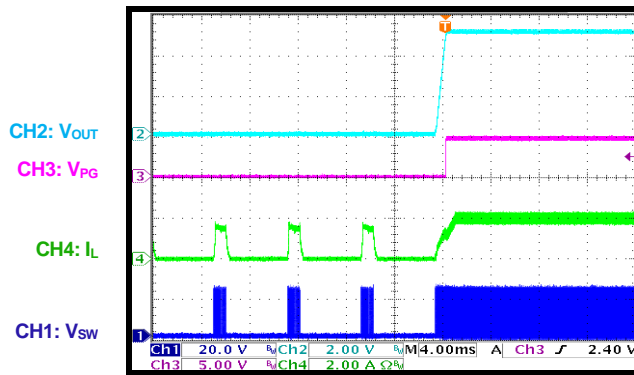

Load Transient

$I_{OUT} = 0A$ to $1A$, AAM

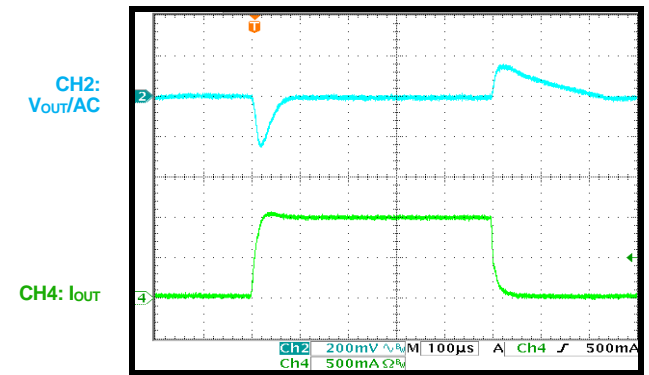

Load Transient

$I_{OUT} = 1A$ to $2A$, AAM

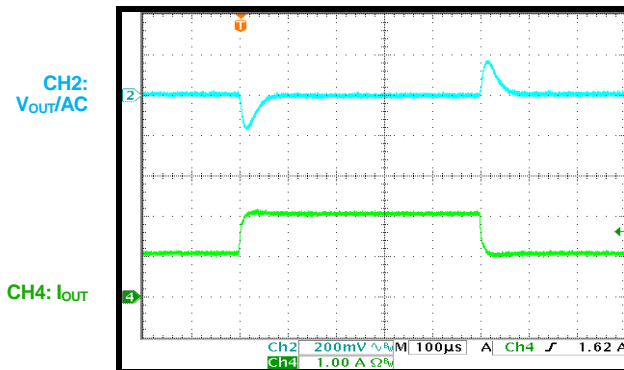

Cold Crank

$V_{IN} = 24V$ to $4V$ to $5V$, $I_{OUT} = 0A$

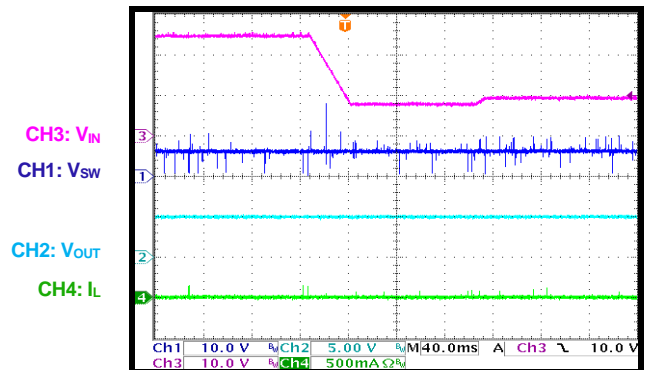

EVB TEST RESULTS (continued)

Performance curves and waveforms are tested on the evaluation board. $V_{IN} = 24V$, $V_{OUT} = 5V$, $L = 15\mu H$, $f_{SW} = 400kHz$, $T_A = 25^\circ C$, unless otherwise noted.

Cold Crank

$V_{IN} = 24V$ to $4V$ to $5V$, $I_{OUT} = 2A$

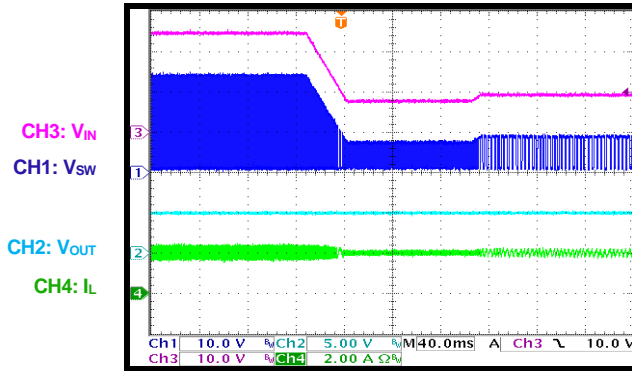

V_{IN} Ramp Down and Up

$V_{IN} = 18V$ to $4.5V$ to $0V$ to $4.5V$ to $18V$, $I_{OUT} = 0A$

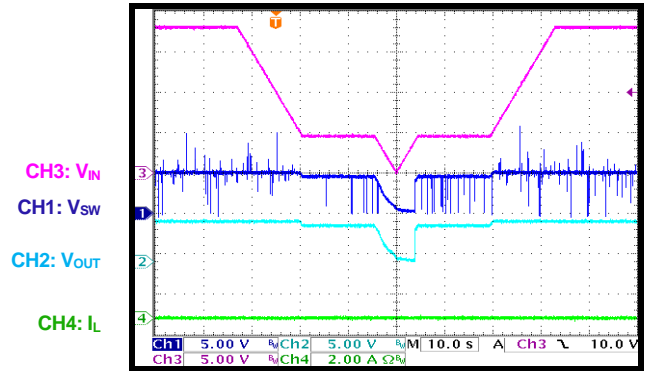

V_{IN} Ramp Down and Up

$V_{IN} = 18V$ to $4.5V$ to $0V$ to $4.5V$ to $18V$, $I_{OUT} = 2A$

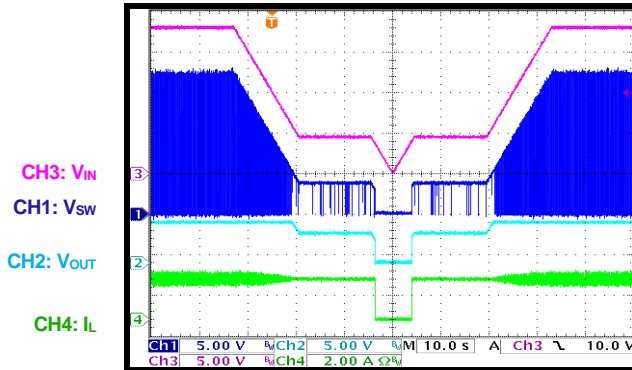

Load Dump

$V_{IN} = 24V$ to $48V$ to $24V$, $I_{OUT} = 2A$

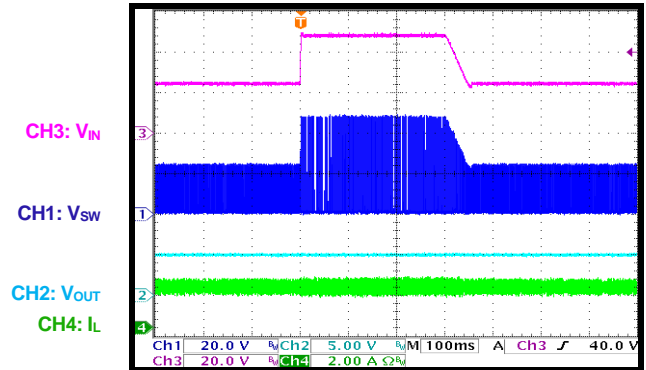

PCB LAYOUT

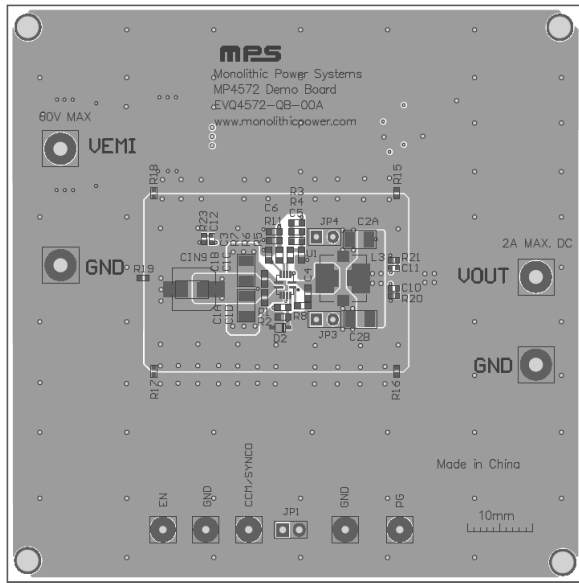

Figure 1: Top Silk and Top Layer

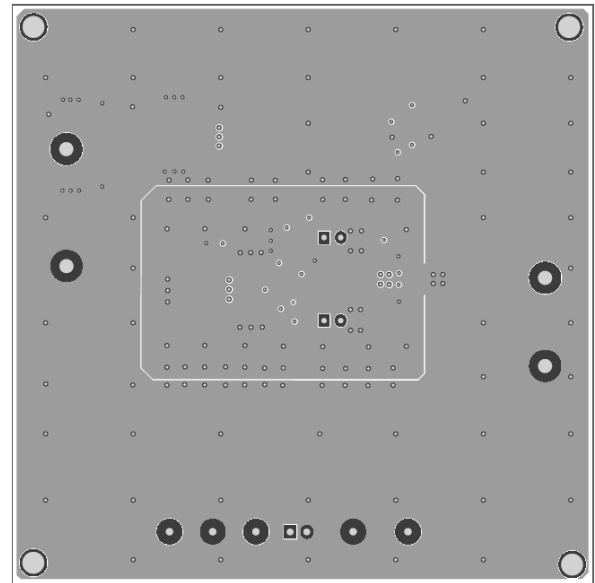

Figure 2: IN1 Layer

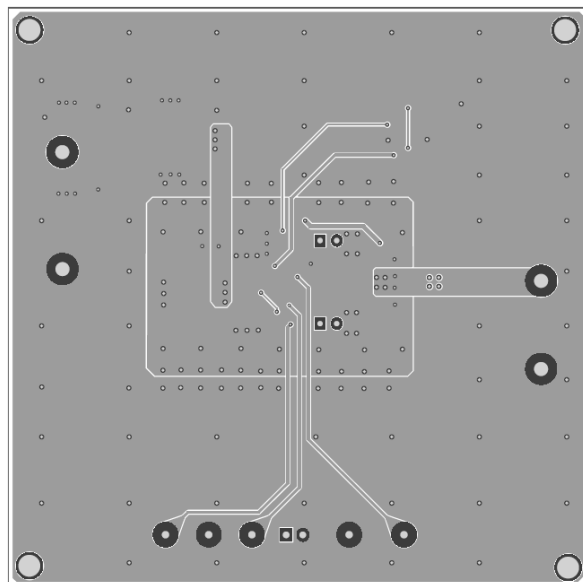

Figure 3: IN2 Layer

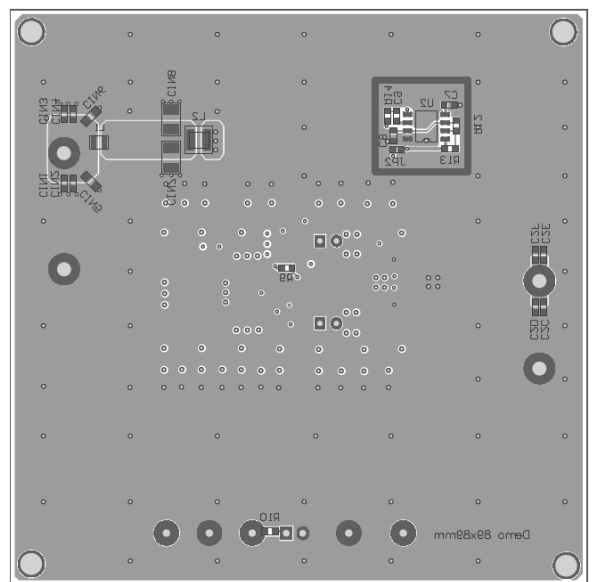

Figure 4: Bottom Silk and Bottom Layer

Revision History

Revision #	Revision Date	Description	Pages Updated
1.1	4/29/2020	Grammar updates to Quick Start Guide and BOM	2,4-5

Notice: The information in this document is subject to change without notice. Please contact MPS for current specifications. Users should warrant and guarantee that third-party Intellectual Property rights are not infringed upon when integrating MPS products into any application. MPS will not assume any legal responsibility for any said applications.