



EVQ6531-V-00A

5V to 60V, Three-Phase Brushless DC Motor Pre-Driver Evaluation Board

DESCRIPTION

The EVQ6531-V-00A is an evaluation board for the MPQ6531, a three-phase BLDC motor pre-driver.

It operates from a supply voltage of up to 60V. It is configured to drive 3 half bridges consisting of 6 N-channel Power MOSFETs. The rotor position information is provided by the Hall sensors assembled in the motor and the driving control signals are generated by the external controller, such as MCU, FPGA, etc.

ELECTRICAL SPECIFICATIONS

Parameter	Symbol	Value	Units
Input Voltage	VIN	5 - 60	V
OC_REF	OC_REF	0.1 – 2.4	V
Hall Voltage	VH	3.3 or 5	V

FEATURES

- Wide 5V to 60V Input Voltage Range
- Programmable OCP Threshold
- Support 100% Duty Cycle Operation
- OCP, OTP
- Fault Indication Output

APPLICATIONS

- 3-Phase Brushless DC Motors and Permanent Magnet Synchronous Motors
- Power Drills
- Impact Drivers
- E-Bike

All MPS parts are lead-free, halogen-free, and adhere to the RoHS directive. For MPS green status, please visit the MPS website under quality assurance. "MPS" and "The Future of Analog IC Technology" are registered trademarks of Monolithic Power Systems, Inc.

EVQ6531-V-00A EVALUATION BOARD

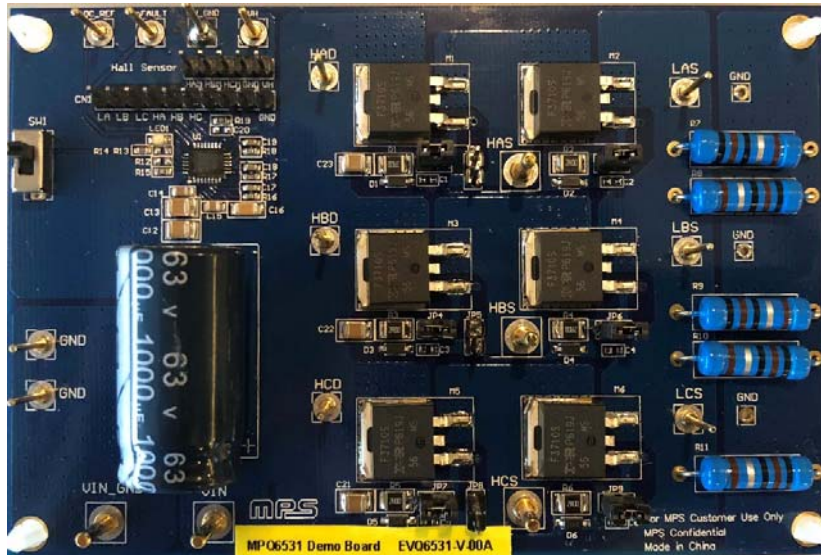

(L x W x H) 4.68" x 3.12" x 0.4"
(11.7cm x 7.8cm x 1cm)

Board Number	MPS IC Number
EVQ6531-V-00A	MPQ6531GV-AEC1

EVALUATION BOARD SCHEMATIC

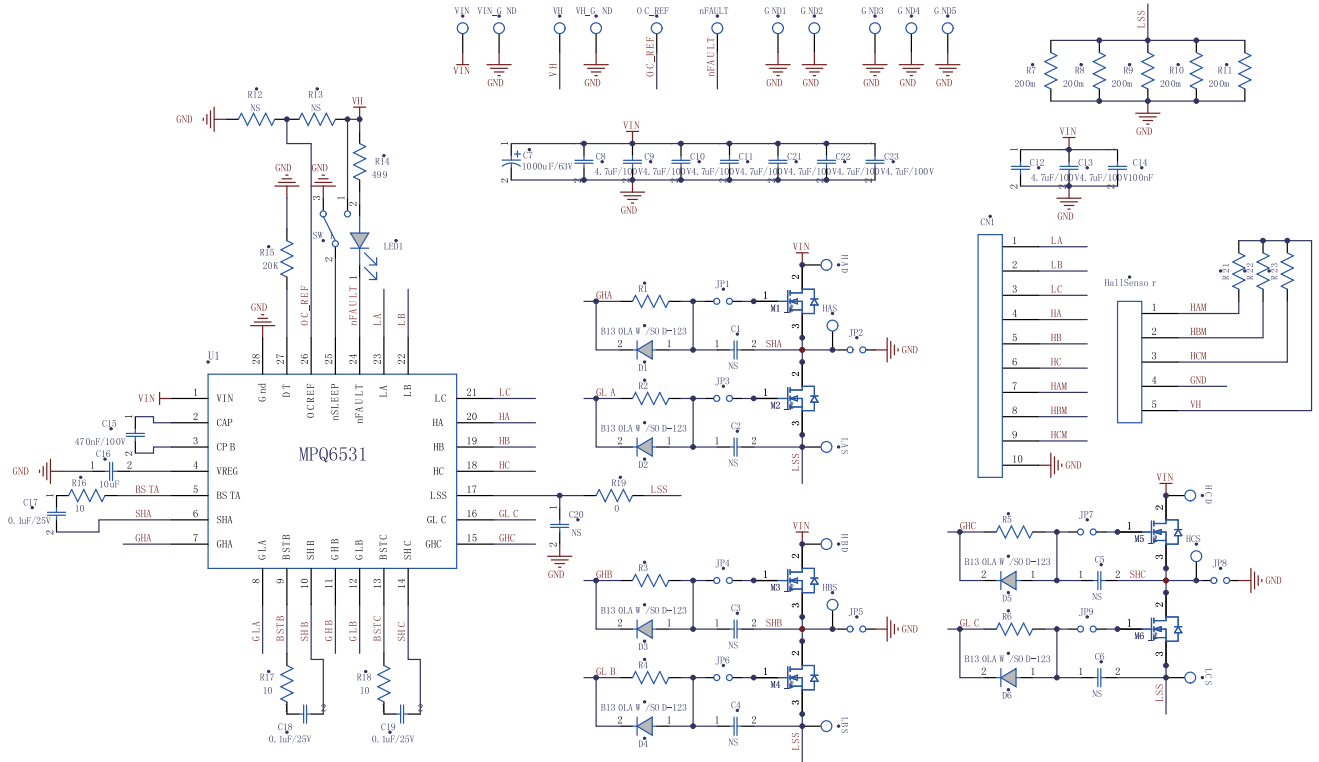

EVQ6531-V-00A BILL OF MATERIALS

Qty	RefDes	Value	Description	Package	Manufacturer	Manufacturer P/N
12	C1,C2,C3,C4,C5,C6, C20,R12,R13,R21,R 22,R23	NS				
1	C7	1000 μ F	Electrolytic Cap. 63V	DIP	Jianghai	CD263-63V1000
9	C8,C9,C10,C11,C12 ,C13,C21,C22,C23	4.7 μ F	Ceramic Cap. 100V, X7S	1210	TDK	C3225X7S2A475K
1	C14	100nF	Ceramic Cap. 100V, X7R	0805	TDK	CGA4J2X7R2A104K
1	C15	470nF	Ceramic Cap. 100V, X7R	0805	Murata	GRM21BR72A474K A73L
1	C16	10 μ F	Ceramic Cap. 25V, X5R	1206	Murata	GRM31CR61E106K A12L
3	C17,C18,C19	0.1 μ F	Ceramic Cap. 25V, X7R	0603	Murata	GRM188R71E104K A01D
6	R1,R2,R3,R4,R5,R6	2 Ω	Film Resistor. 1%	1210	Yageo	RC1210FR-072RL
5	R7,R8,R9,R10,R11	100m Ω	Resistor. 2W	DIP	闽达	
1	R14	499 Ω	Film Resistor. 1%	0603	Yageo	RC0603FR- 07499RL
1	R15	20k	Film Resistor ,1%	0603	Yageo	RC0603FR-0720KL
3	R16,R17,R18,	10 Ω	Film Resistor ,1%	0603	Yageo	RC0603FR-0710RL
1	R19	0 Ω	Film Resistor ,1%	0603	Yageo	RC0603FR-070RL
6	D1,D2,D3,D4,D5,D6		Schottky Diode. 30V, 1A	SOD- 123	Diodes	B130LAW-7-F
6	M1,M2,M3,M4,M5,M 6		N-channel MOSFET, 100V,57A, Qg=130nC, 23m Ω @Vgs=10V , Id=28A	TO-263	IR	IRF3710S
1	LED1		LED. 红光	0805	Bright LED	BL-HUF35A-TRB
1	SW1		Button			SK-12D01EG4
9	JP1,JP2,JP3,JP4,JP 5,JP6,JP7,JP8,JP9		2PIN. 2.54MM			
6	JP1,JP3,JP4,JP6,JP 7,JP9		2.54MM Short Jumper			
1	CN1		10PIN. 2.54MM			
1	Hall Sensor		5PIN. 2.54MM			
5	VIN,VIN_GND,HAS, HBS,HCS		2.0 公针			
9	OC_REF,nFAULT, VH,VH_GND,LAS,L BS,LCS,GND,GND		1.0 公针			
1	U1		3-Phase BLDC Motor Pre-Driver	QFN28 (4x5mm)	MPS	MPQ6531GV-AEC1

PRINTED CIRCUIT BOARD LAYOUT

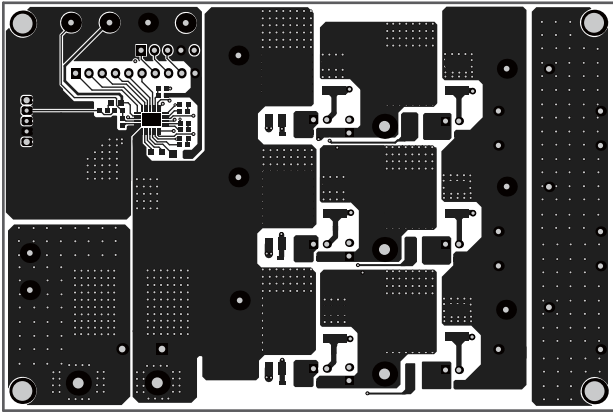

Figure 1: Top

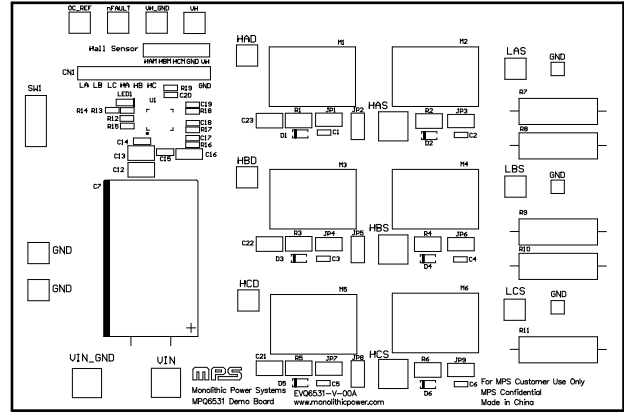

Figure 2: Top Silk

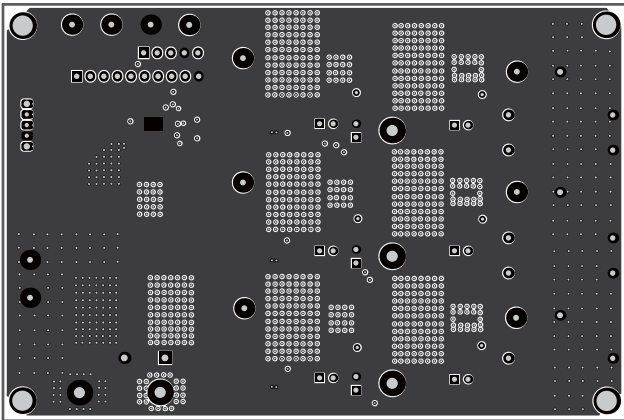

Figure 3: Inner1

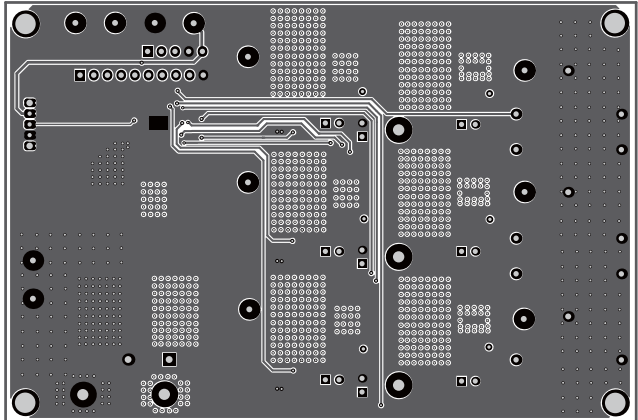

Figure 4: Inner2

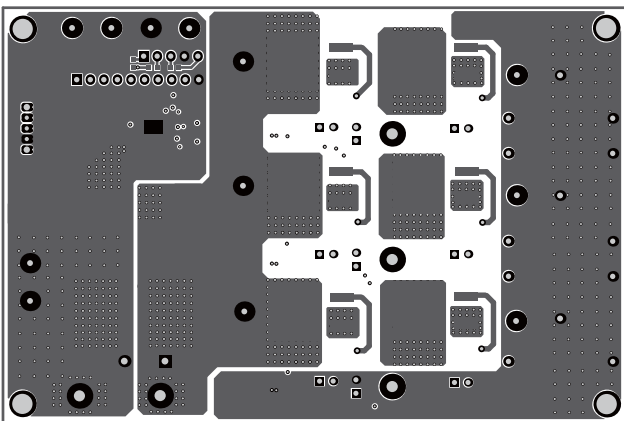

Figure 5: Bottom

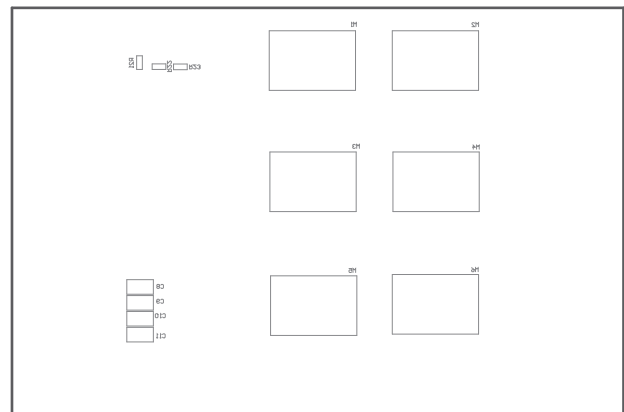

Figure 6: Bottom Silk



QUICK START GUIDE

1. Attach the input voltage ($5V \leq V_{IN} \leq 60V$) and input ground to the VIN and GND connectors respectively.
2. Attach a 3.3V or 5V constant voltage to the VH connector and switch the SW1 to the position 1(Top side) to enable the chip.
3. Attach the OCP reference voltage ($0.1V \leq V_{OC_REF} \leq 2.4V$) to the OC_REF connector to set OCP threshold.
4. Attach the hall signals coming from the motor to the Hall Sensor connector.
5. Attach the driving control signals generated by the external controller to the CN1 connector.

NOTICE: The information in this document is subject to change without notice. Users should warrant and guarantee that third party Intellectual Property rights are not infringed upon when integrating MPS products into any application. MPS will not assume any legal responsibility for any said applications.
