



EVQ8112A-J-00A

60V, High-Side Current-Sense Amplifier Evaluation Board, AEC-Q100 Qualified

DESCRIPTION

The EVQ8112A-J-00A is an evaluation board designed to demonstrate the capabilities of the MPQ8112A, a low-cost, unipolar, high-side current-sense amplifier. The device operates from a 2.7V to 60V supply voltage and typically consumes a 300 μ A current. The common mode input voltage ranges between 0V and 60V with a 700kHz high bandwidth.

The MPQ8112A converts the differential input voltage to a current output. This current is converted back to a voltage with an external load resistor. The MPQ8112A has an adjustable gain based on the external, common input resistors and load resistor.

The EV8112A-J-00A is a fully assembled and tested evaluation board.

The MPQ8112A is available in a TSOT23-6L package.

ELECTRICAL SPECIFICATIONS

Parameter	Symbol	Value	Units
VCC supply voltage	V _{CC}	2.7 to 60	V
Common input voltage	V _{CM}	0 to V _{CC}	V
V5 supply voltage	V5	2.7 to 5.5	V
Sense voltage	V _{SENSE}	0 to 200	mV
Output gain	A _v	50	V/V

FEATURES

- Low-Cost, Compact Current-Sense Solution
- 700kHz Bandwidth
- 300 μ A Typical Supply Current
- 2.7V to 60V Operating Supply Voltage Range
- 0V to 60V Common Mode Input Voltage Range
- 0.2 μ A Typical Shutdown Current
- 300 μ V Input Offset Voltage
- Available with Adjustable Gain
- \pm 1% Current-Sense Gain Accuracy
- High-Current Sensing Capabilities
- Available in a 6-Pin TSOT23-6L Package
- Available in AEC-Q100 Grade 1

APPLICATIONS

- Advanced Driver Assistance Systems (ADAS)
- Sensor Fusion Systems
- Electric Power Steering (EPS) Systems
- Electronic Stability Control (ESC) Systems
- Brake Systems
- Battery-Operated Systems
- Energy Management Systems

All MPS parts are lead-free, halogen-free, and adhere to the RoHS directive. For MPS green status, please visit the MPS website under Quality Assurance. "MPS", the MPS logo, and "Simple, Easy Solutions" are trademarks of Monolithic Power Systems, Inc. or its subsidiaries.

EVQ8112A-J-00A EVALUATION BOARD

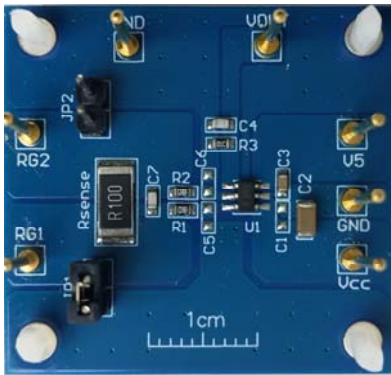

LxWxH (3.6cmx3.4cmx1.3cm)

Board Number	MPS IC Number
EVQ8112A-J-00A	MPQ8112A

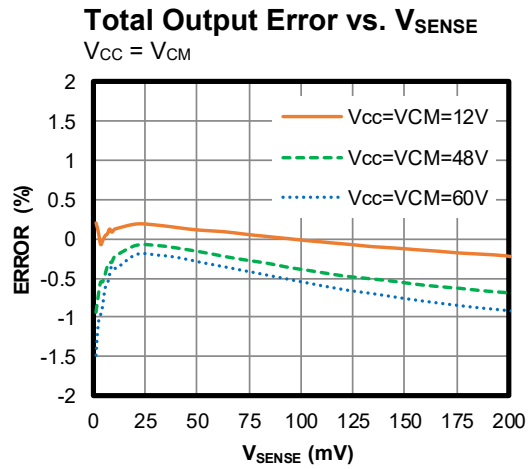

QUICK START GUIDE

1. Preset the power supply (V_{CC}) to be between 2.7V and 60V.
2. Turn the VCC power supply off.
3. Preset the V5 power supply to be between 2.7V and 5.5V.
4. Turn the V5 power supply off.
5. Preset the I_{SENSE} load to be between 0A and 2A. This sets V_{SENSE} between 0mV and 200mV ($V_{SENSE} = I_{SENSE} \times R_{SENSE}$).
6. Turn the I_{SENSE} load off.
7. Ensure that JP1 and JP2 are not shorted simultaneously. To set the JP1 and JP2 connections, follow the guidelines below:
 - a. To test with $V_{CC} = V_{CM}$, short JP1 and open JP2.
 - b. To test with $V_{CC} > V_{CM}$ and $V_{CM} = 0V$, open JP1 and short JP2.
8. Connect the VCC power supply terminals to:
 - a. Positive (+): VCC
 - b. Negative (-): GND
9. Connect the V5 power supply terminals to:
 - a. Positive (+): V5
 - b. Negative (-): GND
10. To test with $V_{CC} = V_{CM}$, short JP1 and open JP2, and then connect the load terminals to:
 - a. Positive (+): RG2
 - b. Negative (-): GND
11. To test with $V_{CC} > V_{CM}$ and $V_{CM} = 0V$, open JP1 and short JP2. Isolate the I_{SENSE} load supply with an isolation transformer, and then connect the load terminals to:
 - a. Positive (+): RG1
 - b. Negative (-): GND
12. Turn the V5 power supply on. Then turn the VCC power supply on after making the connections.
13. Turn the I_{SENSE} load on and adjust the I_{SENSE} range. The MPQ8112A's output (V_{OUT}) can be estimated with Equation (1):

$$V_{OUT} = I_{SENSE} \times R_{SENSE} / R1 \times G_M \times R3 \quad (1)$$

Where G_M is 5A/A. The MPQ8112A's gain (A_V) can be adjusted by selecting different combinations of R3 and R1. A_V can be estimated with Equation (2):

$$A_V = V_{OUT} / V_{SENSE} = R3 / R1 \times G_M \quad (2)$$

Table 1 lists the possible A_V values using different resistors.

Table 1: Selecting A_V

A_V (V/V)	R1/R2 (k Ω)	R3 (k Ω)
100	1	20
50	1	10
25	1.02	5.1
10	1	2

EVALUATION BOARD SCHEMATIC

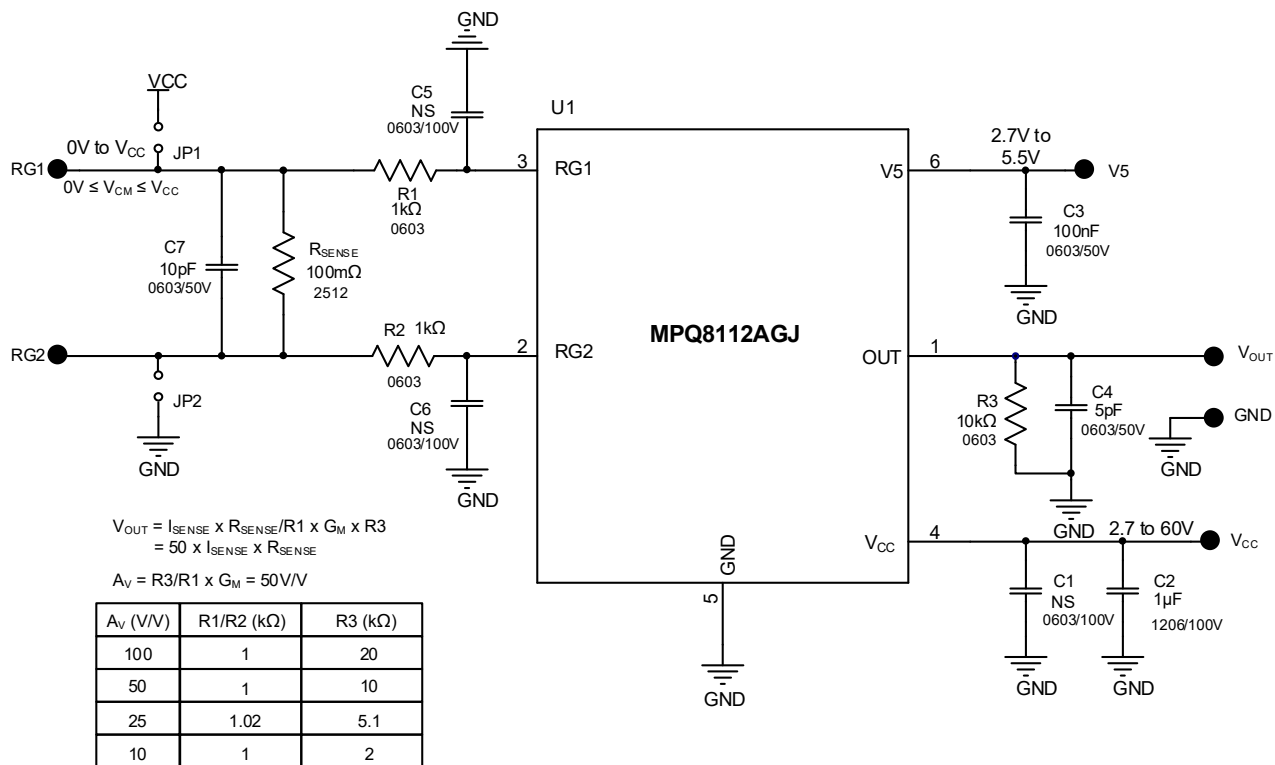
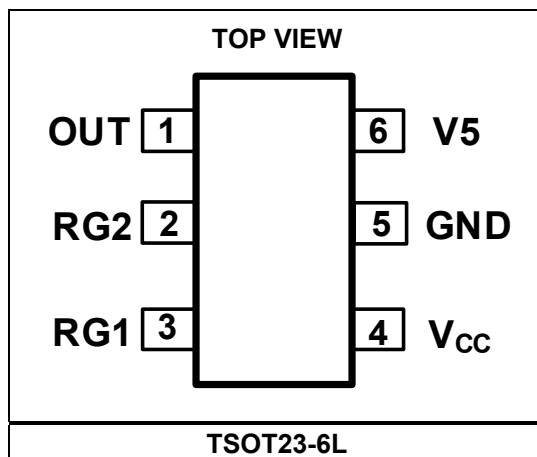

Figure 1: Evaluation Board Schematic

PACKAGE REFERENCE



EVQ8112A-J-00A BILL OF MATERIALS

Qty	Ref	Value	Description	Package	Manufacturer	Manufacturer P/N
3	C1, C5, C6	NS	Ceramic capacitor, 100V, X7R	0603		
1	C2	1 μ F	Ceramic capacitor, X7R, 100V	1206	Murata	GRM31CR72A105KA01L
1	C3	0.1 μ F	Ceramic capacitor, 50V, X7R	0603	Murata	GRM188R71H104KA93D
1	C4	5pF	Ceramic capacitor, COG, 50V	0603	TDK	C1608C0G1H050C
1	C7	10pF	Ceramic capacitor, COG, 50V	0603	muRata	GRM1885C1H100JA01
2	R1, R2	1k Ω	Film resistor, 1%	0603	Yageo	RC0603FR-071KL
1	R3	10k Ω	Film resistor, 1%	0603	Yageo	RC0603FR-0710KL
1	R _{SENSE}	100m Ω	Film resistor, 1%, 1W	2512	Yageo	RL2512FK-070R1L
1	U1	MPQ8112A	Current-sense amplifier	TSOT23- 6L	MPS	MPQ8112AGJ
2	JP1, JP2	2.54mm	2 x 1, 2.54mm, 180° connector		Custom	
1	JP1	2.54mm	2.54mm jumper		Custom	
7	V5, Vcc, RG1, RG2, GND, GND, VOUT	Test point	1.0 golden pin		Custom	

EVB TEST RESULTS

$V_{CC} = 12V$, $V_{RG1} = 12V$, $V_5 = 5V$, $T_A = 25^\circ C$, $R_1 = R_2 = 1k\Omega$, and $R_3 = 10k\Omega$, unless otherwise noted.

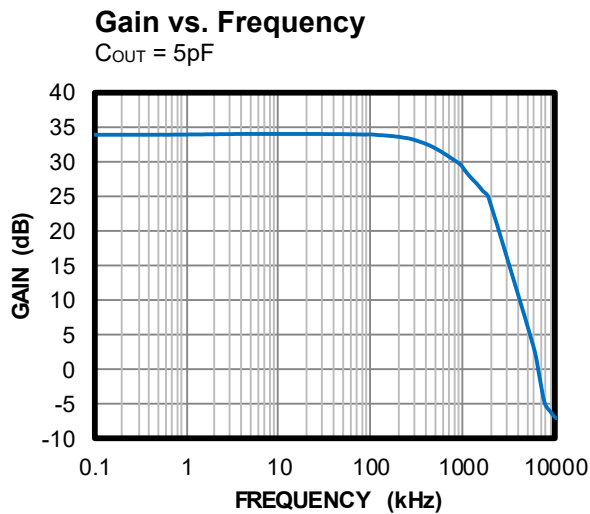
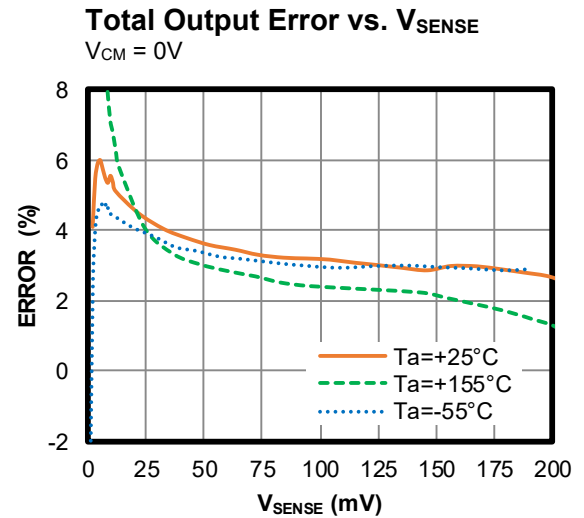
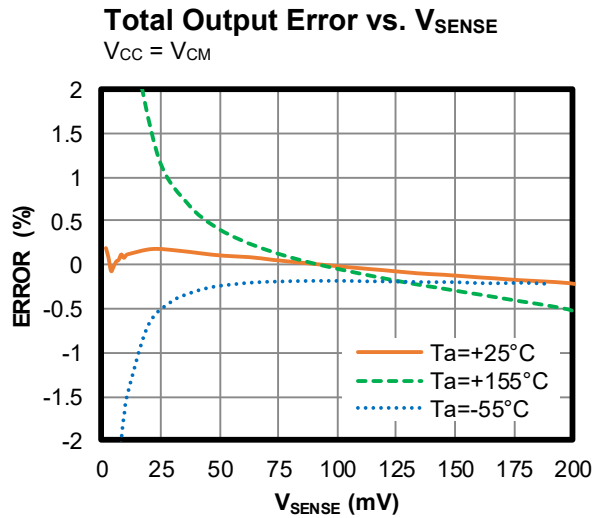
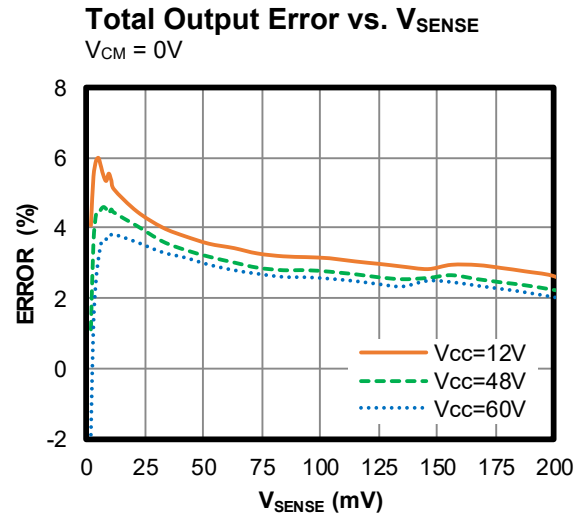
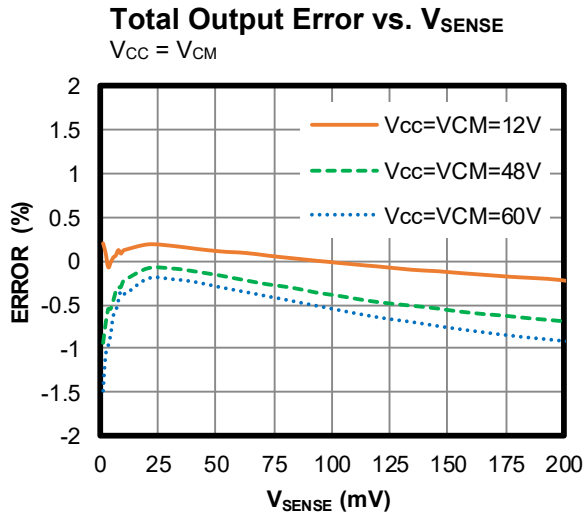

EVB TEST RESULTS (continued)

$V_{CC} = 12V$, $V_{RG1} = 12V$, $V_5 = 5V$, $T_A = 25^\circ C$, $R_1 = R_2 = 1k\Omega$, and $R_3 = 10k\Omega$, unless otherwise noted.

Transient Response

$V_{SENSE} = 0mV$ to $100mV$

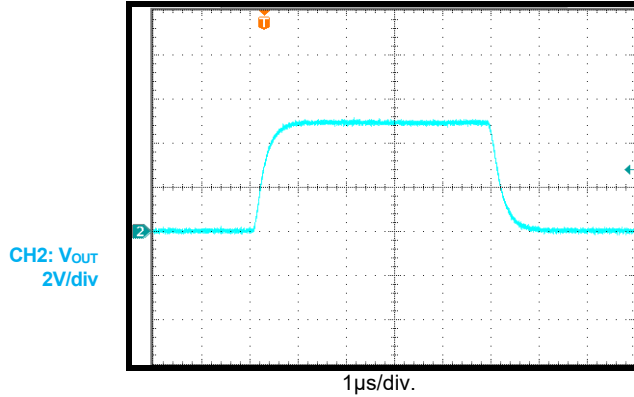

Transient Response

$V_{SENSE} = 0mV$ to $200mV$

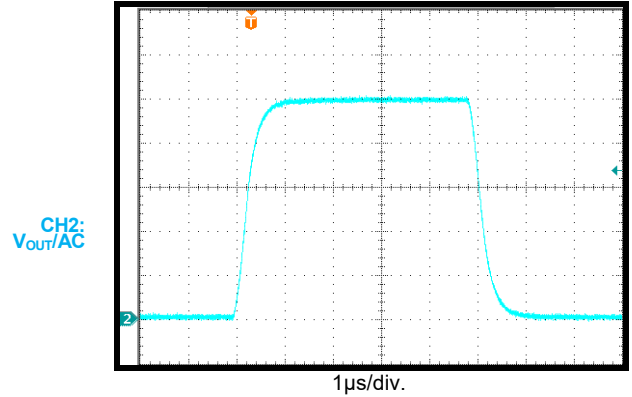

Transient Response

$V_{SENSE} = 100mV$ to $200mV$

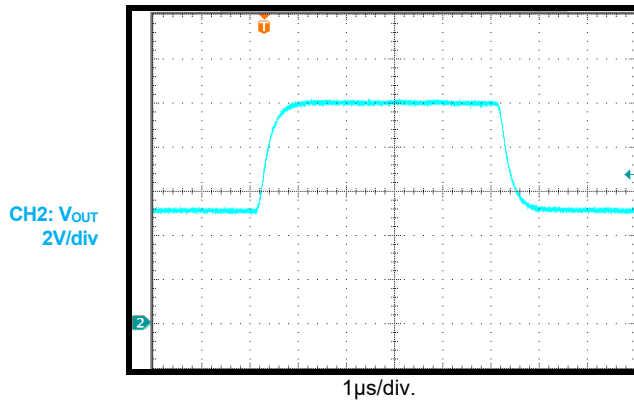

PCB LAYOUT

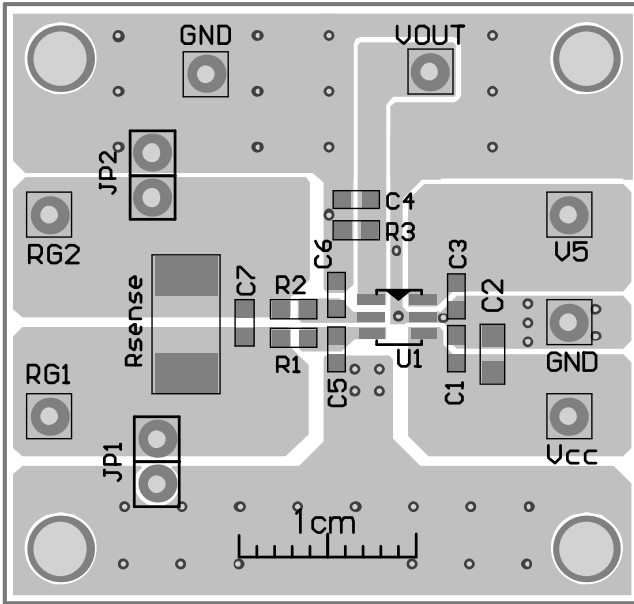

Figure 2: Top Silk Layer

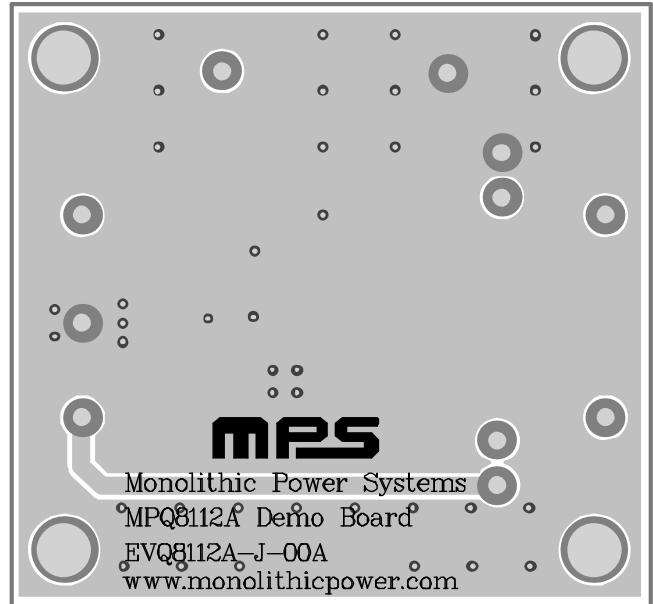

Figure 3: Bottom Layer



REVISION HISTORY

Revision #	Revision Date	Description	Pages Updated
1.0	06/08/2021	Initial Release	-

Notice: The information in this document is subject to change without notice. Please contact MPS for current specifications. Users should warrant and guarantee that third-party Intellectual Property rights are not infringed upon when integrating MPS products into any application. MPS will not assume any legal responsibility for any said applications.