



MMP742052-24

eMotion System Motor Control Board

Position/Speed/Torque Mode

DESCRIPTION

The **MMP742052-24** is part of a family of smart motor control boards for servo motor applications. This design is capable of delivering 52W continuous power and is designed to fit NEMA 17 format 42mm motors.

Board features:

- Embedded angular sensor
- FOC control
- Selectable position, speed, and torque loop mode
- RS485 and PULSE/DIR input interface.

The user can choose from three options: speed control mode, position control mode, or speed/position control mode.

Easy-to-use GUI software provides flexibility as it allows users to optimize the design online through the RS485 control interface. The parameters are saved in the control board's non-volatile memory.

Users can also order a complete motor (**MSM942052-24**). A datasheet for the MSM942052-24 is available for download at www.monolithicpower.com.



Motor Control PCBA

FEATURES

- 18V to 36V Input Voltage Range
- Max. 52W Continuous Power Output
- 0.3° Position Resolution
- RS485 Interface and PULSE/DIR Interface
- Position Control and speed control
- Operating Temperature: 0°C - 70°C (Power Derated > 40°C)
- Storage Temperature: -40°C - 125°C

ORDERING INFORMATION

Part Number	Diameter (mm)	Power (W)	Typical Voltage (V)	Control Mode	Interface
MMP742052-24-C	42	52	24	Speed /Position	RS485 Pul/Dir

RECOMMENDED OPERATING CONDITIONS

Input voltage..... 18V – 36V
 Control interface voltage..... 0V–5.5V
 Max. pulse frequency..... 500KHZ
 RS485 A/B voltage..... 0V–5.5V
 RS485 common mode voltage +/-15V
 Operation temperature..... 0°C - 70°C
 Storage temperature..... -40°C - 125°C

Motor Control Board

Parameters	Condition	Value	Units
Input Voltage		24	V
Output Power	0°C - 40°C	52	W
Position Resolution		0.3	°

INSTALLATION OF PCB ASSEMBLY IN SMART MOTOR

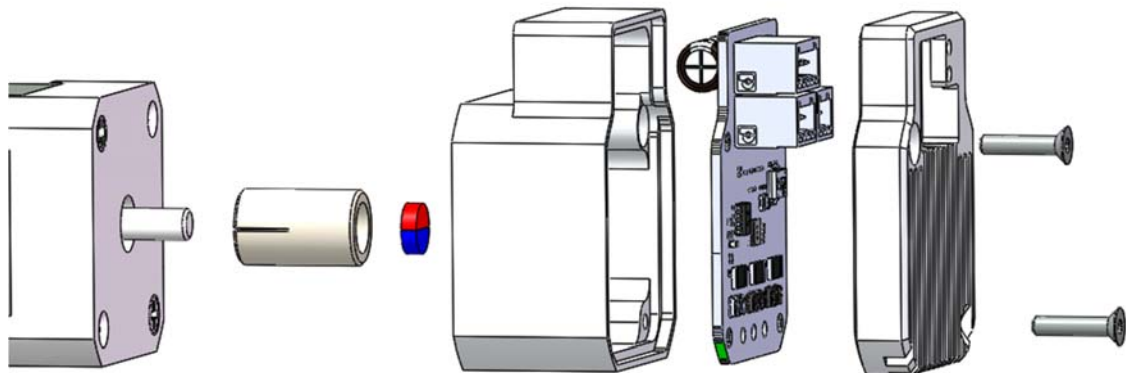

See the motor control PCB assembly and installation into a motor in the figure above. The user can manufacture their own control board housing and magnet holder based on the actual motor dimension. MPS will supply the magnet.

See Table 1 for examples/recommended magnets for use with the MMP module. A sintered NdFeB or SmCo magnet with a 6 or 8 mm diameter and 2.5 to 3mm height with remanent field strength in the range 1.0 to 1.2 T is recommended. The diameter of the magnet will depend on the specific motor shaft and holder design used. It is important that the magnetization is diametrically polarized.

The magnet airgap spacing to the sensor surface should be set to achieve a field strength in the range of 30mT min to 80mT max. The MPS magnetic simulation tool at <http://sensors.monolithicpower.com/> can be used to find the correct airgap spacing's for the particular magnet used.

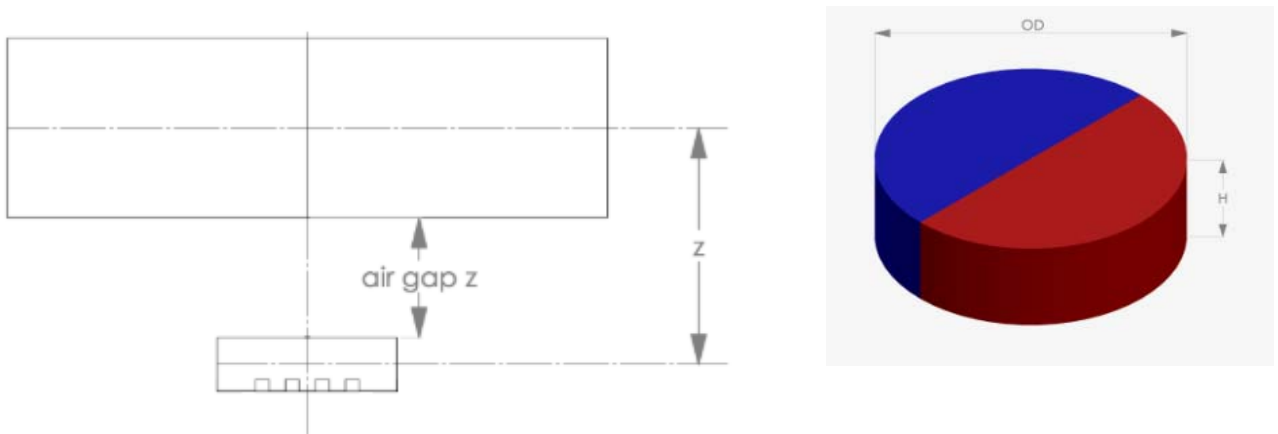

Table 1: Recommended Magnets Specifications

OD (mm)	H (mm)	Material	Remanence (Br) (T)	Magnetization	Recommended "air gap z" mm min/max
6.0	2.5	N35	1.2	Diametrical	1.5 to 3.5
6.0	2.5	Sm26/16	1.08	Diametrical	1.3 to 3.3
6.0	3.0	N35	1.2	Diametrical	1.8 to 3.8
6.0	3.0	Sm26/16	1.08	Diametrical	1.5 to 3.6
8.0	2.5	N35	1.2	Diametrical	1.8 to 4.5
8.0	2.5	Sm26/16	1.08	Diametrical	1.5 to 4.1
8.0	3.0	N35	1.2	Diametrical	2.1 to 4.8
8.0	3.0	Sm26/16	1.08	Diametrical	1.8 to 4.5

Choosing between Neodymium or Samarium Cobalt material depends on the target motor end application. Samarium Cobalt magnets have a higher working temperature range and higher corrosion resistance.

Choosing the right holder material is important. It should be of a nonmagnetic material such as aluminum, brass, or plastic so as not to influence or distort the sensor magnets field. The attachment method to the shaft is left to the user to determine based on the design criteria for the motor. To avoid detachment due to the different coefficients of thermal expansion for the magnet, holder, and shaft, the use of a high temperature industrial adhesive is one possible approach.

The magnet holder requires a motor with a shaft that extends from the rear of the motor. Contact your individual motor supplier to discuss what options they have for shaft diameter and length. This will determine the holder size and housing depth required.

The PCB housing should be designed to take into account any heatsinking requirements for the motor driver components, additional bulk motor supply capacitance, and EMC filtering as may be required to meet the target application specifications. The housing should center the central angle sensor IC to align to the motor shaft magnet holder with no more than +/-0.4mm of axial misalignment.

HARDWARE CONNECTION FOR PROGRAMMING SMART MOTOR

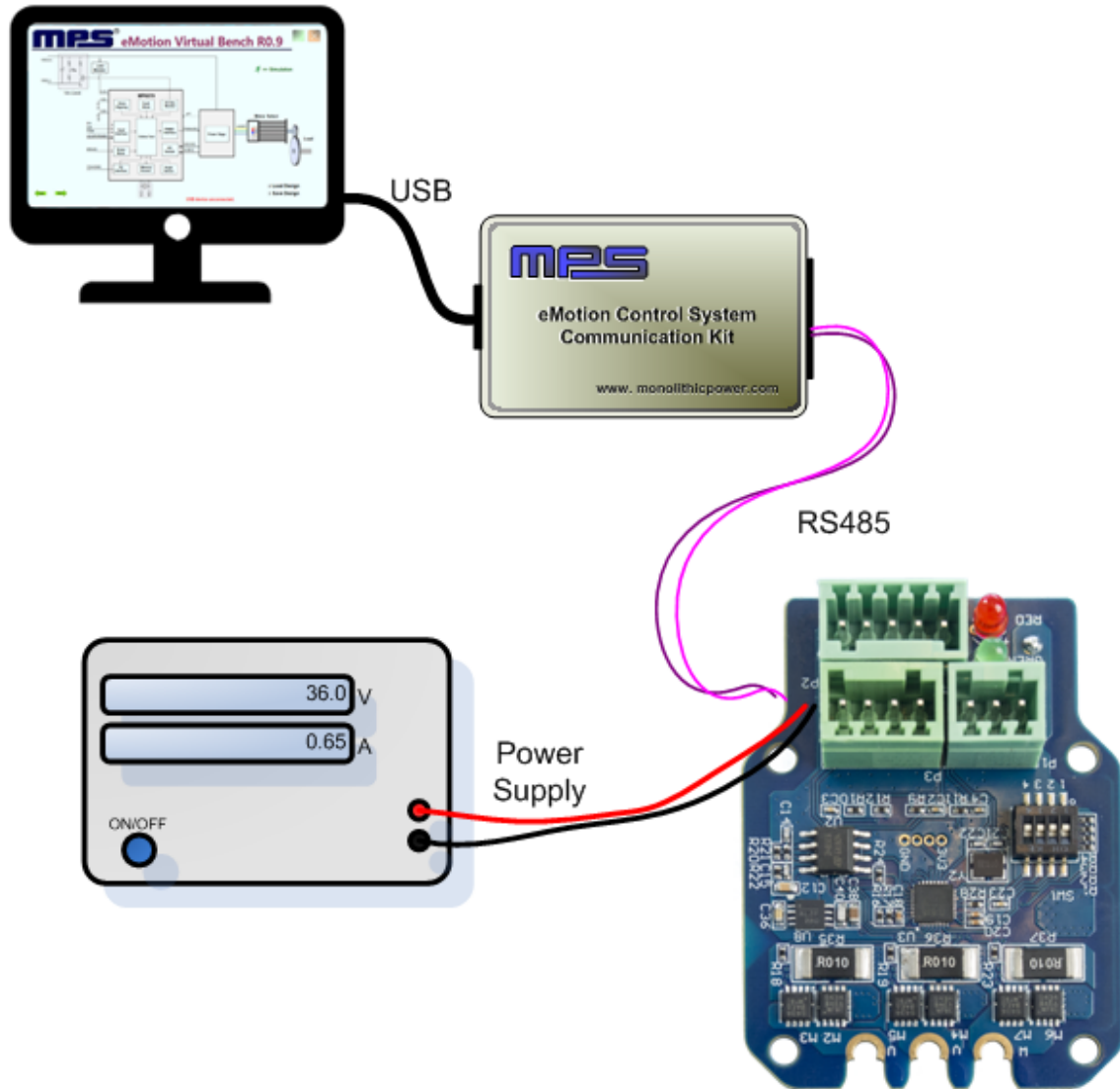

PIN CONFIGURATION

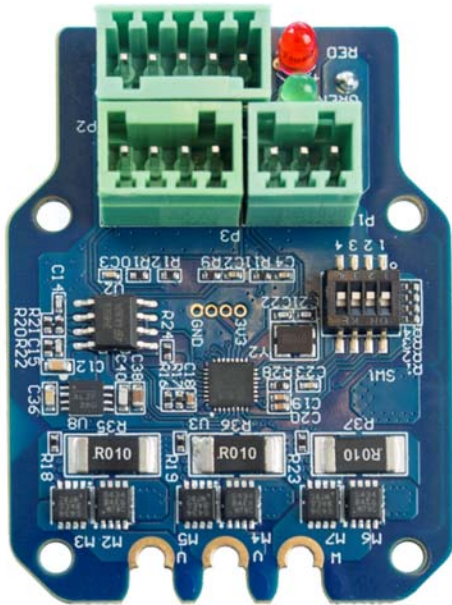
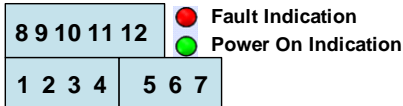

Pin Number	Designation	Pin Description
RS485 Interface		
1	EXT_5V	5V Input For Firmware Programming
2	B	RS485 Node B
3	AGND	RS485 Ground
4	A	RS485 Node A
Power Interface		
5	GND	Power Ground
6	R-	Shunt Resistor Return Node
7	VIN	Input Power Supply
Control Interface		
8	COM-	Common Return
9	EN+	Enable Input
10	PEND+	Position End Output
11	PUL+	Pulse Input
12	DIR+	Direction Input

TYPICAL PERFORMANCE CHARACTERISTICS

T_a=25°C, VIN=24V, unless otherwise noted

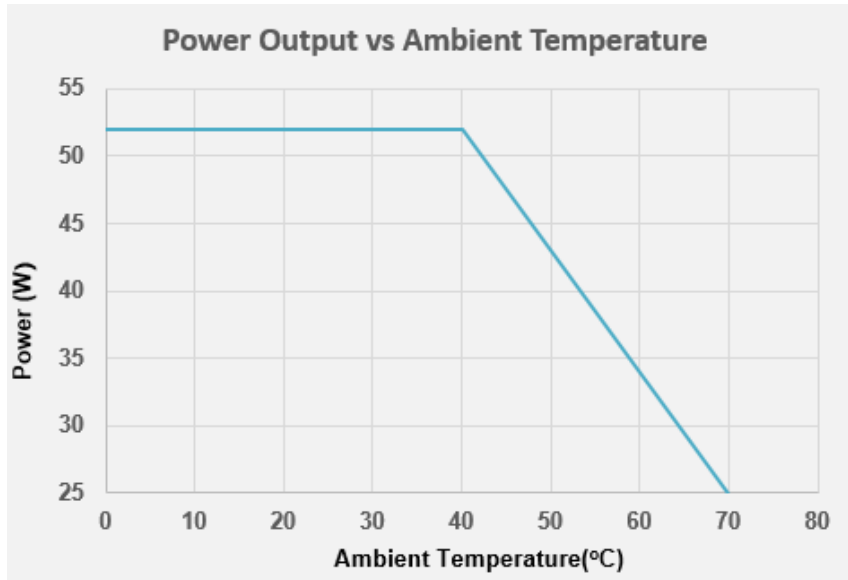

DRIVER MODUE MECHANICAL DRAWING

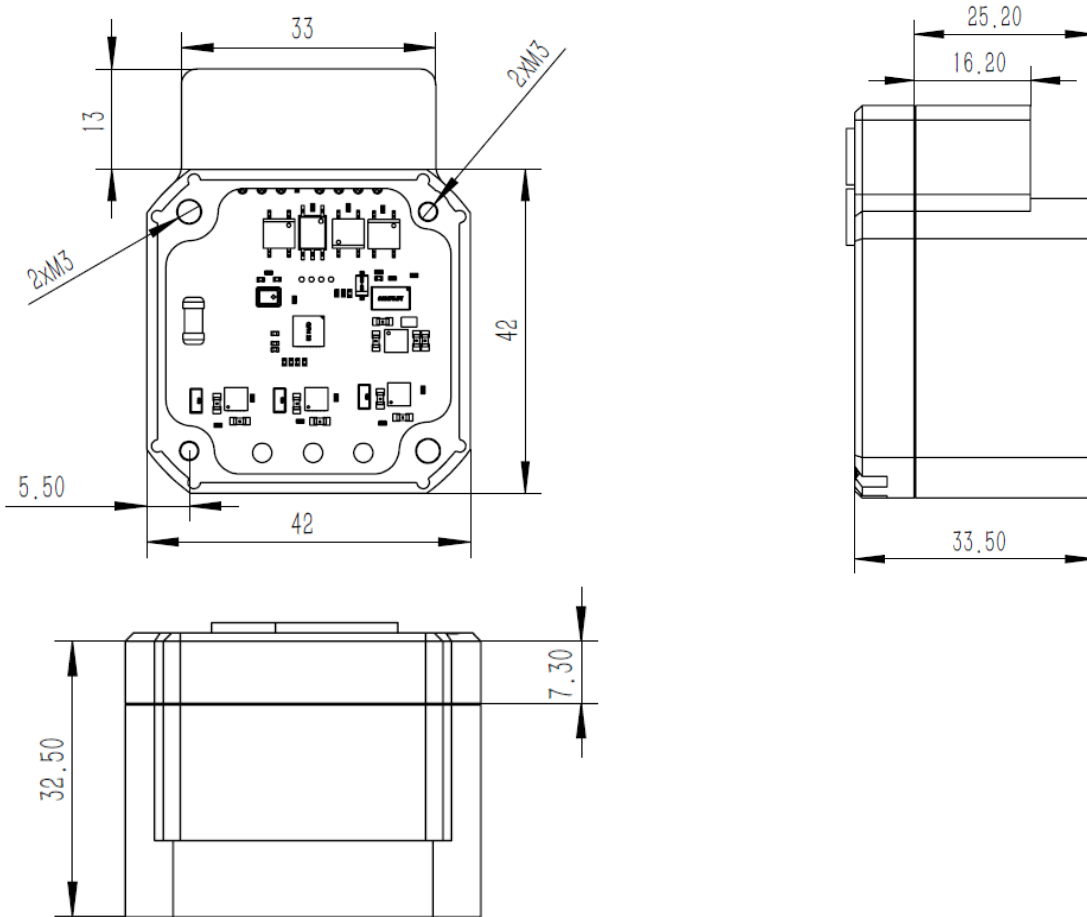

Note that no housing is supplied with the MMP742052 PCB.

The above drawings are for illustration only and are based on dimensions for a NEMA 17 format motor.

Contact your individual motor supplier for the particular mounting hole positions and dimension information.

NOTICE: The information in this document is subject to change without notice. Users should warrant and guarantee that third party Intellectual Property rights are not infringed upon when integrating MPS products into any application. MPS will not assume any legal responsibility for any said applications.