

### DESCRIPTION

The MP2113 is a fully integrated, internally compensated 1.5MHz fixed frequency PWM step-down converter with dynamic output voltage control. User can select two operation modes, forced PWM and asynchronous mode. Force PWM is ideal for high load operation while asynchronous mode improves efficiency at light load condition. Each mode has independent output level that can be set by the user to optimize the power efficiency. It is ideal for powering portable equipment that runs from a single cell Lithium-Ion (Li+) Battery, with an input range from 2.7V to 6V. The MP2113 can provide 1.5A of load current in forced PWM mode and 50mA in asynchronous mode. Both output voltage can be regulated to as low as 0.6V.

MP2113 integrates the high side switch, a synchronous rectifier for forced PWM mode and a Schottky diode for asynchronous mode operation. With peak current mode control and internal compensation, the MP2113 is stable with ceramic capacitors and small inductors. Fault condition protection includes cycle-by-cycle current limiting and thermal shutdown.

MP2113 is available in the small 8-pin 2mmx3mm QFN package.

### FEATURES

- User Selectable Operation Mode: Forced PWM and Asynchronous Mode
- User Programmable Output Level for Each Operation Mode
- Dynamic Output Voltage Control
- Up to 1.5A Output Current for Forced PWM Mode, 50mA for Asynchronous Mode
- Internal Power MOSFET Switches and Schottky diode
- Stable with Low ESR Output Ceramic Capacitors
- Up to 95% Efficiency
- 1µA Shutdown Current.
- 1.5MHz Switching Frequency
- Thermal Shutdown
- Cycle-by-Cycle Over Current Protection
- Short circuit protection
- Power-Good Output
- 2.7-6V Input Operation Range
- Output Adjustable from 0.6V to VIN
- Available in 8-pin 2x3mm QFN Package

### APPLICATIONS

- DVD+/-RW Drives
- Smart Phones
- PDAs
- Digital Cameras
- Portable Instruments

"MPS" and "The Future of Analog IC Technology" are Registered Trademarks of Monolithic Power Systems, Inc.

### TYPICAL APPLICATION

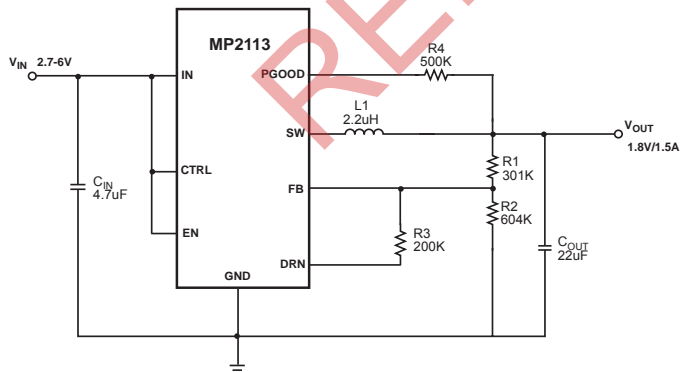

Efficiency vs. Load Current

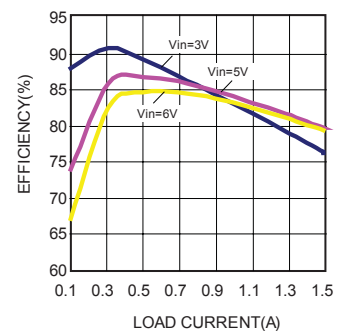

## PACKAGE REFERENCE

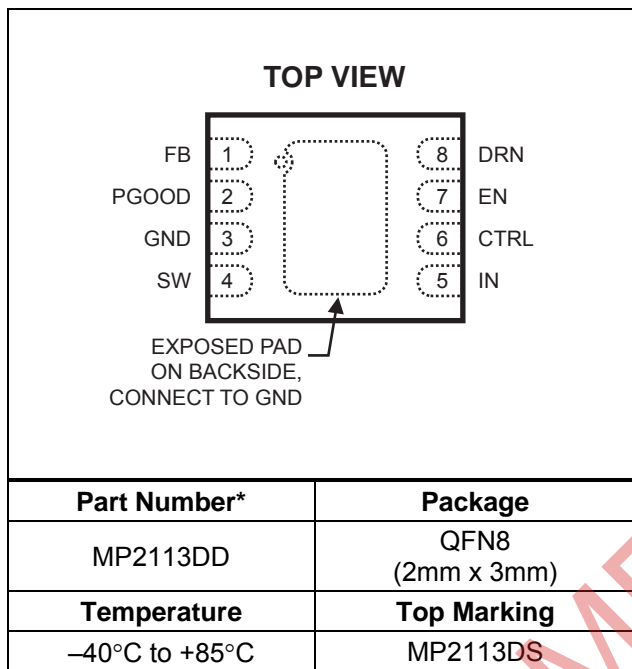

\* For Tape & Reel, add suffix -Z (eg. MP2113DD-Z)  
 For RoHS compliant packaging, add suffix -LF  
 (eg. MP2113DD-LF-Z)

## ABSOLUTE MAXIMUM RATINGS <sup>(1)</sup>

IN to GND	-0.3V to + 6.5V
SW to GND	-0.3V to $V_{IN} + 0.3V$
PGOOD, EN, CTRL to GND	-0.3V to +6.5V
FB, DRN to GND	-0.3V to +6.5V
Operating Temperature	-40°C to +85°C
Junction Temperature	150°C
Lead Temperature	260°C
Storage Temperature	-65°C to +150°C

## Recommended Operating Conditions <sup>(2)</sup>

Supply Voltage $V_{IN}$	2.7V to 6V
Operating Temperature	-40°C to +85°C

Thermal Resistance <sup>(3)</sup>	$\theta_{JA}$	$\theta_{JC}$
QFN8 (2mm x 3mm)	50	12... °C/W

### Notes:

- 1) Exceeding these ratings may damage the device.
- 2) The device is not guaranteed to function outside of its operating conditions.
- 3) Measured on JESD51-7, 4-layer PCB.

## ELECTRICAL CHARACTERISTICS <sup>(4)</sup>

$V_{IN} = V_{EN} = 3.6V$ ,  $T_A = +25^\circ C$ , unless otherwise noted.

Parameters	Condition	Min	Typ	Max	Units
Supply Current	$V_{EN} = V_{IN}$ , $V_{CTRL} = V_{IN}$ (forced PWM Mode)		500	650	$\mu A$
	$V_{EN} = V_{IN}$ , $V_{CTRL} = 0$ (asynchronous Mode)		55	85	
Shutdown Current	$V_{EN} = 0V$ , $V_{IN} = 6V$		0.1	1	$\mu A$
Thermal Shutdown Trip Threshold	Hysteresis=20°C		145		°C
PGOOD Upper Trip Threshold	FB wrt the nominal value		12		%
PGOOD Lower Trip Threshold	FB wrt the nominal value		-10		%
PGOOD Output Lower Voltage	ISINK=1mA			0.3	V
PGOOD Deglitch Timer	Transient Deglitch		200		$\mu s$
EN Trip High Threshold		1.5			V
EN Trip Low Threshold				0.5	V
EN Input Control	$V_{EN} = 0V$		0.1	1.0	$\mu A$
	$V_{EN} = 6V$		6		$\mu A$
CTRL Trip Threshold	Rising edge, $V_{IN} - 0.8V$	1.8			V
	Falling edge GND			0.4	V
CTRL Input Current	$V_{EN} = 0V$ to 6V	-1	0.1	1	$\mu A$
DRN output resistance	$CTRL = V_{IN}$			100	$\Omega$
	$CTRL = 0$	10			M $\Omega$

**ELECTRICAL CHARACTERISTICS (continued) <sup>(4)</sup>**
 $V_{IN} = V_{EN} = 3.6V$ ,  $T_A = +25^{\circ}C$ , unless otherwise noted.

Parameters	Condition	Min	Typ	Max	Units
IN Undervoltage Lockout Threshold	Rising Edge		2.40	2.65	V
IN Undervoltage Lockout Hysteresis			160		mV
Regulated FB Voltage	$T_A = +25^{\circ}C$	0.588	0.600	0.612	V
	$-40^{\circ}C \leq T_A \leq +85^{\circ}C$	0.582	0.600	0.618	
Regulated FB Voltage Hysteresis	CTRL = 0 (Async Mode)		12	20	mV
FB Input Bias Current	$V_{FB} = 0.7V$	-50	-2	+50	nA
SW PFET On Resistance	$I_{SW} = 100mA$		0.25		$\Omega$
SW NFET On Resistance	$I_{SW} = -100mA$		0.19		$\Omega$
SW Schottky Diode Forward Voltage	$I_{SW} = -50mA$		-0.5		V
SW PFET Leakage Current	$V_{EN} = 0V$ ; $V_{IN} = 6V$ ; $V_{SW} = 0V$	-1	0.1	1	$\mu A$
SW NFET Leakage Current	$V_{EN} = 0V$ ; $V_{IN} = 6V$ ; $V_{SW} = 6V$	-5	1.5	5	$\mu A$
SW PFET Peak Current Limit	Duty Cycle = 100%, Current Pulse Width < 1mS	1.7	2.2		A
Oscillator Frequency		1.3	1.5	1.7	MHz

**Note:**

 4) Production test at  $+25^{\circ}C$ . Specifications over the temperature range are guaranteed by design and characterization.

**PIN FUNCTIONS**

Pin #	Name	Description
1	FB	Feedback input.
2	PGOOD	Power-good indicator output. "Open-drain" output indicating that the output is within 10% of the final regulation value. "Low" output indicates output is more than 10% lower than regulation level. PGOOD is pulled down in shutdown. PGOOD comparator shall have 200us deglitch timer to avoid false trigger during transition of operation modes.
3	GND	Ground pin.
4	SW	Switch node to the inductor.
5	IN	Input supply pin.
6	CTRL	Input to control the operation mode. "High" set MP2113 in forced PWM mode, DRN=Low (Pull Down) and "Low" sets MP2113 in low power asynchronous mode, DRN=High. CTRL is pulled up to $V_{IN}$ with 1uA current.
7	EN	Enable input, "High" enables MP2113. EN is pulled to GND with 1Meg internal resistor.
8	DRN	Drain output of an internal switch, controlled by CTRL input. DRN is open circuit when CTRL is "low", and DRN is pulled to ground with on resistance less than 100ohm when CTRL is "high".

## TYPICAL PERFORMANCE CHARACTERISTICS

$V_{IN} = 6V$ ,  $V_{OUT} = 1.8V$ ,  $L=2.2\mu H$ ,  $T_A = +25^\circ C$ , PWM Mode, unless otherwise noted.

Efficiency vs. Load Current

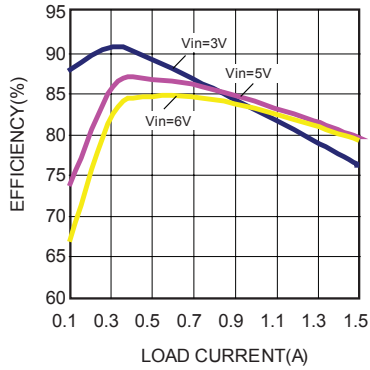

Enabled Supply Current vs. Input Voltage

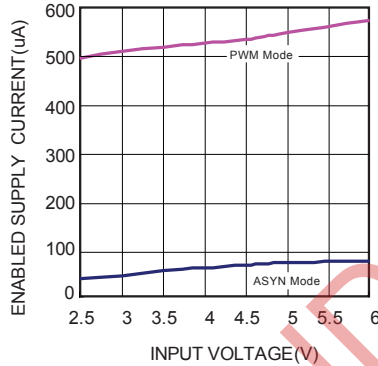

Disabled Supply Current vs. Input Voltage

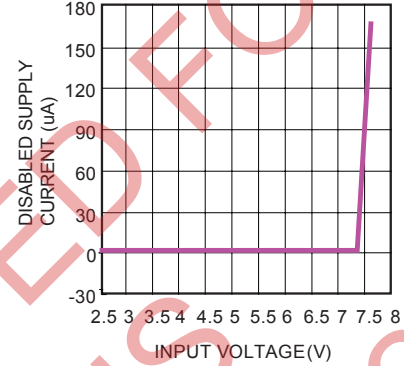

Case Temperature Rise vs. Output Current

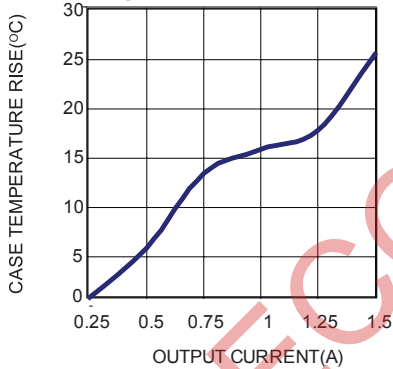

Operating Range

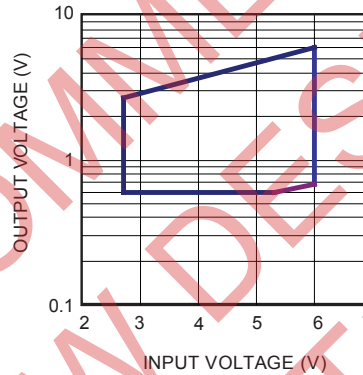

Load Regulation

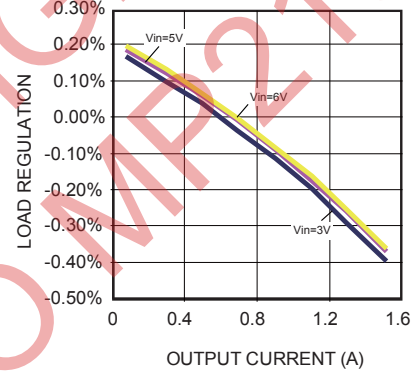

Line Regulation

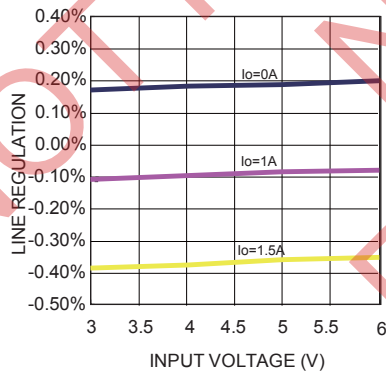

Peak Current vs. Duty



**TYPICAL PERFORMANCE CHARACTERISTICS (continued)**

$V_{IN} = 6V$ ,  $V_{OUT} = 1.8V$ ,  $L=2.2\mu H$ ,  $T_A = +25^\circ C$ , PWM Mode, unless otherwise noted.

**Output Short**

$I_{OUT}=1.5A$

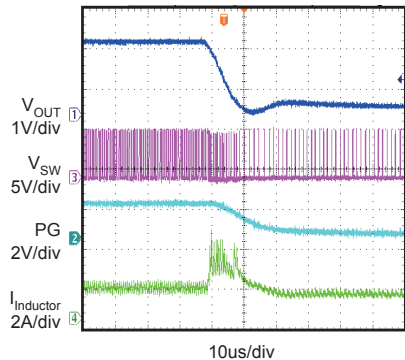

**Short Recovery**

$I_{OUT}=1.5A$

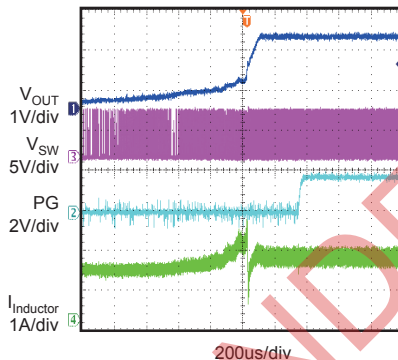

**Enable Startup**

No Load

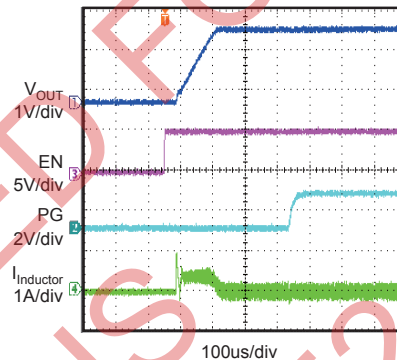

**Enable Startup**

$I_{OUT}=1.5A$

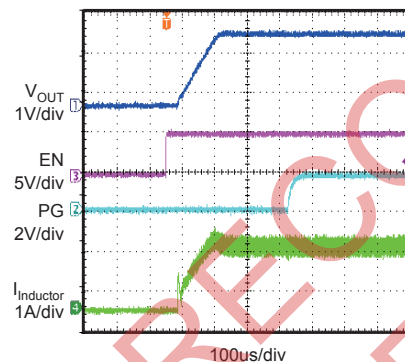

**Power up**

No Load

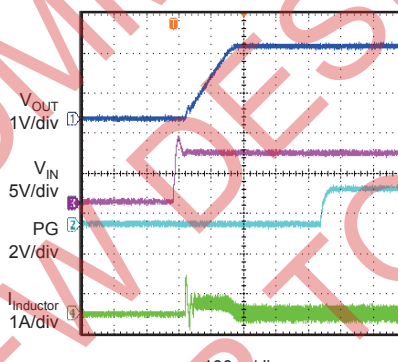

**Power up**

$I_{OUT}=1.5A$

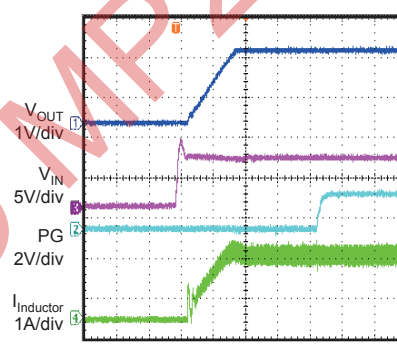

**Input Ripple Voltage**

$I_{OUT}=1.5A$

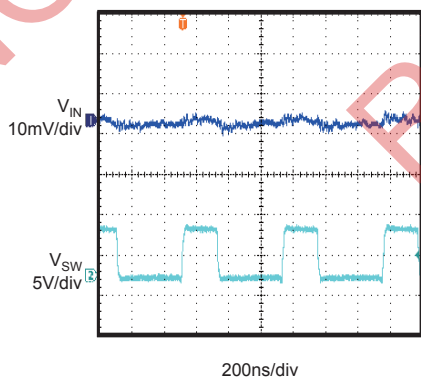

**Output Ripple Voltage**

$I_{OUT}=1.5A$

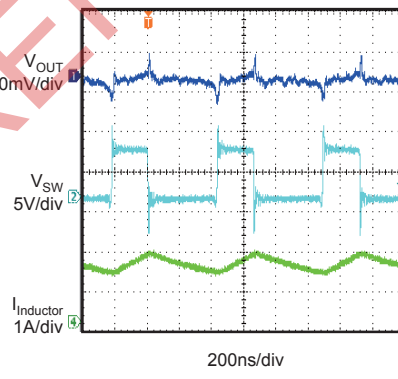

**Load Transient Response**

Load: 0.75A--1.5A, slew rate: 1A/us

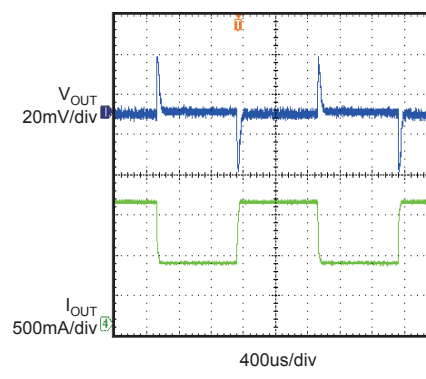

**TYPICAL PERFORMANCE CHARACTERISTICS (continued)**

$V_{IN} = 6V$ ,  $V_{OUT} = 1.8V$ ,  $L=2.2\mu H$ ,  $T_A = +25^\circ C$ , PWM Mode, unless otherwise noted.

**Output Short for ASYN Mode**  
 $V_{OUT}=0.9V$ ,  $I_{OUT}=50mA$

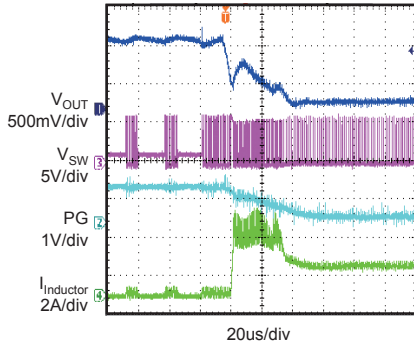

**Short Recovery for ASYN Mode**  
 $V_{OUT}=0.9V$ ,  $I_{OUT}=50mA$

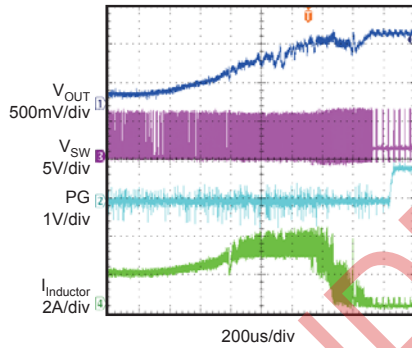

**Enable Startup for ASYN Mode**  
 $V_{OUT}=0.9V$ , No load

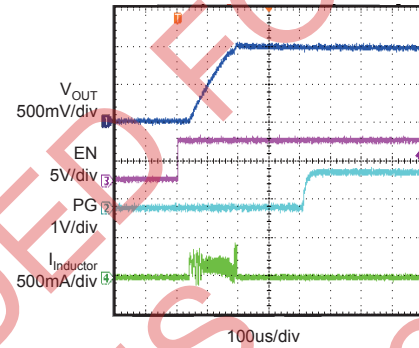

**Enable Startup for ASYN Mode**  
 $I_{OUT}=50mA$ ,  $V_{OUT}=0.9V$

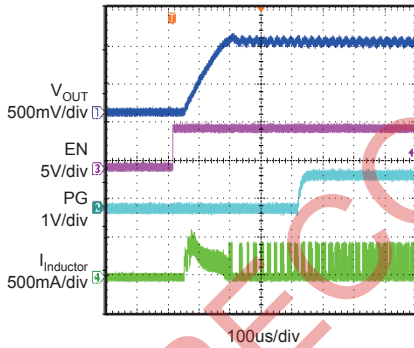

**Power up for ASYN Mode**  
 $V_{OUT}=0.9V$ , No load

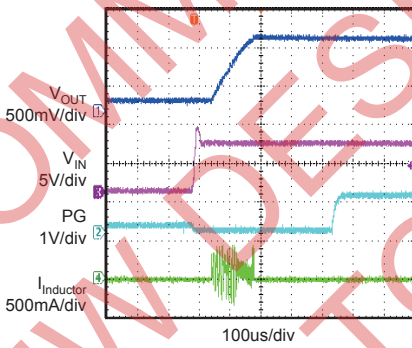

**Power up for ASYN Mode**  
 $I_{OUT}=50mA$ ,  $V_{OUT}=0.9V$

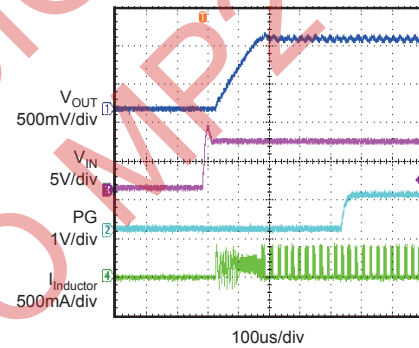

**Output Ripple Voltage for ASYN Mode**  
 $V_{OUT}=0.9V$ , No Load

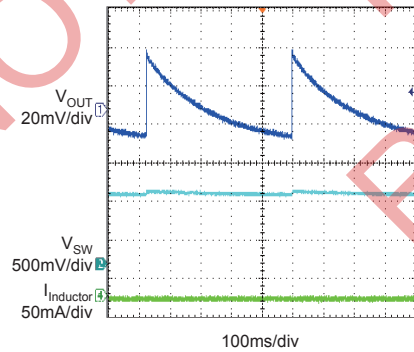

**Output Ripple Voltage for ASYN Mode**  
 $I_{OUT}=50mA$ ,  $V_{OUT}=0.9V$

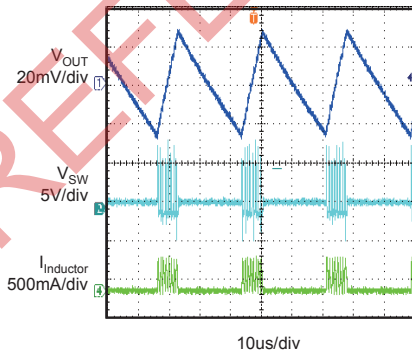

**ASYN Mode to PWM Mode**  
 $R_L=22\Omega$ ,  $V_{OUT\_PWM}=1.8V$ ,  
 $V_{OUT\_ASYN}=0.9V$

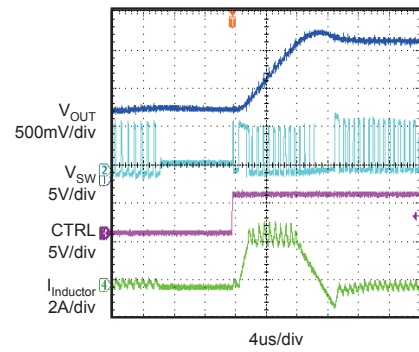

**TYPICAL PERFORMANCE CHARACTERISTICS (continued)**

$V_{IN} = 6V$ ,  $V_{OUT} = 1.8V$ ,  $L=2.2\mu H$ ,  $T_A = +25^\circ C$ , PWM Mode, unless otherwise noted.

**ASYN Mode to PWM Mode**

$R_L=22\Omega$ ,  $V_{OUT\_PWM}=0.9V$ ,  
 $V_{OUT\_ASYN}=0.9V$

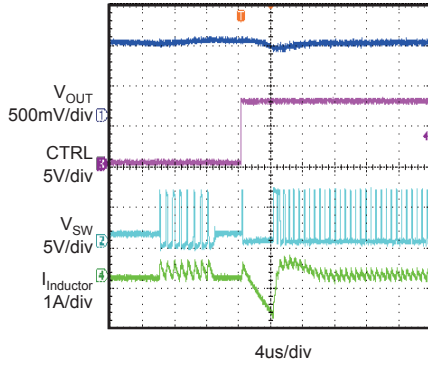

**PWM Mode to ASYN Mode**

$R_L=22\Omega$ ,  $V_{OUT\_PWM}=1.8V$ ,  
 $V_{OUT\_ASYN}=0.9V$

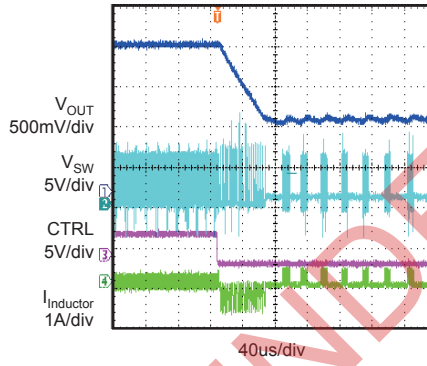

**PWM Mode to ASYN Mode**

$R_L=22\Omega$ ,  $V_{OUT\_PWM}=0.9V$ ,  
 $V_{OUT\_ASYN}=0.9V$

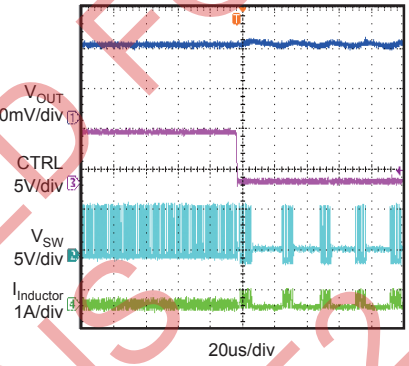

NOT RECOMMENDED FOR NEW DESIGNERS REFER TO MP2152

## OPERATION

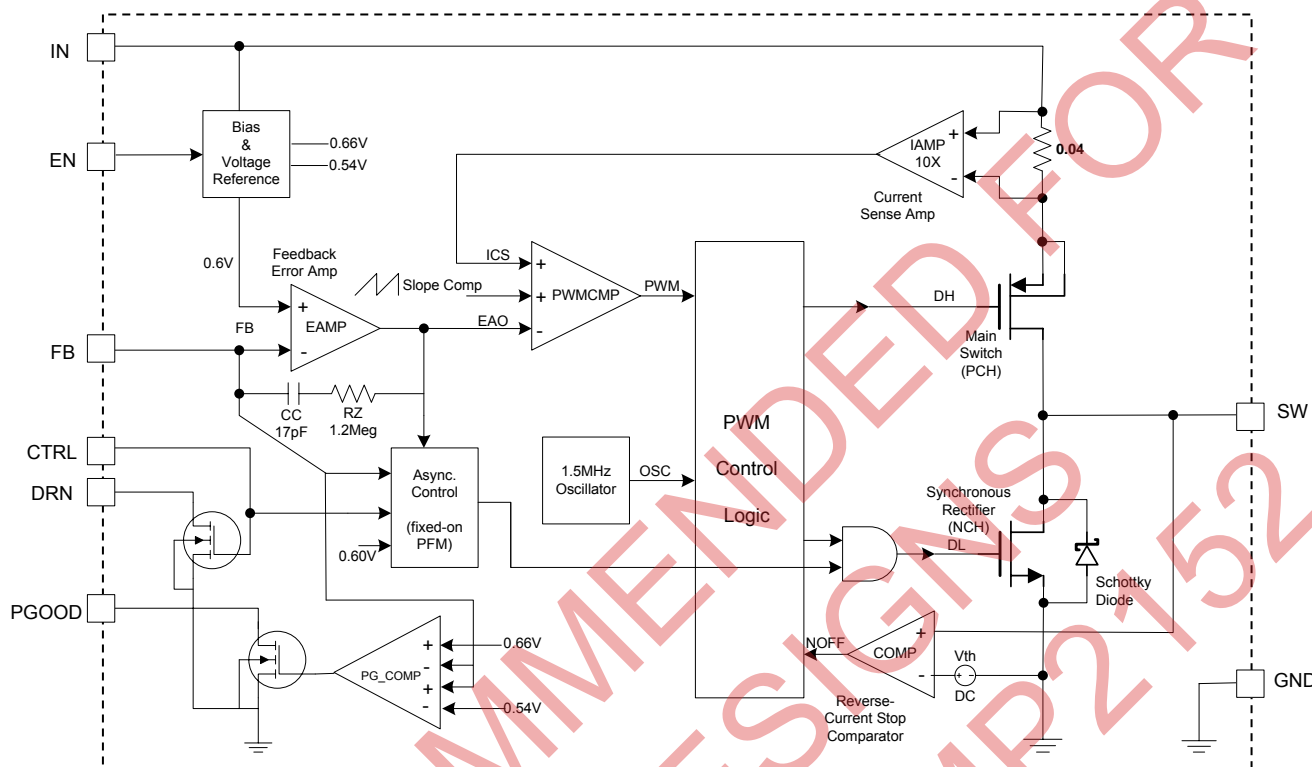

**Figure 1-Functional Block Diagram**

The MP2113 is a fixed frequency 1.5MHz current mode 1.5A step-down converter with dynamic voltage control. It has user selectable two operation modes: forced PWM mode for high load and asynchronous mode for light load. The output voltage for each mode can be set independently, through an external resistor divider and a control pin.

MP2113 is optimized for low voltage, Li-Ion battery powered applications where high efficiency and small size are critical.

### Forced PWM Mode

The forced PWM mode uses a high side PFET main switch and a low side synchronous rectifier, and always operates in continuous conduction mode. Thus it simplifies the control scheme and eliminates the random spectrum noise due to discontinuous conduction mode.

The steady state duty cycle D for this mode can be calculated as:

$$D = T_{ON} \times f_{OSC} \times 100\% \approx \frac{V_{OUT}}{V_{IN}} \times 100\%$$

Where  $T_{ON}$  is the main switch on time and  $f_{OSC}$  is the oscillator frequency (1.5MHz typ.).

### Current Mode PWM Control

Slope compensated current mode PWM control provides stable switching and cycle-by-cycle current limiting for superior load and line response as well as protection of the internal main switch and synchronous rectifier. The MP2113 switches at a constant frequency (1.5MHz) and modulates the inductor peak current to regulate the output voltage. Specifically, for each cycle the PWM controller forces the inductor peak current to an internal reference level derived from the feedback error voltage. At normal operation, the main switch is turned on at each rise edge of the internal oscillator, and remains on for a certain period of time to ramp up the inductor current. As soon as the inductor current reaches the reference level, the main switch is turned off and immediately the synchronous rectifier will be turned on to provide the inductor current. In forced PWM mode, the synchronous rectifier will stay on until the next oscillator cycle.



### Dropout Operation

The MP2113 allows the main switch to remain on for more than one switching cycle to increase the duty cycle when the input voltage is dropping close to the output voltage. When the duty cycle reaches 100%, the main switch is held on continuously to deliver current to the output up to the PFET current limit. In this case, the output voltage becomes the input voltage minus the voltage drop across the main switch and the inductor.

### Short Circuit Protection

When the output is shorted to ground, the oscillator frequency is reduced to prevent the inductor current from increasing beyond the PFET current limit. The PFET current limit is also reduced to lower the short circuit current. The frequency and current limit will return to the normal values once the short circuit condition is removed and the feedback voltage approaches 0.6V.

### Maximum Load Current

The MP2113 can operate down to 2.7V input voltage; however the maximum load current decreases at lower input due to a large IR drop on the main switch and synchronous rectifier. The slope compensation signal reduces the peak inductor current as a function of the duty cycle to prevent sub-harmonic oscillations at duty cycles greater than 50%. Conversely, the current limit increases as the duty cycle decreases.

### Asynchronous Mode Operation

To improve efficiency at light load condition, user can set MP2113 to operate in asynchronous mode. The maximum load current for this mode is designed to be around 50mA.

### Mode Switching

User can switch between the two operation modes for MP2113 by toggling the CTRL input pin on the fly. Bring CTRL high will put MP2113 in forced PWM mode and low will put MP2113 in asynchronous mode. CTRL pin can also be used to change the feedback resistor divider ratio, through an open-drain output DRN pin. Bring CTRL high will connect DRN to ground through a low resistance (<100Ω) switch; Bring CTRL low will put DRN pin to open circuit. User can simply connect a third resistor between feedback pin and DRN pin, to get a higher output level for

forced PWM mode and a lower level for asynchronous mode. MP2113 is designed to optimally ramp up and down the output voltage when CTRL changes state. Typically it takes about 10μs to ramp up the voltage and 30μs to ramp down the voltage.

### PGOOD Indicator

MP2113 provides an open-drain PGOOD output that goes high after output level reaches regulation during startup. During mode switching where the output voltage level could be changed, there is a 200us de-glitch time on PGOOD to allow the output to settle to the desired level, and to avoid false trigger. PGOOD goes low if the output goes out of regulation by ±10% and the de-glitch times out, or when device enters shutdown.

## APPLICATION INFORMATION

### Output Voltage Setting

The external resistor divider sets the output voltage. The resistor R1 also sets the feedback loop bandwidth for the step-down converter. (see Figure 1).

Choose R1 to be between 200k-300kΩ for optimal transient response. R2 is calculated using the desired output voltage for asynchronous mode:

$$R2 = \frac{R1}{\frac{V_{OUT\_ASYNC}}{0.6V} - 1}$$

R3 is then calculated using R1, R2 and the desired output voltage for forced PWM mode:

$$R3 = \frac{R1 \parallel R2}{\frac{V_{OUT\_FPWM}}{0.6V} - 1} \cdot \frac{R2}{R1 + R2}$$

If one want to have the same output voltage level for both operation mode, R3 will not be needed.

**Table 1—Resistor Selection vs. Output Voltage Setting**

V <sub>O_ASYNC</sub> /V <sub>O_FPWM</sub>	R1	R2	R3
0.9V/1.8V	301kΩ (1%)	604kΩ (1%)	200kΩ (1%)
1.2V/1.8V	301kΩ (1%)	301kΩ (1%)	301kΩ (1%)
1.2V/2.5V	301kΩ (1%)	301kΩ (1%)	137kΩ (1%)
1.5V/3.3V	301kΩ (1%)	200kΩ (1%)	100kΩ (1%)

### Inductor Selection

A 1μH to 10μH inductor with DC current rating at least 25% higher than the maximum load current is recommended for most applications. For best efficiency, the inductor DC resistance shall be <200mΩ. For most designs, the inductance value can be derived from the following equation:

$$L = \frac{V_{OUT} \times (V_{IN} - V_{OUT})}{V_{IN} \times \Delta I_L \times f_{OSC}}$$

Where ΔI<sub>L</sub> is inductor ripple current. Choose inductor ripple current approximately 30% of the maximum load current, 1.5A.

The maximum inductor peak current is:

$$I_{L(MAX)} = I_{LOAD} + \frac{\Delta I_L}{2}$$

**Table 2—Suggested Inductors**

Manufacturer	Part Number	Inductance (μH)	Dimensions LxWxH (mm <sup>3</sup> )
Wurth	7447745022	2.2	5.8X5.2X2
Toko	636CY-2R2M	2.2	6.8X6X3.5
TDK	VLCF5020T-2R2N2R6-1	2.2	5X5X2

### Input Capacitor C<sub>IN</sub> Selection

The input capacitor reduces the surge current drawn from the input and switching noise from the device. Ceramic capacitors with X5R or X7R dielectrics are highly recommended because of their low ESR and small temperature coefficients. For most applications, a 4.7μF capacitor is sufficient.

### Output Capacitor C<sub>OUT</sub> Selection

The output capacitor keeps output voltage ripple small and ensures regulation loop stable. The output capacitor impedance shall be low at the switching frequency. Ceramic capacitors with X5R or X7R dielectrics are recommended. For forced PWM mode operation, the output ripple ΔV<sub>OUT</sub> is approximately:

$$\Delta V_{OUT} = \frac{V_{OUT} \cdot (V_{IN} - V_{OUT})}{V_{IN} \cdot f_{OSC} \cdot L} \left( R_{ESR} + \frac{1}{8} \cdot \frac{1}{f_{OSC} \cdot C_{OUT}} \right)$$

For asynchronous mode operation, the output ripple is the scaled amplitude of the feedback threshold hysteresis window:

$$\Delta V_{OUT} = (0.606V - 0.594V) \cdot \frac{R1 + R2}{R2}$$

### Thermal Dissipation

Power dissipation shall be considered when MP2113 operates at maximum 1.5A output current. If the junction temperature rises above 150°C, MP2113 will be shut down by internal thermal protection circuitry.

The junction-to-ambient thermal resistance of the 8-pin QFN (2mm x 3mm) R<sub>ΘJA</sub> is 50°C/W. The maximum allowable power dissipation is

about 1.6W when MP2113 is operating in a 70°C ambient temperature environment:

$$PD_{MAX} = \frac{150^{\circ}C - 70^{\circ}C}{50^{\circ}C/W} = 1.6W$$

**PCB Layout**

The high current paths (GND, IN and SW) should be placed very close to the device with short,

direct and wide traces. Input capacitors should be placed as close as possible to the respective IN and GND pins. The external feedback resistors shall be placed next to the FB pins. Keep the switching nodes SW short and away from the feedback network.

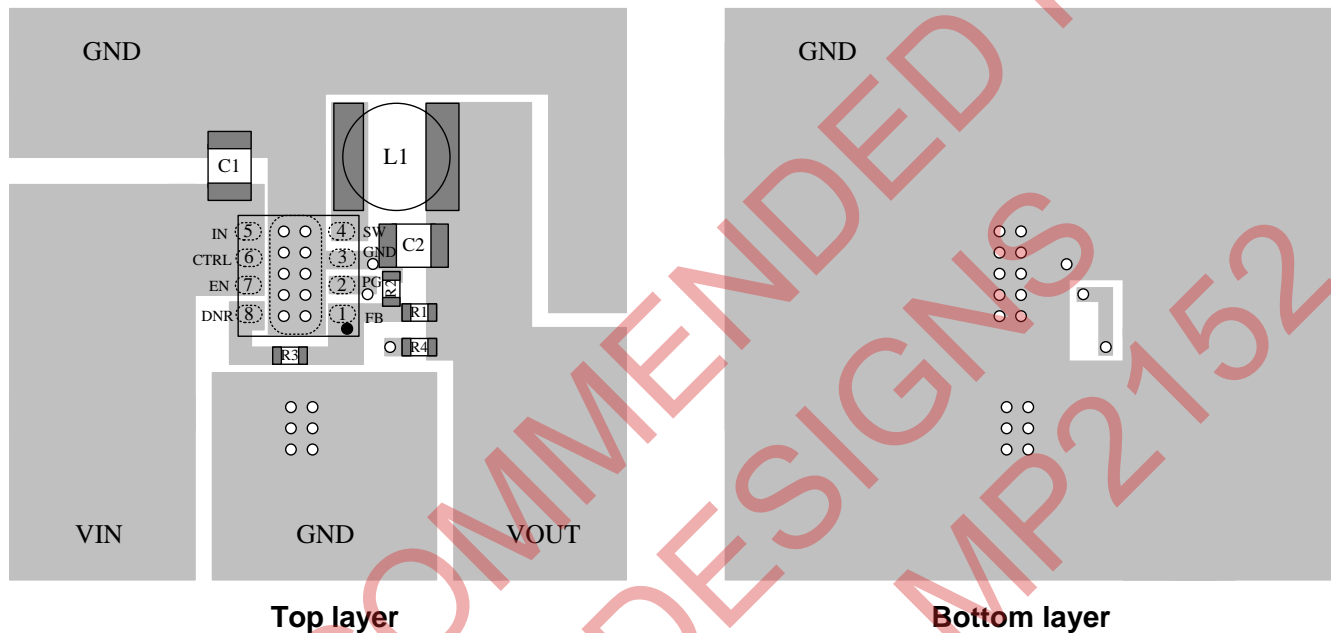

**Figure 2-PCB Layout**

## TYPICAL APPLICATION CIRCUITS

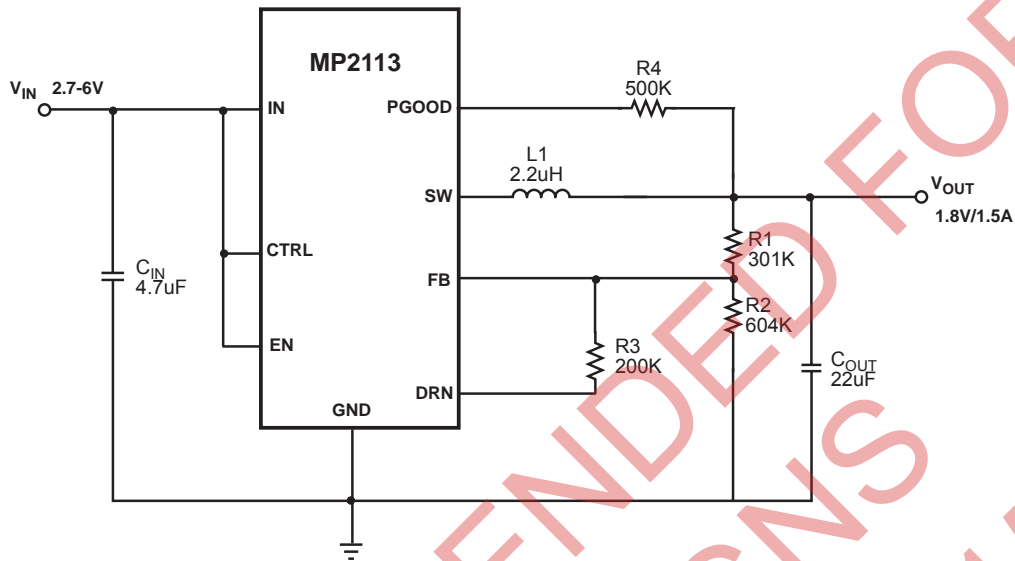
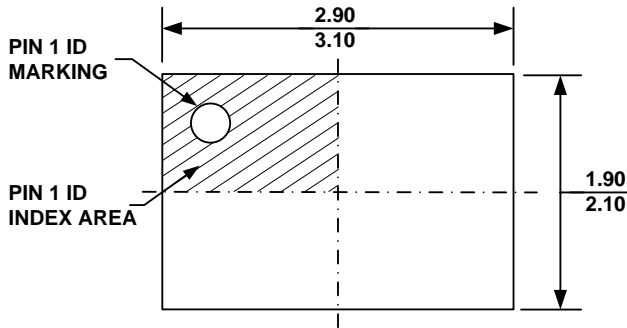

Figure 3-Typical Application Circuit

**PACKAGE INFORMATION**

**QFN8 (2mm x 3mm)**



**TOP VIEW**

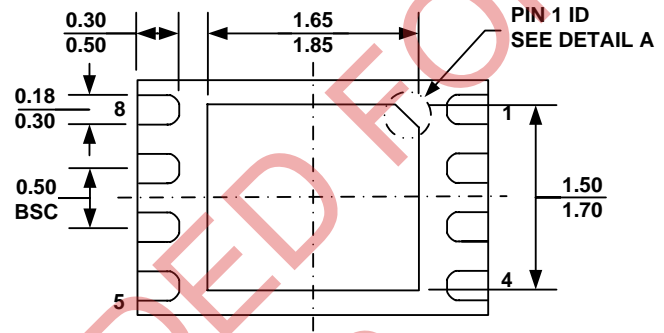

**BOTTOM VIEW**

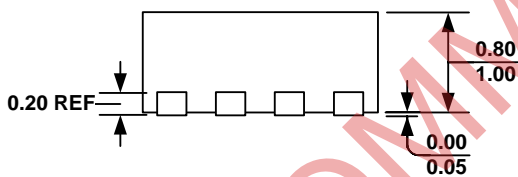

**SIDE VIEW**

**PIN 1 ID OPTION A**  
0.30x45° TYP.

**PIN 1 ID OPTION B**  
R0.20 TYP.

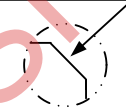

**DETAIL A**

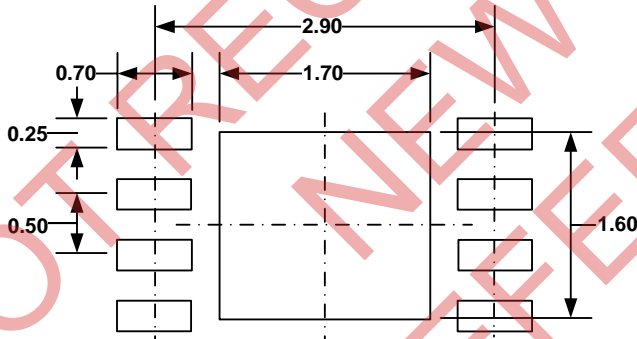

**RECOMMENDED LAND PATTERN**

**NOTE:**

- 1) ALL DIMENSIONS ARE IN MILLIMETERS.
- 2) EXPOSED PADDLE SIZE DOES NOT INCLUDE MOLD FLASH.
- 3) LEAD COPLANARITY SHALL BE 0.10 MILLIMETER MAX.
- 4) DRAWING CONFORMS TO JEDEC MO-229, VARIATION VCD-2.
- 5) DRAWING IS NOT TO SCALE.

**NOTICE:** The information in this document is subject to change without notice. Users should warrant and guarantee that third party Intellectual Property rights are not infringed upon when integrating MPS products into any application. MPS will not assume any legal responsibility for any said applications.