

DESCRIPTION

The MP2270 is a monolithic step-down switch mode converter with a built-in internal power MOSFET. It achieves 1.8A continuous output current over a wide input supply range with excellent load and line regulation. Current mode operation provides fast transient response and eases loop stabilization. Fault condition protection includes cycle-by-cycle current limiting and thermal shutdown.

The MP2270 requires a minimum number of readily available standard external components. The MP2270 is available in a 10-pin exposed pad MSOP package.

FEATURES

- 1.8A Continuous Output Current
- 0.3Ω Internal Power MOSFET Switch
- Stable with Low ESR Output Ceramic Capacitors
- 0.1μA Shutdown Mode
- Fixed 700kHz Frequency
- Thermal Shutdown
- Cycle-by-Cycle Over Current Protection
- Wide 4.5V to 24V Operating Input Range
- Output Adjustable from 0.81V to 20V
- Available in a 10-pin Exposed Pad MSOP Package

APPLICATIONS

- Broadband Communications Equipment
- Digital Entertainment Systems
- Distributed Power Systems
- Battery Charger
- Pre-Regulator for Linear Regulators

"MPS" and "The Future of Analog IC Technology" are Registered Trademarks of Monolithic Power Systems, Inc.

TYPICAL APPLICATION

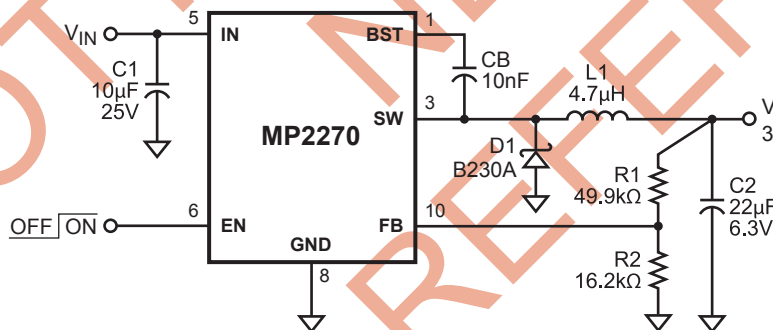

Efficiency vs
Load Current

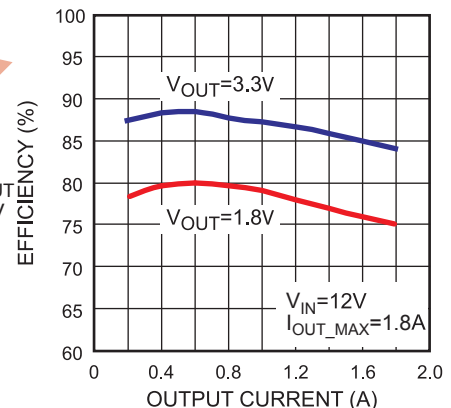

ORDERING INFORMATION

Part Number*	Package	Top Marking	Free Air Temperature (T _A)
MP2270DH	MSOP10w/Exposed Pad	2270D	-40°C to +85°C

* For Tape & Reel, add suffix -Z (e.g. MP2270DH-Z).
 For RoHS Compliant packaging, add suffix -LF (e.g. MP2270DH-LF-Z)

PACKAGE REFERENCE

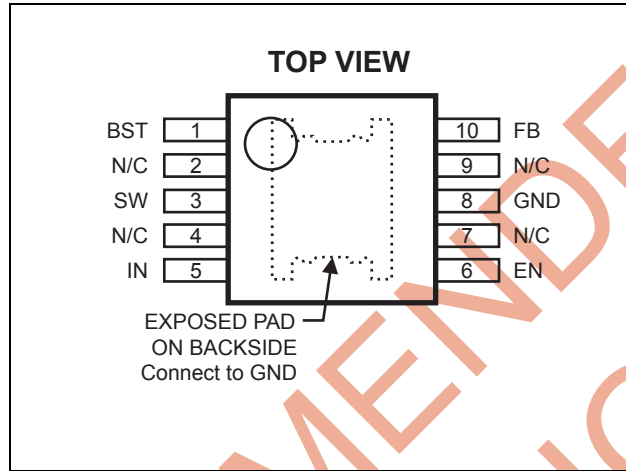

ABSOLUTE MAXIMUM RATINGS ⁽¹⁾

Supply Voltage V _{IN}	26V
V _{SW}	-0.3V to V _{IN} + 0.3V
V _{BS}	V _{SW} + 6V
All Other Pins	-0.3V to +6V
Continuous Power Dissipation (T _A = +25°C) ⁽²⁾	2.3W
Junction Temperature	150°C
Lead Temperature	260°C
Storage Temperature	-65°C to +150°C

Recommended Operating Conditions ⁽³⁾

Supply Voltage V _{IN}	4.5V to 24V
Operating Junct. Temp (T _J)	-40°C to +125°C

Thermal Resistance ⁽⁴⁾

	θ _{JA}	θ _{JC}
MSOP10 w/Exposed Pad	55	12 ... °C/W

Notes:

- Exceeding these ratings may damage the device.
- The maximum allowable power dissipation is a function of the maximum junction temperature T_J (MAX), the junction-to-ambient thermal resistance θ_{JA}, and the ambient temperature T_A. The maximum allowable continuous power dissipation at any ambient temperature is calculated by P_D (MAX) = (T_J (MAX) - T_A) / θ_{JA}. Exceeding the maximum allowable power dissipation will cause excessive die temperature, and the regulator will go into thermal shutdown. Internal thermal shutdown circuitry protects the device from permanent damage.
- The device is not guaranteed to function outside of its operating conditions.
- Measured on JESD51-7, 4-layer PCB.

ELECTRICAL CHARACTERISTICS
 $V_{IN} = 12V$, $T_A = +25^{\circ}C$, unless otherwise noted.

Parameters	Symbol	Condition	Min	Typ	Max	Units
Feedback Voltage	V_{FB}	$4.5V \leq V_{IN} \leq 24V$	0.790	0.810	0.830	V
Feedback Current	I_{FB}	$V_{FB} = 0.8V$		10		nA
Switch On-Resistance ⁽⁵⁾	$R_{DS(ON)}$			0.3		Ω
Switch Leakage		$V_{EN} = 0V$, $V_{SW} = 0V$		0	10	μA
Current Limit ⁽⁵⁾		Duty Cycle = 40%	2.0	2.5		A
Oscillator Frequency	f_{SW}	$V_{FB} = 0.6V$		700		kHz
Fold-back Frequency		$V_{FB} = 0V$		230		kHz
Maximum Duty Cycle		$V_{FB} = 0.6V$		87		%
Minimum On-Time ⁽⁵⁾	t_{ON}			100		ns
Under-Voltage Lockout Threshold Rising			2.5	2.8	3.1	V
Under-Voltage Lockout Threshold Hysteresis				150		mV
EN Input Low Voltage					0.4	V
EN Input High Voltage			1.5			V
EN Input Current		$V_{EN} = 2V$		2.1		μA
		$V_{EN} = 0V$		0.01		
Supply Current (Shutdown)		$V_{EN} = 0V$		0.1	1.0	μA
Supply Current (Quiescent)		$V_{EN} = 2V$, $V_{FB} = 1V$		0.8	1.0	mA
Thermal Shutdown ⁽⁵⁾				150		$^{\circ}C$

Note:

5) Guaranteed by design.

PIN FUNCTIONS

Pin #	Name	Description
2, 4, 9, 7	NC	No Connect.
3	SW	Switch Output.
5	IN	Supply Voltage. The MP2270 operates from a +4.5V to +24V unregulated input. C1 is needed to prevent large voltage spikes from appearing at the input.
6	EN	On/Off Control Input. Pull above 1.2V to turn the device on.
10	FB	Feedback. An external resistor divider from the output to GND, tapped to the FB pin sets the output voltage. To prevent current limit run away during a short circuit fault condition the frequency foldback comparator lowers the oscillator frequency when the FB voltage is below 250mV.
8	GND, Exposed pad	Ground. This pin is the voltage reference for the regulated output voltage. For this reason care must be taken in its layout. This node should be placed outside of the D1 to C1 ground path to prevent switching current spikes from inducing voltage noise into the part. Exposed pad must be connected to a ground plane for proper thermal operation.
1	BST	Bootstrap. This capacitor is needed to drive the power switch's gate above the supply voltage. It is connected between SW and BST pins to form a floating supply across the power switch driver.

TYPICAL PERFORMANCE CHARACTERISTICS

$V_{IN} = 12V$, $V_{OUT} = 1.8V$, $L=6.8\mu H$, $I_{LOAD}=0.5A - 1.8A$, $T_A = +20^\circ C$, unless otherwise noted.

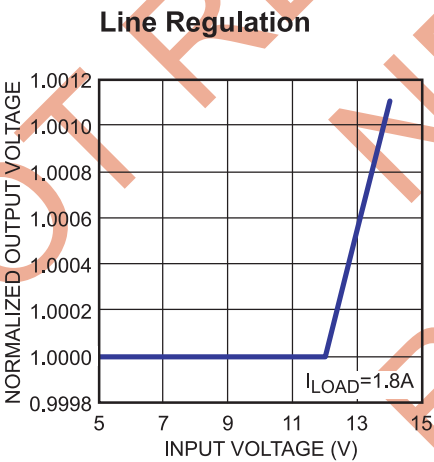
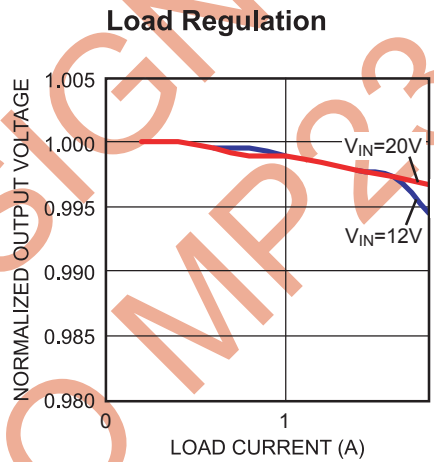
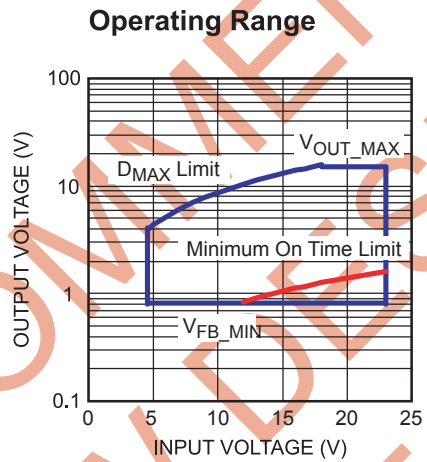
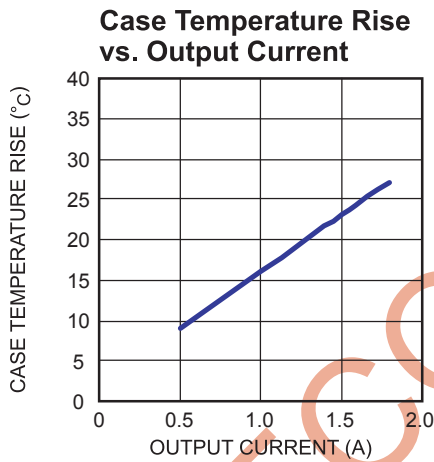
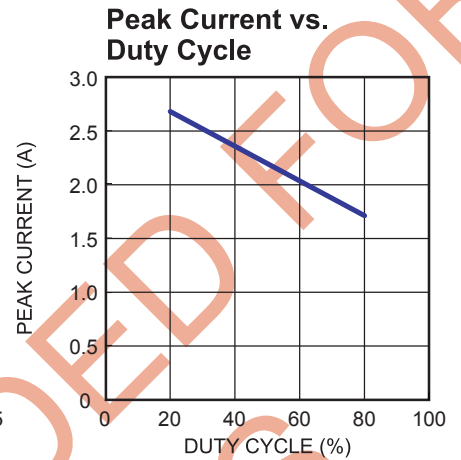
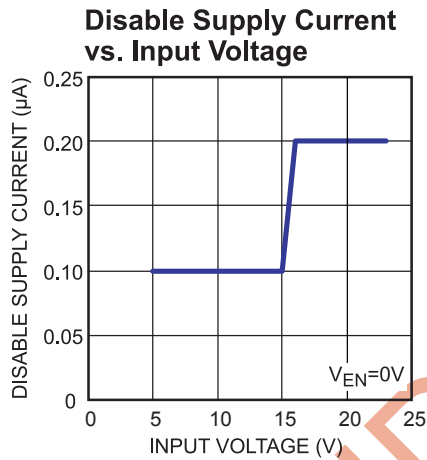
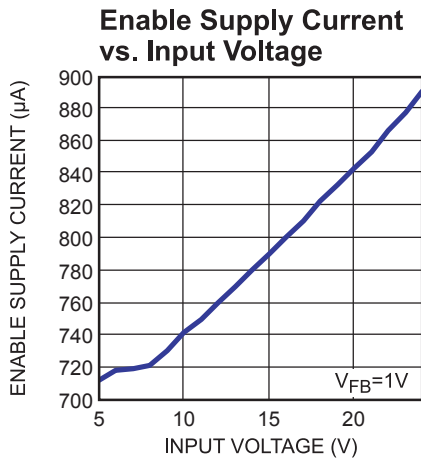

TYPICAL PERFORMANCE CHARACTERISTICS *(continued)*

$V_{IN} = 12V$, $V_{OUT} = 1.8V$, $L=6.8\mu H$, $I_{LOAD}=0.5A - 1.8A$, $T_A = +20^\circ C$, unless otherwise noted.

Hiccup with Output Short Circuit

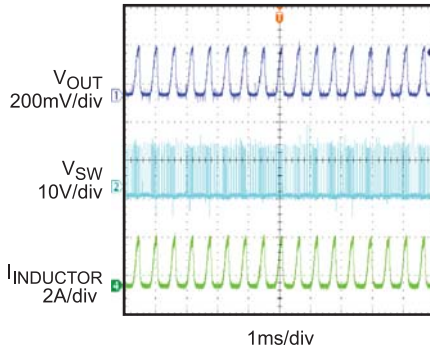

Power Up No Load

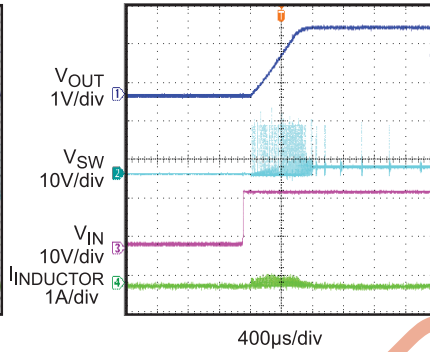

Power Up Full Load

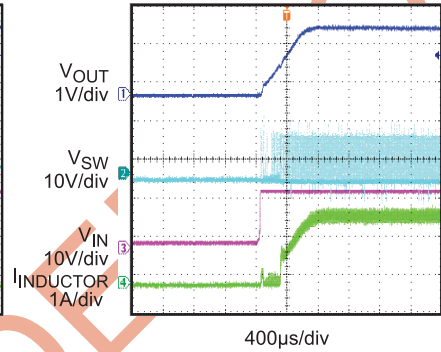

Enable Startup No Load

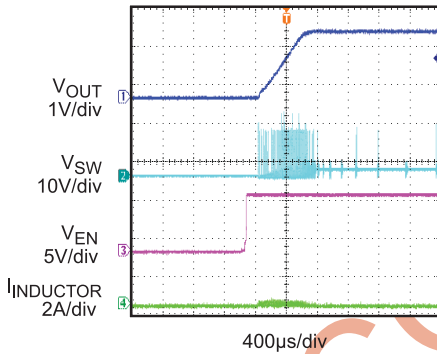

Enable Startup Full Load

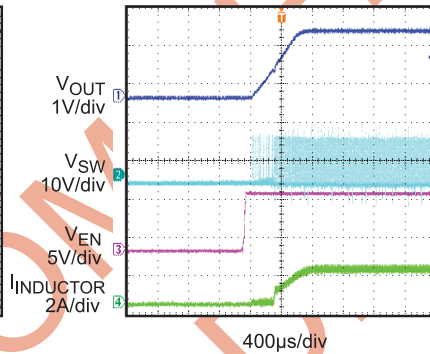

Input Ripple Voltage
 $I_{OUT}=1.8A$

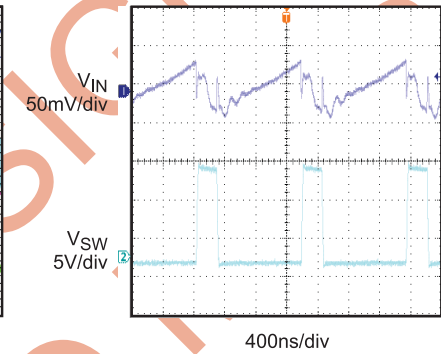

Output Ripple Voltage
 $I_{OUT}=1.8A$

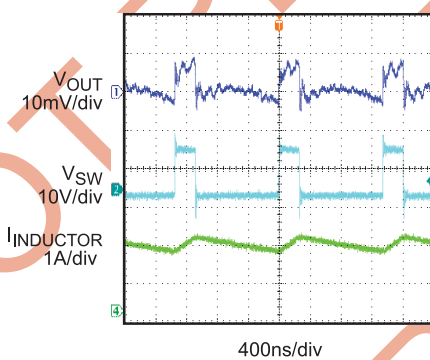

Load Transient Response

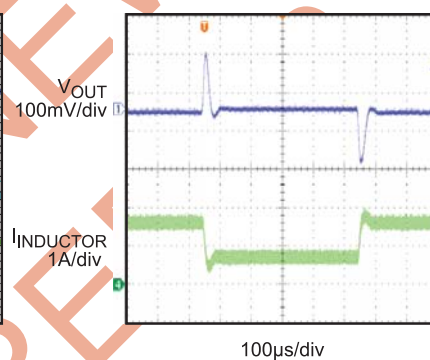

OPERATION

The MP2270 is a current mode buck regulator. That is, the EA output voltage is proportional to the peak inductor current.

At the beginning of a cycle, M1 is off. The EA output voltage is higher than the current sense amplifier output, and the current comparator's output is low. The rising edge of the 700KHz CLK signal sets the RS Flip-Flop. Its output turns on M1 thus connecting the SW pin and inductor to the input supply.

The increasing inductor current is sensed and amplified by the Current Sense Amplifier. Ramp compensation is summed to Current Sense Amplifier output and compared to the Error Amplifier output by the PWM Comparator. When the sum of the Current Sense Amplifier output and the Slope Compensation signal exceeds the EA output voltage, the RS Flip-Flop is reset and the M1 is turned off. The external Schottky rectifier diode (D1) conducts the inductor current.

If the sum of the Current Sense Amplifier output and the Slope Compensation signal does not exceed the EA output for a whole cycle, then the falling edge of the CLK resets the Flip-Flop.

The output of the Error Amplifier integrates the voltage difference between the feedback and the 0.81V bandgap reference. The polarity is such that a FB pin voltage lower than 0.8V increases the EA output voltage. Since the EA output voltage is proportional to the peak inductor current, an increase in its voltage also increases current delivered to the output.

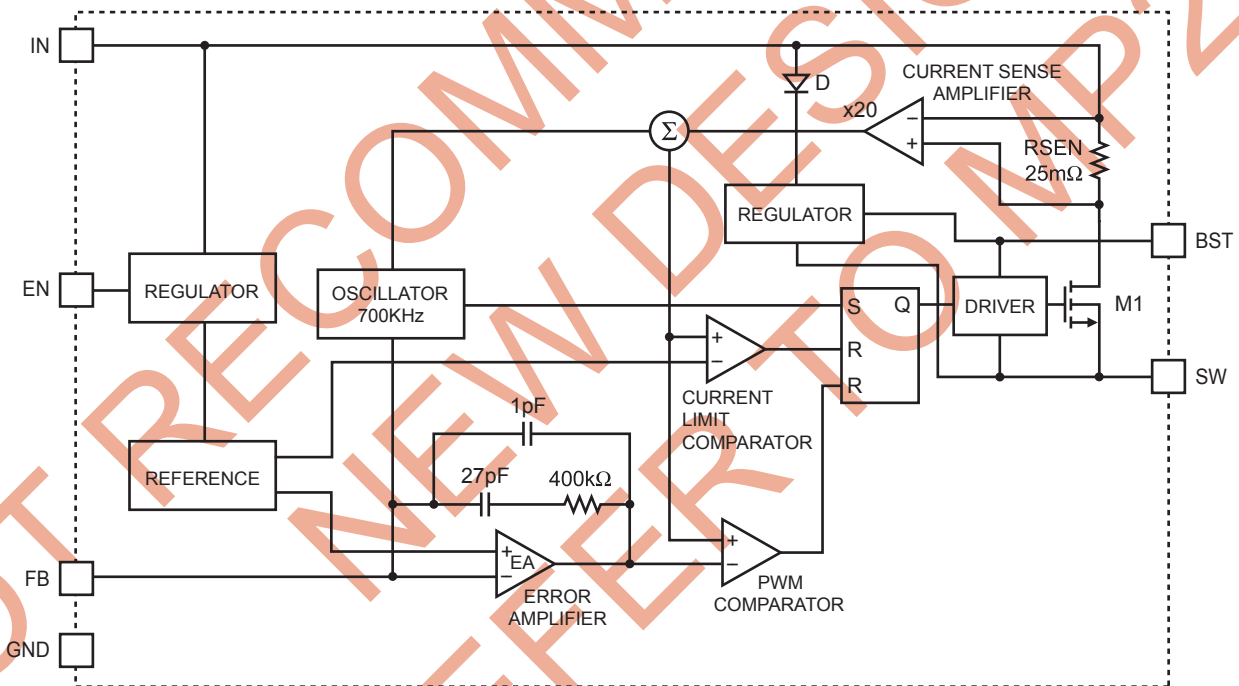

Figure 1—Functional Block Diagram

APPLICATION INFORMATION

Setting Output Voltage

The external resistor divider is used to set the output voltage (see the schematic on front page). The feedback resistor R1 also sets the feedback loop bandwidth with the internal compensation capacitor (see Figure 1). R2 can be determined by:

$$R2 = \frac{R1}{\frac{V_{OUT}}{0.81V} - 1}$$

Table 1—Resistor Selection for Common Output Voltages

V _{OUT} (V)	R1 (kΩ)	R2 (kΩ)
1.8	80.6 (1%)	64.9 (1%)
2.5	49.9 (1%)	23.7 (1%)
3.3	49.9 (1%)	16.2 (1%)
5	49.9 (1%)	9.53 (1%)

Selecting the Inductor

A 1μH to 10μH inductor with a DC current rating of at least 25% percent higher than the maximum load current is recommended for most applications. For highest efficiency, the inductor's DC resistance should be less than 200mΩ. For most designs, the required inductance value can be derived from the following equation.

$$L = \frac{V_{OUT} \times (V_{IN} - V_{OUT})}{V_{IN} \times \Delta I_L \times f_{OSC}}$$

Where ΔI_L is the inductor ripple current.

Choose an inductor with a rating current of approximately 30% higher than the maximum load current if the maximum load current is ≥1.8A. The maximum inductor peak current is calculated from:

$$I_{L(MAX)} = I_{LOAD} + \frac{\Delta I_L}{2}$$

Under light load conditions below 100mA, a larger inductance is recommended for improved efficiency. See Table 2 for suggested inductors.

Selecting the Input Capacitor

The input capacitor reduces the surge current drawn from the input and the switching noise from the device. The input capacitor impedance at the switching frequency should be less than the input source impedance to prevent high frequency switching current from passing through the input. Ceramic capacitors with X5R or X7R dielectrics are highly recommended because of their low ESR and small temperature coefficients. For most applications, a 10μF capacitor is sufficient.

Selecting the Output Capacitor

The output capacitor keeps output voltage ripple small and ensures loop stability. The output capacitor impedance should be low at the switching frequency. Ceramic capacitors with X5R or X7R dielectrics are recommended for their low ESR characteristics. For most applications, a 22μF ceramic capacitor will be sufficient.

PC Board Layout

The high current paths (GND, IN and SW) should be placed very close to the device with short, direct and wide traces. The input capacitor needs to be as close as possible to the IN and GND pins. The external feedback resistors should be placed next to the FB pin. Keep the switch node traces short and away from the feedback network.

External Bootstrap Diode

An external bootstrap diode may enhance the efficiency of the regulator, the applicable conditions of external BST diode are:

- $V_{OUT}=5V$ or $3.3V$; and
- Duty cycle is high: $D = \frac{V_{OUT}}{V_{IN}} > 65\%$

In these cases, an external BST diode is recommended from the output of the voltage regulator to BST pin, as shown in Fig.2

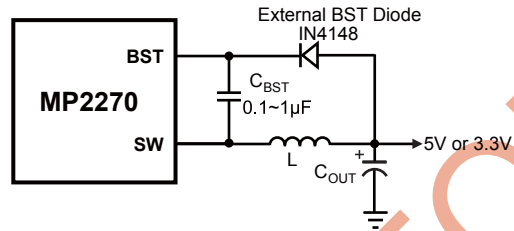

Figure 2—Add Optional External Bootstrap Diode to Enhance Efficiency

The recommended external BST diode is IN4148, and the BST cap is 0.1~1µF.

Table 2—Suggested Surface Mount Inductors

Manufacturer	Part Number	Inductance(µH)	Max DCR(Ω)	Current Rating (A)	Dimensions L x W x H (mm ³)
Würth Electronics	7447785004	4.7	0.060	2.5	5.9 x 6.2 x 3.3
Toko	A916CY-4R7M	4.7	0.026	2.5	6.2 x 6.3 x 3.5
Coiltronics	DR73-4R7	4.7	0.03	3	6.0 x 7.6 x 3.5

PACKAGE INFORMATION

MSOP 10 (EXPOSED PAD)

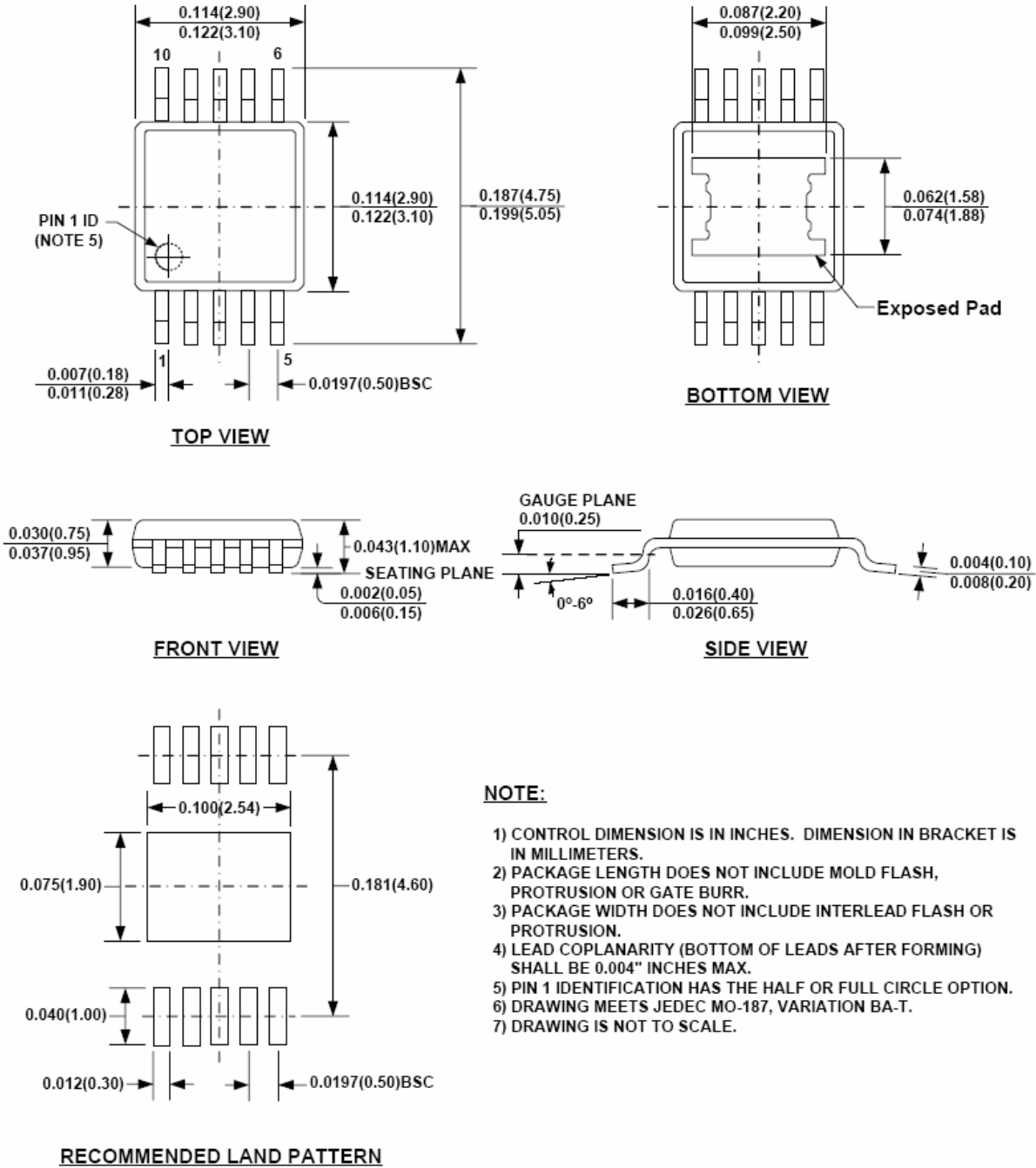

NOTICE: The information in this document is subject to change without notice. Users should warrant and guarantee that third party Intellectual Property rights are not infringed upon when integrating MPS products into any application. MPS will not assume any legal responsibility for any said applications.