

DESCRIPTION

The MP4566 is a high frequency (1MHz) step-down switching regulator with integrated internal high-side high voltage power MOSFET. It provides single 0.6A (or less) highly efficient output with current mode control for fast loop response.

The wide 4.5V to 36V input range accommodates a variety of step-down applications in automotive input environment. The very low shutdown mode quiescent current allows use in battery-powered applications.

High power conversion efficiency over a wide load range is achieved by scaling down the switching frequency at light load condition to reduce the switching and gate driving losses.

Frequency fold-back helps prevent inductor current runaway during start-up. Thermal shutdown provides reliable, fault-tolerant operation.

The MP4566 is available in a 2mmx3mm QFN8 package.

FEATURES

- 35µA Quiescent Current
- Low Shutdown Mode Current: <2µA
- Wide 4.5V to 36V Operating Input Range
- 450mΩ Internal Power MOSFET
- Fixed 1MHz Switching Frequency
- Internally compensated
- Stable with Ceramic Output Capacitors
- Internal Soft-Start
- Precision Current Limit Without Current Sensing Resistor
- High Light Load Efficiency up to 77% at 1mA
- +1.0V FB Reference Voltage
- Output Adjustable from +1.0V to 0.8xV_{IN}
- 2mmx3mm QFN8 Package

APPLICATIONS

- Adapter-Based/Handheld Applications
- Notebook/Netbook PCs
- Automotive Systems
- Industrial Power Systems
- Distributed Power Systems
- Battery Powered Systems

All MPS parts are lead-free, halogen free, and adhere to the RoHS directive. For MPS green status, please visit MPS website under Quality Assurance. "MPS" and "The Future of Analog IC Technology" are Registered Trademarks of Monolithic Power Systems, Inc.

TYPICAL APPLICATION

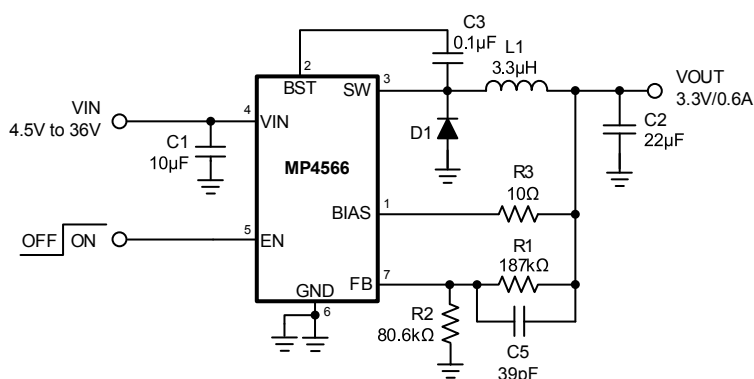

Efficiency vs. Load Current

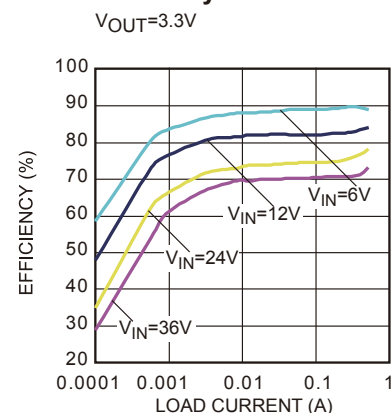

ORDERING INFORMATION

Part Number	Package	Top Marking	Free Air Temperature (T _A)
MP4566DD	QFN8 (2mmx3mm)	See Below	-40°C to +85°C

* For Tape & Reel, add suffix -Z (eg. MP4566DD-Z);
 For RoHS, compliant packaging, add suffix -LF (eg. MP4566DD-LF-Z).

TOP MARKING

5PYW
LLL

5P: product code of MP4566DD;
 Y: year code;
 W: week code;
 LLL: lot number;

PACKAGE REFERENCE

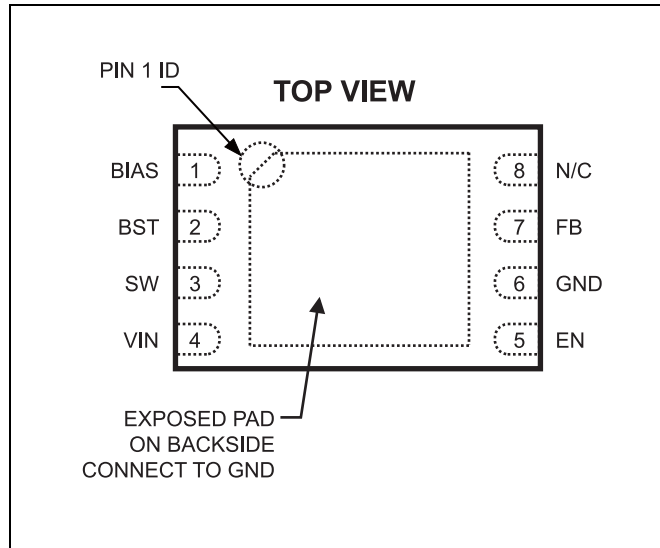

ABSOLUTE MAXIMUM RATINGS ⁽¹⁾

Supply Voltage (V_{IN}).....	-0.3V to 40V
Switch Voltage (V_{SW}).....	-0.3V to $V_{IN}+0.3V$
BST to SW	-0.3 to 5.0V
All Other Pins	-0.3V to 5.0V
Continuous Power Dissipation ($T_A = +25^{\circ}C$) ⁽²⁾	1.6W
Junction Temperature	150 $^{\circ}C$
Lead Temperature	260 $^{\circ}C$
Storage Temperature.....	-65 $^{\circ}C$ to 150 $^{\circ}C$

Recommended Operating Conditions ⁽³⁾

Supply Voltage V_{IN}	4.5V to 36V
Output Voltage V_{OUT}	+1.0V to 0.8* V_{IN}
Maximum Junction Temp. (T_J).....	+125 $^{\circ}C$

Thermal Resistance ⁽⁴⁾	θ_{JA}	θ_{JC}
QFN8(2mmx3mm).....	80	16... $^{\circ}C/W$

Notes:

- 1) Exceeding these ratings may damage the device.
- 2) The maximum allowable power dissipation is a function of the maximum junction temperature T_J (MAX), the junction-to-ambient thermal resistance θ_{JA} , and the ambient temperature T_A . The maximum allowable continuous power dissipation at any ambient temperature is calculated by P_D (MAX) = $(T_J$ (MAX)- T_A)/ θ_{JA} . Exceeding the maximum allowable power dissipation will cause excessive die temperature, and the regulator will go into thermal shutdown. Internal thermal shutdown circuitry protects the device from permanent damage.
- 3) The device is not guaranteed to function outside of its operating conditions.
- 4) Measured on approximately 1" square of 1 oz copper.

ELECTRICAL CHARACTERISTICS

$V_{IN} = 12V$, $V_{EN} = 2V$, $T_A = 25^{\circ}C$, unless otherwise noted.

Parameter	Condition	Min	Typ	Max	Units
Feedback Voltage	$4.5V < V_{IN} < 36V$	0.97	1.0	1.03	V
Upper Switch On Resistance	$V_{BST} - V_{SW} = 5V$		450		mΩ
Upper Switch Leakage	$V_{EN} = 0V$, $V_{SW} = 0V$			1	µA
Current Limit		0.8	1.2	1.6	A
VIN UVLO Up Threshold			4.0	4.2	V
VIN UVLO Hysteresis			0.4		V
Soft-start time	FB from 0 to 1.8V		0.5		ms
Oscillator Frequency		800	1000	1200	kHz
Minimum Switch On Time			100		ns
Shutdown Supply Current	$V_{EN} < 0.3V$		2	5	µA
Supply Quiescent Current	No load, $V_{FB} = 1.3$		35	45	µA
Thermal Shutdown			150		°C
Enable High Threshold	Low-to-High			1.8	V
Enable Low Threshold	High-to-Low	1.15			V

PIN FUNCTIONS

Pin #	Name	Description
1	BIAS	Controller bias input. When $V_{bias} > 2.9V$, this rail will supply current to the internal circuitries.
2	BST	Bootstrap. This is the positive power supply for the internal floating high side MOSFET driver. Connect a bypass capacitor between this pin and SW pin.
3	SW	Switch node. This is the output from the high-side switch. A low V_F Schottky diode to ground is required close to this pin to reduce switching spikes.
4	VIN	Input Supply. This supplies power to all the internal control circuitry, both BST regulators and the high side switch. A decoupling capacitor to ground is required close to this pin to reduce switching spikes.
5	EN	Enable input. Pulling this pin below the specified threshold shuts the chip down. Pulling it above the specified threshold enables the chip. Floating this pin automatically keeps the MP4566 on.
6	GND	Ground. It should be connected as close as possible to the output capacitor avoiding the high current switch paths.
7	FB	Feedback. This is the input to the error amplifier. An external resistive divider connected between the output and GND is compared to the internal +1.0V reference to set the regulation voltage.
8	NC	Not connected.

TYPICAL PERFORMANCE CHARACTERISTICS

$V_{IN}=12V$, $V_{OUT}=3.3V$, $L=3.3\mu H$, $C_{OUT}=22\mu F$, unless otherwise noted.

Efficiency vs. Load Current

$V_{OUT}=3.3V$

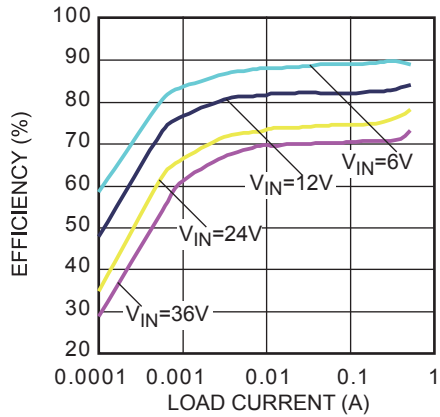

Quiescent Current vs. Input Voltage

$EN=2V$, $V_{FB}=1.1V$

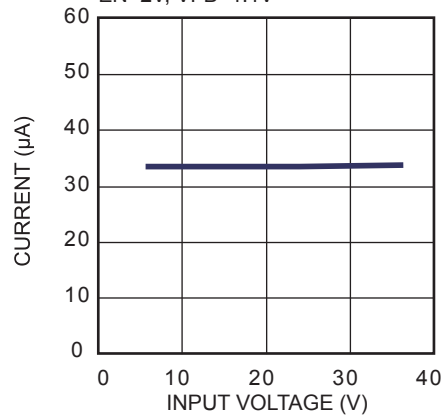

Shutdown Current vs. Input Voltage

$EN=0V$

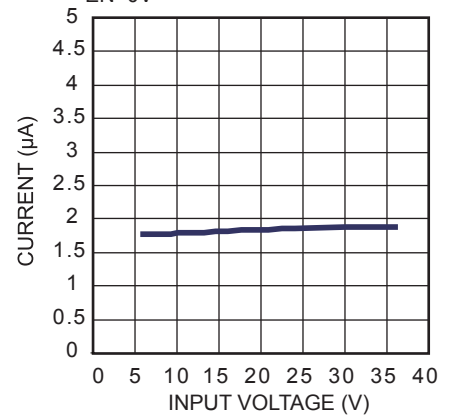

Load Regulation @ $V_{OUT}=3.3V$

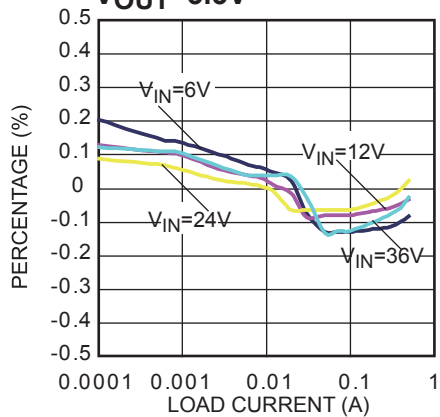

Line Regulation

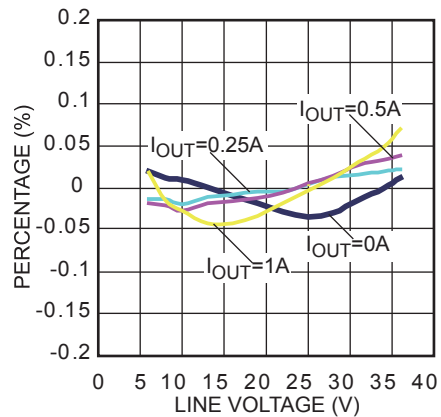

Case Temp. vs. Load Current

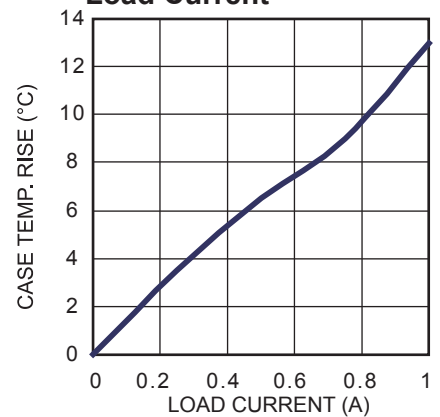

TYPICAL PERFORMANCE CHARACTERISTICS (continued)

$V_{IN}=12V$, $V_{OUT}=3.3V$, $L=3.3\mu H$, $C_{OUT}=22\mu F$, unless otherwise noted.

Output Ripple Voltage
 $I_{OUT} = 0A$

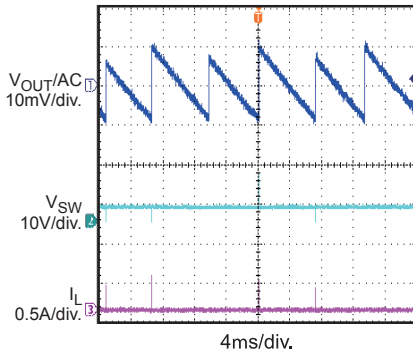

Output Ripple Voltage
 $I_{OUT} = 0.5A$

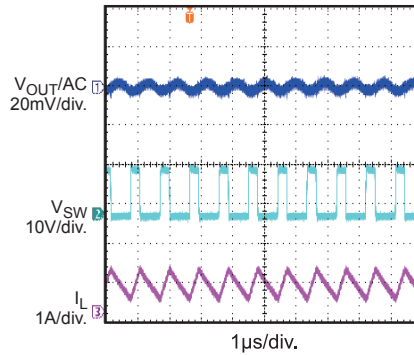

VIN Power Up without Load

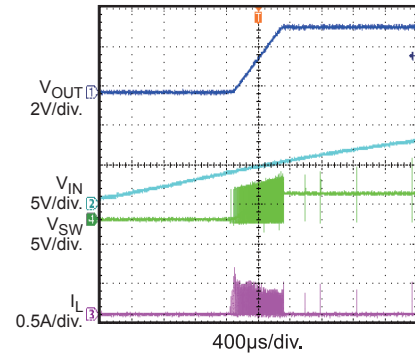

VIN Shut Down without Load

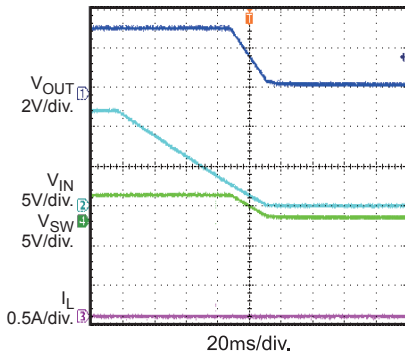

VIN Power Up with 0.5A Resistor Load

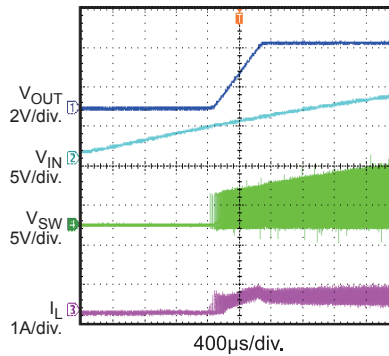

VIN Shut Down with 0.5A Resistor Load

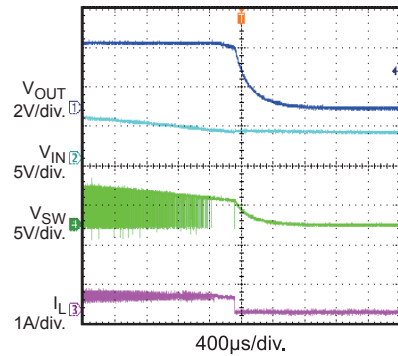

EN Start Up without Load

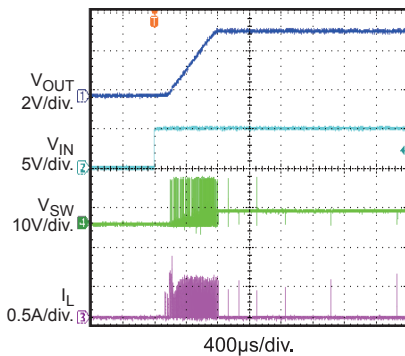

EN Shut Down without Load

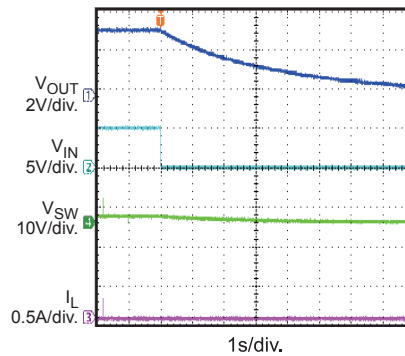

EN Start Up with 0.5A Resistor Load

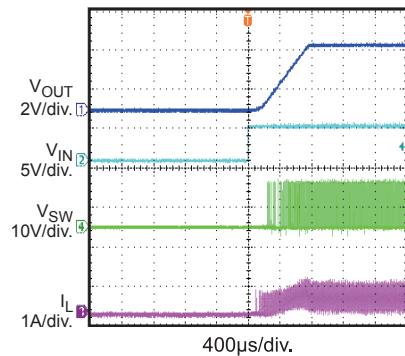

TYPICAL PERFORMANCE CHARACTERISTICS *(continued)*

$V_{IN}=12V$, $V_{OUT}=3.3V$, $L=3.3\mu H$, $C_{OUT}=22\mu F$, unless otherwise noted.

EN Shut Down with 0.5A Resistor Load

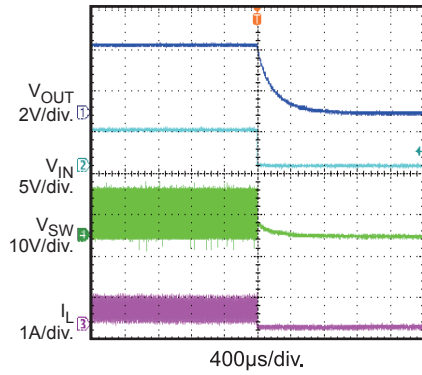

Load Transient Response
 $I_{OUT} = 0.3A-0.6A$, $C_{FF}=39pF$

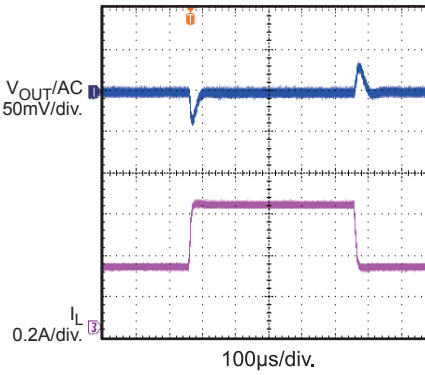

Load Transient Response
 $I_{OUT} = 0.3A-0.6A$, $C_{FF}=150pF$

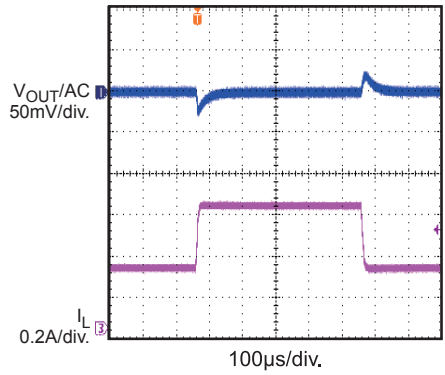

Short Entry

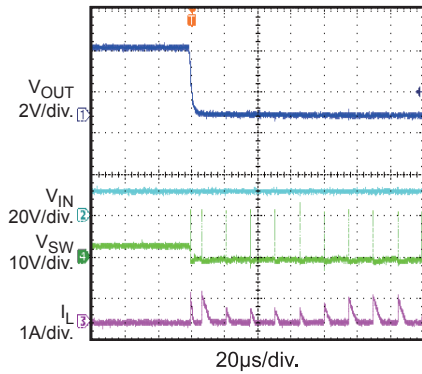

Short Circuit

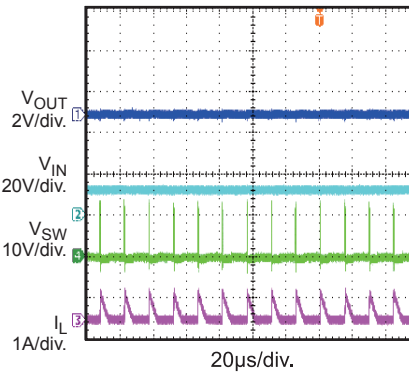

Short Recovery

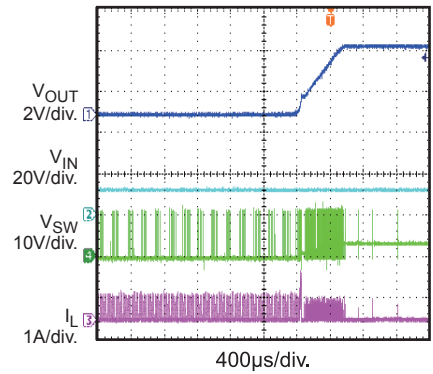

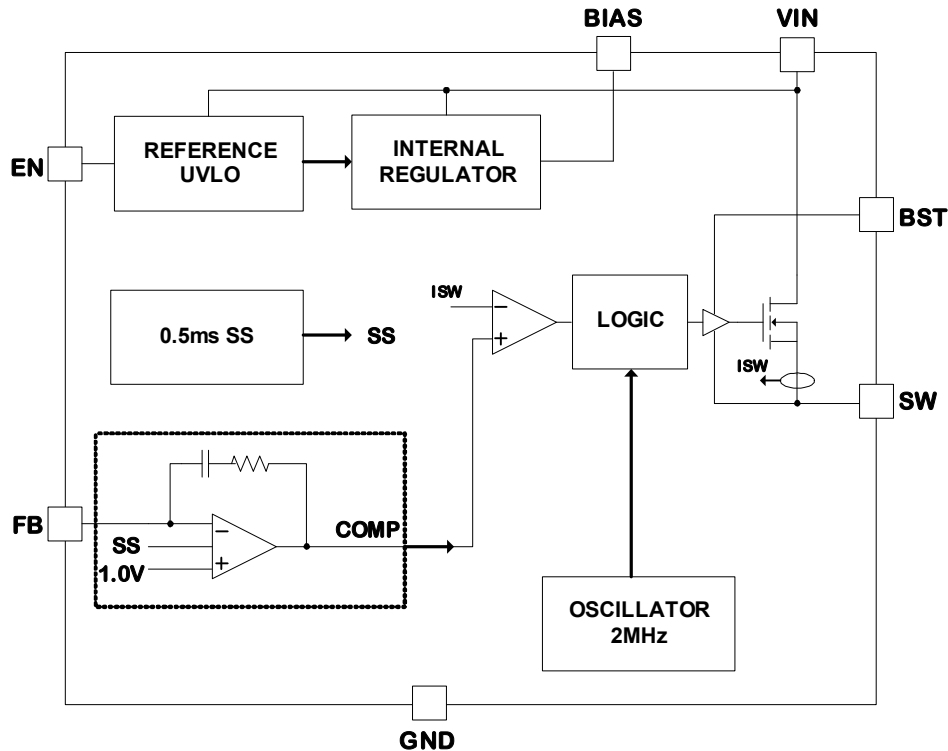
Figure 1—Functional Block Diagram

OPERATION

The MP4566 is a 1MHz, non-synchronous, step-down switching regulator with integrated internal high-side high voltage power MOSFET. It provides internally compensated single 0.6A highly efficient output with current mode control. It features wide input voltage range, internal soft-start control, and precision current limit. Its very low operational quiescent current suits it for battery powered applications.

PWM Control

At moderate to high output current, the MP4566 operates in a fixed frequency, peak current control mode to regulate the output voltage. A PWM cycle is initiated by the internal clock. The power MOSFET is turned on and remains on until its current reaches the value set by COMP voltage. When the power switch is off, it remains off for at least 100ns before the next cycle starts. If, in one PWM period, the current in the power MOSFET does not reach COMP set current value, the power MOSFET remains on, saving a turn-off operation.

Pulse Skipping Mode

At light load condition, the MP4566 goes into pulse skipping mode to improve light load efficiency. Pulse skipping decision is based on its internal COMP voltage. If COMP is lower than the internal sleep threshold, a PAUSE command is generated to block the turn-on clock pulse so the power MOSFET is not commanded ON subsequently, saving gate driving and switching losses. This PAUSE command also puts the whole chip into sleep mode, consuming very low quiescent current to further improve the light load efficiency.

When COMP voltage is higher than the sleep threshold, the PAUSE signal is reset so the chip is back into normal PWM operation. Every time when the PAUSE changes states from low to high, a turn-on signal is generated right away, turning on the power MOSFET.

Error Amplifier

The Error amplifier is composed of an internal OP-AMP with an R-C feedback network connected between its output node (internal COMP node) and its negative input node (FB). When FB is lower than its internal reference voltage (REF), the COMP output is then driven higher by the OP-AMP, causing higher switch peak current output hence more energy delivered to the output. Vice versus.

When connecting to the FB pin, normally there is a voltage divider composed of R_{UP} and R_{DN} where R_{DN} is between FB and GND while R_{UP} is between the voltage output node and FB. R_{UP} serves also to control the gain of the error amplifier along with the internal compensation R-C network.

Internal Regulator

Most of the internal circuitries are powered on by the 2.6V internal regulator. This regulator takes V_{IN} input and operates in the full V_{IN} range. When V_{IN} is greater than 3.0V, the output of the regulator is in full regulation. When V_{IN} is lower, the output degrades.

Enable Control

The MP4566 has a dedicated enable control pin EN. With high enough V_{IN} , the chip can be enabled and disabled by EN pin. This is a HIGH effective logic. Its trailing threshold is a consistent 1.2V. Its rising threshold is about 400mV higher. When floating, EN pin is internally pulled up high so the chip is automatically on.

When EN is pulled down to 0V, the chip is put into the lowest shutdown current mode. When EN is higher than zero but lower than its rising threshold, the chip is still in shutdown mode but the shutdown current increases slightly.

Under Voltage Lockout (UVLO)

V_{IN} Under voltage lockout (UVLO) is implemented to protect the chip from operating at insufficient supply voltage. The UVLO rising threshold is about 4.0V while its trailing threshold is a consistent 3.6V.

Internal Soft-start

Reference type soft-start is implemented to prevent the converter output voltage from overshooting during startup. When the chip starts, the internal circuitry generates a soft-start voltage (SS) ramping up from 0V at a slow pace set by the soft-start time. When it is lower than the internal reference REF, SS overrides the REF so the error amplifier uses SS instead of REF as the reference. When SS is higher than REF, REF gains the control back.

SS is also associated with FB. Though SS can be much lower than FB, it can only be slightly higher than FB. If somehow FB is brought down, SS follows to track FB. This function is designed to accommodate the short-circuit recovery situation. When the short circuit is removed, the SS ramps up as if it is a fresh soft-start process. This prevents output voltage overshoot.

Thermal Shutdown

Thermal shutdown is implemented to prevent the chip from thermally running away. When the silicon die temperature is higher than its upper threshold, it shuts down the whole chip. When the temperature is lower than its lower threshold, thermal shutdown is gone so the chip is enabled again.

Floating Driver and Bootstrap Charging

The floating power MOSFET driver is powered by an external bootstrap capacitor. This floating driver has its own UVLO protection. This UVLO's rising threshold is about 2.4V with a threshold of about 300mV. During this UVLO, the SS voltage of the controller is reset to zero. When the UVLO is removed, the controller follows soft-start process.

The bootstrap capacitor is charged and regulated to about 5V by the dedicated internal bootstrap regulator. When the voltage between BST and SW nodes is lower than its regulation, a PMOS pass transistor connected from V_{IN} to BST is turned on. The charging current path is from V_{IN} , BST and then to SW. External circuit should provide enough voltage headroom to facilitate the charging.

As long as VIN is sufficiently higher than SW, the bootstrap capacitor can be charged. When the power MOSFET is ON, VIN is about equal to SW so the bootstrap capacitor cannot be charged. When the external free wheeling diode is on, VIN to SW difference is the largest so it is the best period to charge. When there is no current in the inductor, SW equals to the output voltage VOUT so the difference between VIN and VOUT can be used to charge the bootstrap capacitor.

At higher duty cycle operation condition, the time period available to the bootstrap charging is less so the bootstrap capacitor may not be charged sufficiently.

In case the external circuit has not sufficient voltage and time to charge the bootstrap capacitor, extra external circuitry can be used to ensure the bootstrap voltage in normal operation region.

The floating driver's UVLO is not communicated to the controller.

The DC quiescent current of the floating driver is about 20 μ A. Make sure the bleeding current at SW node is at least higher than this number.

Current Comparator and Current Limit

The power MOSFET current is accurately sensed via a current sense MOSFET. It is then fed to the high speed current comparator for the current mode control purpose. The current comparator takes this sensed current as one of its inputs. When the power MOSFET is turned on, the comparator is first blanked till the end of the turn-on transition to dodge the noise. Then, the comparator compares the power switch current with COMP voltage. When the sensed current is higher than COMP voltage, the comparator outputs is low, turning off the power MOSFET. The maximum current of the internal power MOSFET is internally limited cycle by cycle.

Startup and Shutdown

If both VIN and EN are higher than their appropriate thresholds, the chip starts. The reference block starts first, generating stable reference voltage and currents and then the internal regulator is enabled. The regulator provides stable supply for the rest circuitries.

While the internal supply rail is up, an internal timer holds the power MOSFET OFF for about 50 μ sec to blank the startup glitches. When the internal soft-start block is enabled, it first holds its SS output low to ensure the rest circuitries are ready and then slowly ramps up.

Three events shut down the chip: EN low, VIN low, thermal shutdown. In the shutdown procedure, the signaling path is blocked first to avoid any fault triggering. COMP voltage and the internal supply rail are pulled down then. The floating driver is not subject to this shutdown command but its charging path is disabled.

APPLICATION INFORMATION

Setting the Output Voltage

The external resistor divider from output voltage to FB pin is used to set the output voltage. The feedback resistor R1 also sets the feedback loop bandwidth with the internal compensation capacitor. Choose R1 to be around 150~200kΩ. R2 is then given by:

$$R2 = \frac{R1}{\frac{V_{out}}{1.0} - 1}$$

Table 1 lists the recommended T-type resistors value for common output voltages.

Table 1—Resistor Selection for Common Output Voltages

V _{OUT} (V)	R1 (kΩ)	R2 (kΩ)
1.8	150(1%)	187(1%)
2.5	150(1%)	100(1%)
3.3	187(1%)	80.6(1%)

Selecting the Inductor

The inductor is required to supply constant current to the output load while being driven by the switched input voltage. A larger value inductor will result in less ripple current that will result in lower output ripple voltage with the same output capacitors. However, the larger value inductor will have a larger physical size, higher series resistance, and/or lower saturation current as well as the slow load transient dynamic. A good rule for determining the inductance to use is to allow the peak-to-peak ripple current in the inductor to be approximately 30% of the maximum switch current limit. The inductance value can be calculated by:

$$L_1 = \frac{V_{OUT} \times (V_{IN} - V_{OUT})}{V_{IN} \times \Delta I_L \times f_{OSC}}$$

Where V_{IN} is the input voltage, f_{osc} is the switching frequency and ΔI_L is the inductor ripple current.

Choose an inductor that will not saturate under the maximum inductor peak current. The peak inductor current can be calculated by:

$$I_{L(MAX)} = I_{LOAD} + \frac{\Delta I_L}{2}$$

where I_{LOAD} is the load current.

Selecting the Output Rectifier Diode

The output rectifier diode supplies the current to the inductor when the high-side switch is off. To reduce losses due to the diode forward voltage and recovery times, use a Schottky diode. Choose a diode whose maximum reverse voltage rating is greater than the maximum input voltage, and whose current rating is greater than the maximum load current. Table 2 lists example Schottky diodes and manufacturers.

Table 2—Output Schottky Diodes

Manufacturer	Part Number	Voltage Rating (V)	Current Rating (A)	Package
Diodes Inc.	B240-13-F	40V	2A	SMA
Diodes Inc.	B340-13-F	40V	3A	SMA
Central semi	CMSH2-40M	40V	2A	SMA
Central semi	CMSH3-40MA	40V	3A	SMA

Selecting the Input Capacitor

The input current to the step-down converter is discontinuous, therefore a capacitor is required to supply the AC current to the step-down converter while maintaining the DC input voltage. Use low ESR capacitors for the best performance. Ceramic capacitors with X5R or X7R dielectrics are highly recommended because of their low ESR and small temperature coefficients. For most applications, a 10µF capacitor is sufficient. For higher output voltage, 22µF may be needed for more stable system.

Since the input capacitor absorbs the input switching current it requires an adequate ripple current rating. The RMS current in the input capacitor can be estimated by:

$$I_{C1} = I_{LOAD} \times \sqrt{\frac{V_{OUT}}{V_{IN}} \times \left(1 - \frac{V_{OUT}}{V_{IN}}\right)}$$

The worse case condition occurs at V_{IN} = 2V_{OUT}, where:

$$I_{C1} = \frac{I_{LOAD}}{2}$$

For simplification, choose the input capacitor whose RMS current rating greater than half of the maximum load current. The input capacitor can be electrolytic, tantalum or ceramic. When using electrolytic or tantalum capacitors, a small, high quality ceramic capacitor, i.e. 0.1µF, should be placed as close to the IC as possible. When using ceramic capacitors, make sure that they have enough capacitance to provide sufficient charge to prevent excessive voltage ripple at input. The input voltage ripple caused by capacitance can be estimated by:

$$\Delta V_{IN} = \frac{I_{LOAD}}{f_s \times C1} \times \frac{V_{OUT}}{V_{IN}} \times \left(1 - \frac{V_{OUT}}{V_{IN}}\right)$$

Where C1 is the input capacitance value.

Selecting the Output Capacitor

The output capacitor is required to maintain the DC output voltage. Ceramic, tantalum, or low ESR electrolytic capacitors are recommended. Low ESR capacitors are preferred to keep the output voltage ripple low. The output voltage ripple can be estimated by:

$$\Delta V_{OUT} = \frac{V_{OUT}}{f_s \times L_1} \times \left(1 - \frac{V_{OUT}}{V_{IN}}\right) \times \left(R_{ESR} + \frac{1}{8 \times f_s \times C2}\right)$$

Where L₁ is the inductor value, C2 is the output capacitance value and R_{ESR} is the equivalent series resistance (ESR) value of the output capacitor.

In the case of ceramic capacitors, the impedance at the switching frequency is dominated by the capacitance. The output voltage ripple is mainly caused by the capacitance. For simplification, the output voltage ripple can be estimated by:

$$\Delta V_{OUT} = \frac{V_{OUT}}{8 \times f_s^2 \times L_1 \times C2} \times \left(1 - \frac{V_{OUT}}{V_{IN}}\right)$$

In the case of tantalum or electrolytic capacitors, the ESR dominates the impedance at the switching frequency. For simplification, the output ripple can be approximated to:

$$\Delta V_{OUT} = \frac{V_{OUT}}{f_s \times L_1} \times \left(1 - \frac{V_{OUT}}{V_{IN}}\right) \times R_{ESR}$$

The characteristics of the output capacitor also affect the stability of the regulation system. The

MP4566 can be optimized for a wide range of capacitance and ESR values.

Compensation Components

MP4566 employs current mode control for easy compensation and fast transient response. It already integrates the compensation components inside. Thus, just choosing appropriate feedback resistor divider is enough for obtaining a stable and fast transient performance. Generally, choosing R1 to be around 150k to 200k is recommended. In order to adjust load transient dynamic performance, slightly changing the feed-forward capacitor from 15pF to 150pF range is recommended.

External Bootstrap Diode

An external bootstrap diode may enhance the efficiency of the regulator, the applicable conditions of external BST diode are:

- V_{OUT} is 5V or 3.3V; and
- Duty cycle is high: $D = \frac{V_{OUT}}{V_{IN}} > 65\%$

In these cases, an external BST diode is recommended from the VCC pin to BST pin, as shown in Figure 2.

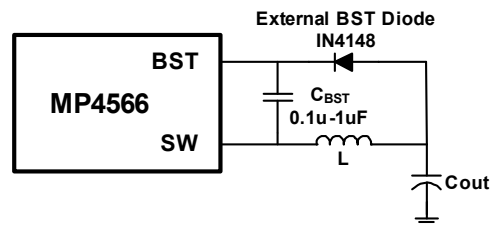

Figure 2—Add Optional External Bootstrap Diode to Enhance Efficiency

The recommended external BST diode is IN4148, and the BST cap is 0.1~1µF.

PC Board Layout

PCB layout is very important to achieve stable operation. It is highly recommended to duplicate EVB layout for optimum performance.

If change is necessary, please follow these guidelines.

- 1) Keep the path of switching current short and minimize the loop area formed by Input capacitor, high-side MOSFET and external switching diode.
- 2) Bypass ceramic capacitors are suggested to be put close to the VIN pin.
- 3) Ensure all feedback connections are short and direct. Place the feedback resistors as close to the chip as possible.
- 4) Route SW away from sensitive analog areas such as FB.
- 5) Connect IN, SW and especially GND respectively to a large copper area to cool the chip to improve thermal performance and long-term reliability.

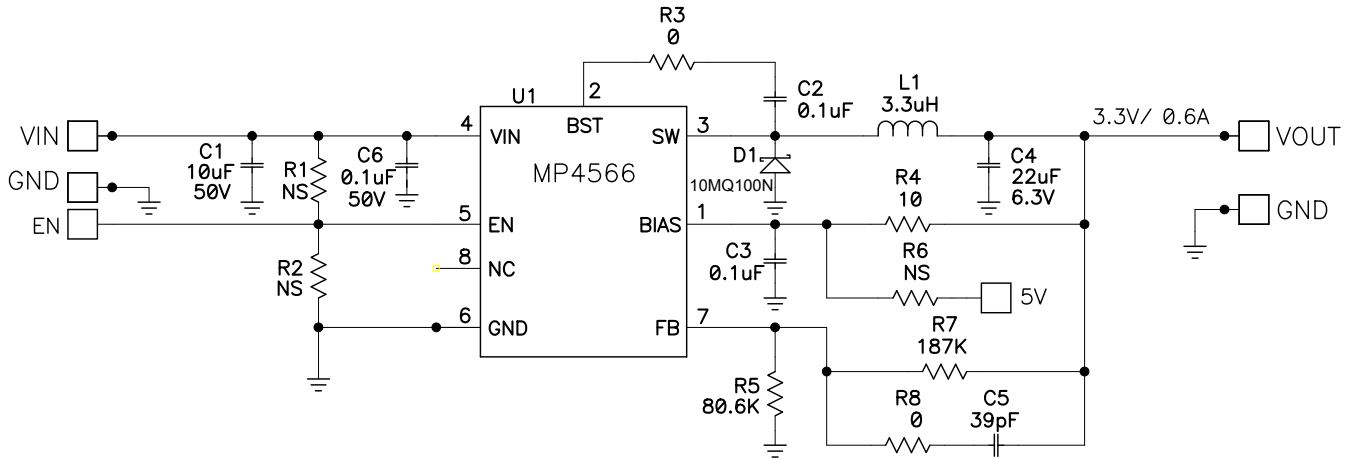
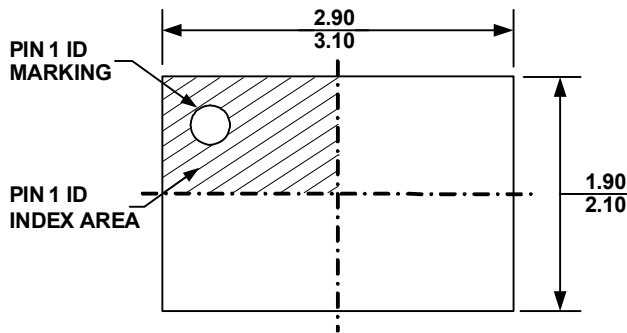

Figure 3—MP4566 Typical Application Circuit

PACKAGE INFORMATION

QFN8 (2mm x 3mm)



TOP VIEW

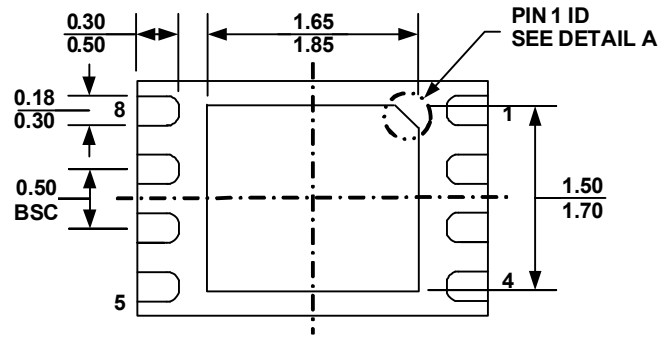

BOTTOM VIEW

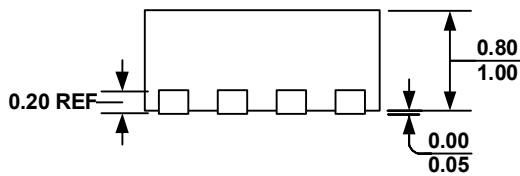

SIDE VIEW

PIN 1 ID OPTION A
0.30x45° TYP.



PIN 1 ID OPTION B
R0.20 TYP.



DETAIL A

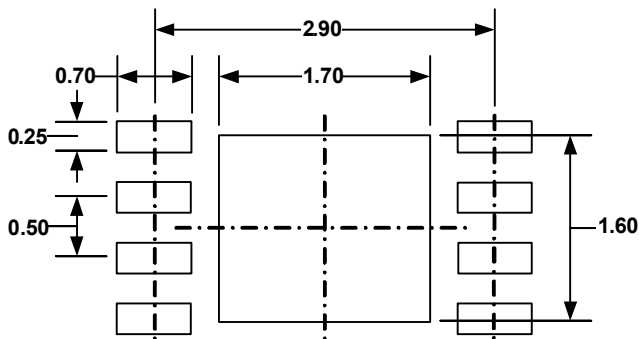

RECOMMENDED LAND PATTERN

NOTE:

- 1) ALL DIMENSIONS ARE IN MILLIMETERS
- 2) EXPOSED PADDLE SIZE DOES NOT INCLUDE MOLD FLASH
- 3) LEAD COPLANARITY SHALL BE 0.10 MILLIMETER MAX
- 4) DRAWING CONFORMS TO JEDEC MO229, VARIATION VCED-2.
- 5) DRAWING IS NOT TO SCALE

NOTICE: The information in this document is subject to change without notice. Users should warrant and guarantee that third party Intellectual Property rights are not infringed upon when integrating MPS products into any application. MPS will not assume any legal responsibility for any said applications.