

DESCRIPTION

The MP6514 is an H-bridge motor driver that consists of four N-channel power MOSFETs. An internal charge pump generates the necessary gate drive voltages.

The MP6514 can drive two DC motors in a single-ended connection with separate controls for the high-side or low-side MOSFETs. The motor can be connected to either the supply or GND.

The MP6514 operates on a motor power supply voltage from 2.5V to 14V, which can supply an output current of up to 0.6A according to the operation.

Full protection features include over-current protection (OCP), short-circuit protection (SCP), under-voltage lockout (UVLO), and over-temperature protection (OTP).

The MP6514 requires a minimum number of readily available, standard, external components and is available in a UTQFN-8 (2mmx2mm) package.

FEATURES

- Wide 2.5V to 14V Operating Input Range
- Peak Current: 0.6A
- Low MOSFET On Resistance (HS: 500mΩ, LS: 500mΩ)
- Crossover Current Protection
- Low Standby Circuit Current when All Inputs Are Low
- Thermal Shutdown
- Internal Charge Pump
- Cycle-by-Cycle Over-Current Protection (OCP)
- Short-Circuit Protection (SCP)
- Available in a UTQFN-8 (2mmx2mm) Package

APPLICATIONS

- Toys
- Consumer Products
- Medical Devices

All MPS parts are lead-free, halogen-free, and adhere to the RoHS directive. For MPS green status, please visit the MPS website under Quality Assurance. "MPS" and "The Future of Analog IC Technology" are registered trademarks of Monolithic Power Systems, Inc.

TYPICAL APPLICATION

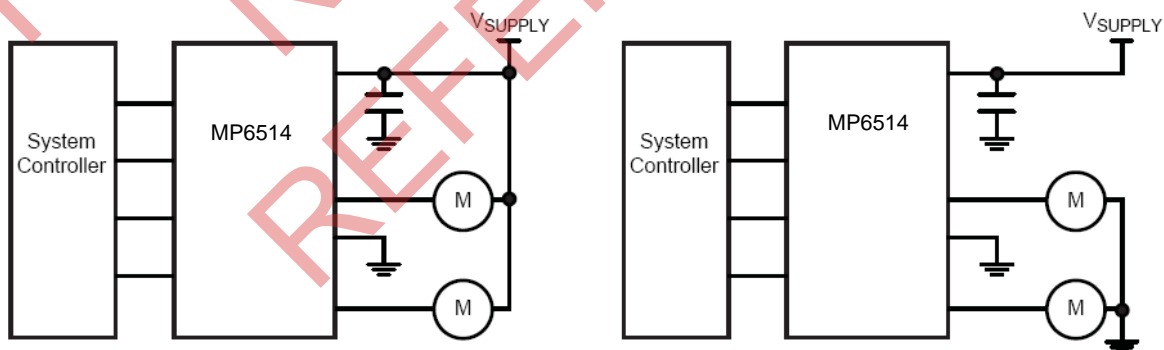

(A) Connection to Supply

(B) Connection to Ground

ORDERING INFORMATION

Part Number*	Package	Top Marking
MP6514GGU	UTQFN-8 (2mmx2mm)	See Below

* For Tape & Reel, add suffix -Z (e.g. MP6514GGU-Z)

TOP MARKING

—
CVY
LLL

CV: Product code of MP6514GGU
Y: Year code
LLL: Lot number

PACKAGE REFERENCE

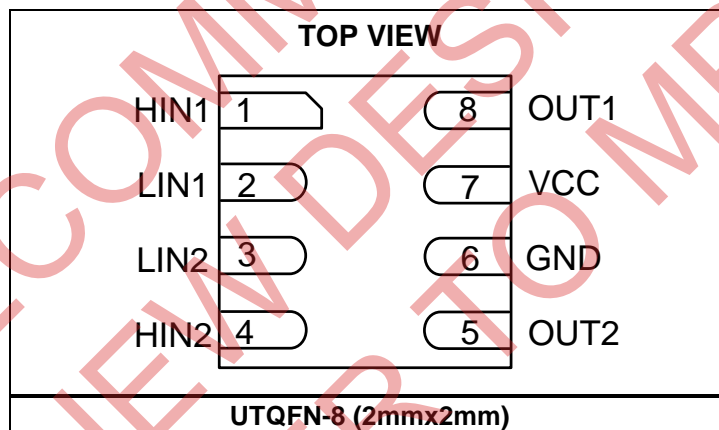

ABSOLUTE MAXIMUM RATINGS ⁽¹⁾

Supply voltage (V_{CC})	-0.3V to +18V
V_{OUTX}	-0.3V to $V_{CC} + 0.3V$
All other pins	-0.3V to +6V
Continuous power dissipation ($T_A = +25^\circ C$) ⁽²⁾	
UTQFN-8 (2mmx2mm)	1.39W
Junction temperature	150°C
Lead temperature	260°C
Storage temperature	-60°C to 150°C

Recommended Operating Conditions ⁽³⁾

Supply voltage (V_{CC})	2.5V to 14V
Operating junction temp. (T_J)	-40°C to +125°C

Thermal Resistance ⁽⁴⁾	θ_{JA}	θ_{JC}
UTQFN-8 (2mmx2mm)	90	20 ... °C/W

NOTES:

- Exceeding these ratings may damage the device.
- The maximum allowable power dissipation is a function of the maximum junction temperature T_J (MAX), the junction-to-ambient thermal resistance θ_{JA} , and the ambient temperature T_A . The maximum allowable continuous power dissipation at any ambient temperature is calculated by P_D (MAX) = $(T_J$ (MAX) - T_A) / θ_{JA} . Exceeding the maximum allowable power dissipation produces an excessive die temperature, causing the regulator to go into thermal shutdown. Internal thermal shutdown circuitry protects the device from permanent damage.
- The device is not guaranteed to function outside of its operating conditions.
- Measured on JESD51-7, 4-layer PCB.

ELECTRICAL CHARACTERISTICS

$V_{CC} = 5V$, $T_J = -40^{\circ}C$ to $+125^{\circ}C$, unless otherwise noted.

Parameters	Symbol	Condition	Min	Typ	Max	Units
Operating supply current		No PWM		0.75	1.2	mA
Sleep mode supply current	I_Q	HIN1 = HIN2 = LIN1 = LIN2 = 0V		12	20	μA
Under-voltage lockout threshold rising				2.2	2.45	V
Under-voltage lockout threshold hysteresis				150		mV
Input high voltage	V_{IH}		2			V
Input low voltage	V_{IL}				0.4	V
Input high current	I_{IH}	$V_{IN} = 3.3V$			50	μA
Input low current	I_{IL}	$V_{IN} = 0V$	-5		5	μA
Input pull-down resistance	R_{PD}			100		k Ω
HS switch-on resistance	$R_{DS(ON)}$	$I_O = 100mA$ $T_A = 25^{\circ}C$		0.5	0.6	Ω
LS switch-on resistance	$R_{DS(ON)}$	$I_O = 100mA$ $T_A = 25^{\circ}C$		0.5	0.6	Ω
Current limit	I_{OCP}		1		2	A
OCP retry time	T_{OCR}			0.85		ms
Sleep entry time		HIN1 = HIN2 = LIN1 = LIN2 = 0V for 2mS		2	5	ms
Sleep recovery time		One input = high level			6.5	μs
Output enable time	T1, T3				270	ns
Output disable time	T2, T4				270	ns
Output rise time					50	ns
Output fall time					50	ns
Dead time				100		ns
Thermal shutdown threshold ⁽⁵⁾	T_J Rising			160		$^{\circ}C$
Thermal shutdown hysteresis				25		$^{\circ}C$

NOTE:

5) Guaranteed by design.

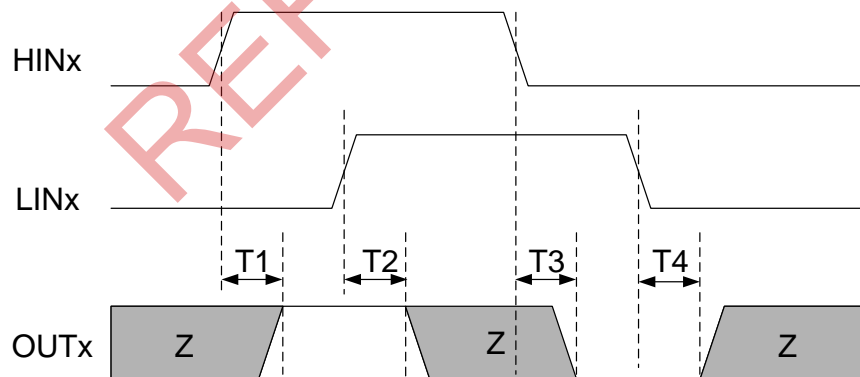
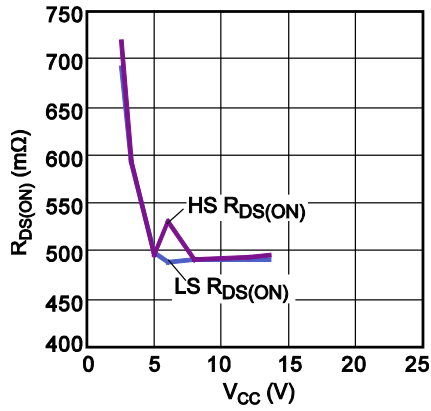

Figure 1: Input/Output Timing Diagram

TYPICAL PERFORMANCE CHARACTERISTICS

$V_{CC} = 5V$, $T_A = 25^\circ C$, unless otherwise noted.

$R_{DS(ON)}$ vs. V_{CC}



$R_{DS(ON)}$ vs. Temperature

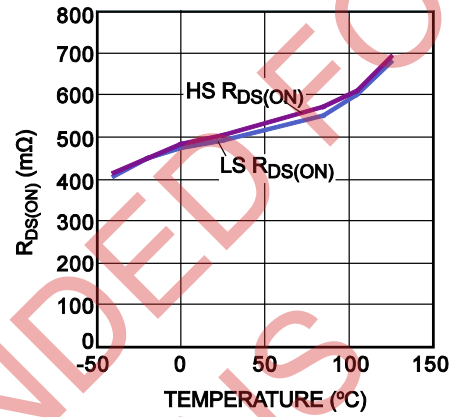

TYPICAL PERFORMANCE CHARACTERISTICS *(continued)*

$V_{CC} = 5V$, $T_A = 25^\circ C$, unless otherwise noted.

Power Start-Up

$V_{DD} = 5V$, PWM = 100Hz,
No Load

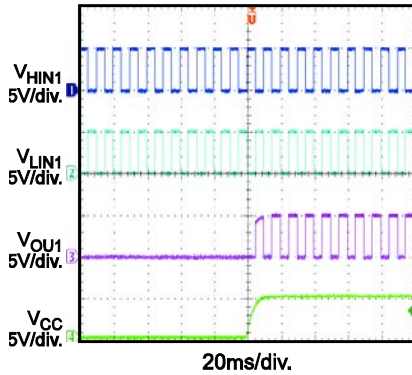

Power Down

$V_{DD} = 5V$, PWM = 100Hz,
No Load

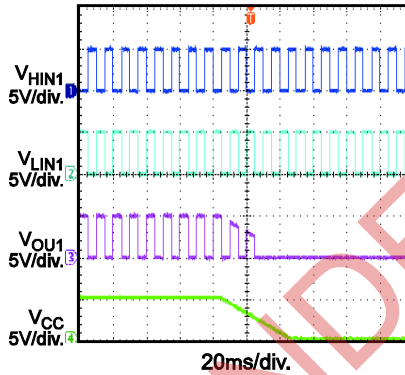

Output Enable Time (T1)

$V_{DD} = 5V$, No Load

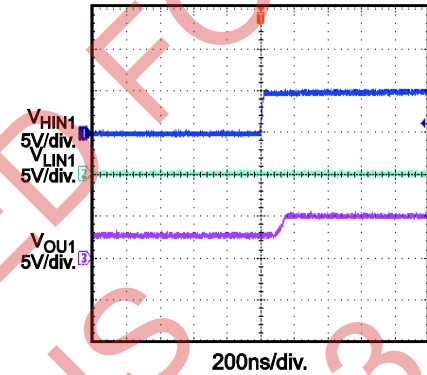

Output Disable Time (T2)

$V_{DD} = 5V$, No Load

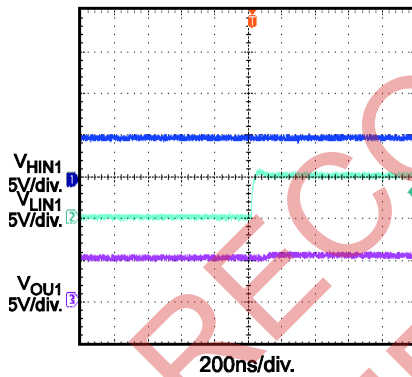

Output Enable Time (T3)

$V_{DD} = 5V$, No Load

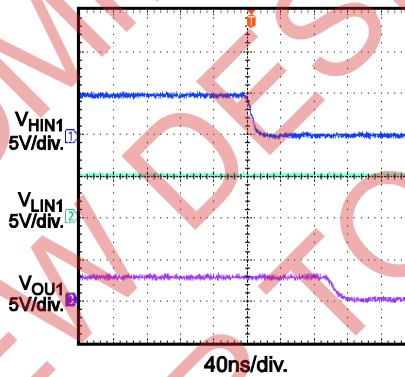

Output Disable Time (T4)

$V_{DD} = 5V$, No Load

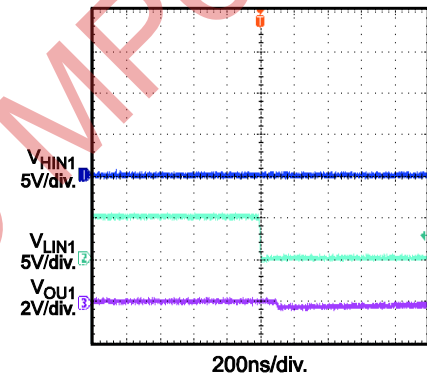

Sleep Mode Entry

$V_{DD} = 5V$, No Load,
 $HIN2 = LIN2 = 0$

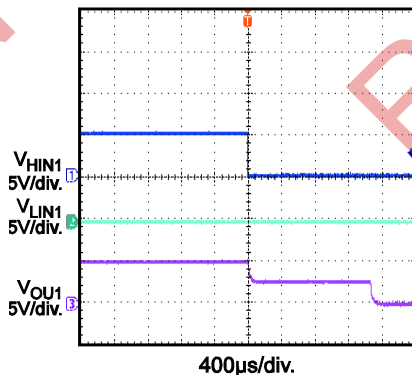

Sleep Mode Recovery

$V_{DD} = 5V$, No Load,
 $HIN2 = LIN2 = 0$

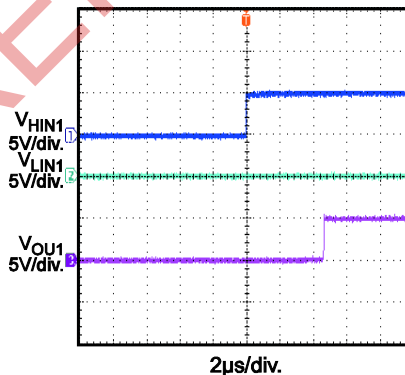

PIN FUNCTIONS

Pin #	Name	Description
1	HIN1	Logic input. HIN1 has an internal pull-down resistor.
2	LIN1	Logic input. LIN1 has an internal pull-down resistor.
3	HIN2	Logic input. HIN2 has an internal pull-down resistor.
4	LIN2	Logic input. LIN2 has an internal pull-down resistor.
5	OUT2	Switch output 2. Connect OUT2 to the motor winding.
6	GND	Ground.
7	VCC	Supply voltage. An input capacitor is needed at VCC to prevent large voltage spikes from appearing at the input.
8	OUT1	Switch output 1. Connect OUT1 to the motor winding.

NOT RECOMMENDED FOR
NEW DESIGNS
REFER TO MP6513

BLOCK DIAGRAM

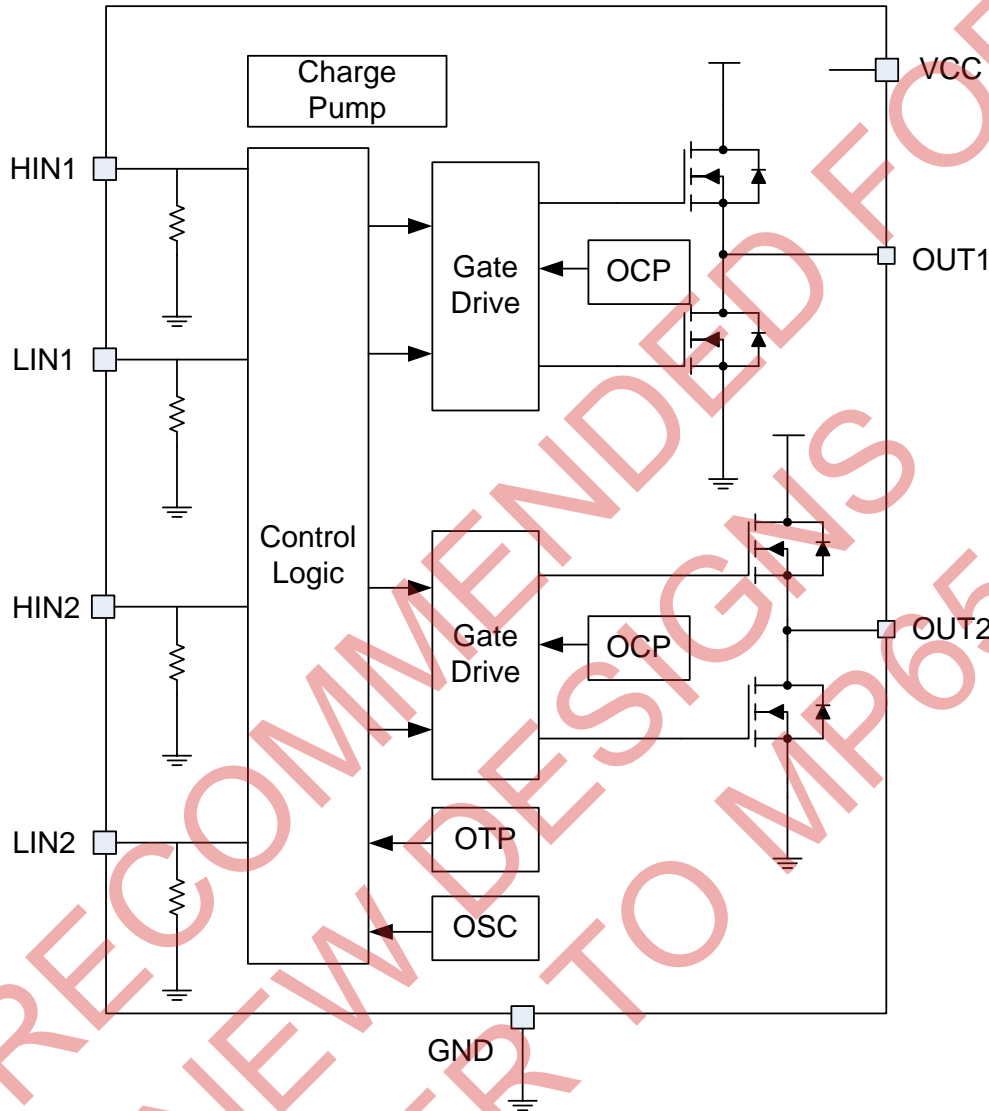

Figure 2: Functional Block Diagram

OPERATION

The MP6514 is an H-bridge motor driver that consists of four N-channel power MOSFETs. An internal charge pump generates the necessary gate drive voltages.

Input Logic

The MP6514 can drive two DC motors in a single-ended connection with separate controls for the high-side or low-side MOSFETs. The motor can be connected to either the supply or GND.

Table 1 shows the logic for the MP6514.

Table 1: Input Logic Truth Table

HINx	LINx	OUTx	Function Motor to Supply	Function Motor to GND
L	L	Z	Coast (sleep)	Coast (sleep)
L	H	L	Drive	Brake
H	L	H	Brake	Drive
H	H	Z	Coast	Coast

Sleep Mode

If all input pins (HIN1, HIN2, LIN1, and LIN2) remain at a low level within a certain time, then the MP6514 enters a low-power sleep mode. In this state, all unnecessary internal circuitry is powered down.

Protection Circuits

The MP6514 is fully protected against under-voltage, over-current, and over-temperature events.

Over-Current Protection (OCP)

The MP6514 has internal overload and short-circuit protection. The currents in both the high-side and low-side MOSFETs are measured, and if the current exceeds the current limit, then all MOSFETs in the H-bridge are turned off. After approximately 1ms, the bridge is re-enabled automatically.

Thermal Shutdown (TSD)

Thermal monitoring is integrated into the MP6514. If the die temperature rises above 160°C, all switches turn off. Once the die temperature falls back to a safe level, operation resumes automatically.

Under-Voltage Lockout (UVLO)

If the voltage on VCC falls below the under-voltage lockout threshold voltage at any time, all circuitry in the device is disabled, and the internal logic is reset. Operation resumes when VCC rises above the UVLO threshold.

PACKAGE INFORMATION

UTQFN-8 (2mmx2mm)

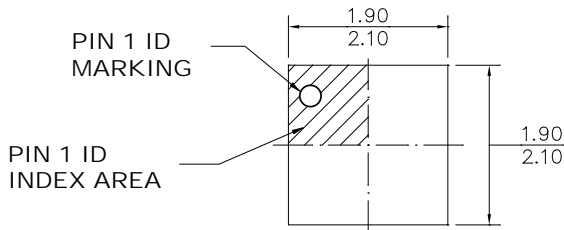

TOP VIEW

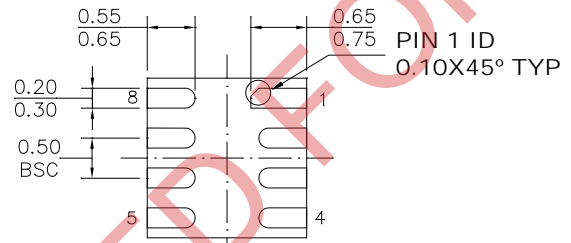

BOTTOM VIEW

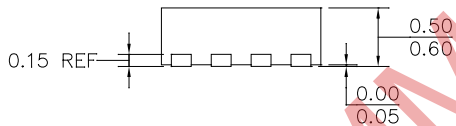

SIDE VIEW

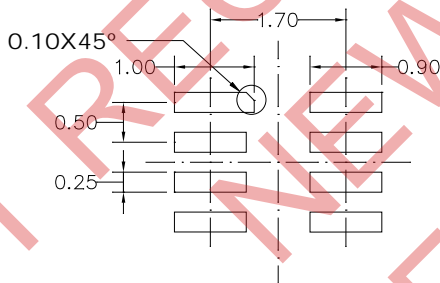

RECOMMENDED LAND PATTERN

NOTE:

- 1) ALL DIMENSIONS ARE IN MILLIMETERS.
- 2) EXPOSED PADDLE SIZE DOES NOT INCLUDE MOLD FLASH.
- 3) LEAD COPLANARITY SHALL BE 0.10 MILLIMETERS MAX.
- 4) JEDEC REFERENCE IS MO-229.
- 5) DRAWING IS NOT TO SCALE.

NOTICE: The information in this document is subject to change without notice. Users should warrant and guarantee that third party Intellectual Property rights are not infringed upon when integrating MPS products into any application. MPS will not assume any legal responsibility for any said applications.