

DESCRIPTION

The MP6550 is an H-bridge motor driver. The H-bridge consists of four N-channel power MOSFETs and an internal charge pump to generate gate-drive voltages. The MP6550 is typically used to drive a DC brush motor.

The MP6550 operates on a motor power supply voltage from 1.8V to 22V, which can supply an output current of up to 2A according to the logic control.

The MP6550 has a PWM input interface, which is compatible with industry-standard devices. Very low standby circuit current can be achieved when the device is disabled.

An internal current-sensing circuit provides an output with a voltage proportional to the load current. Cycle-by-cycle current regulation and limiting is also provided. These features do not require the use of a low-value shunt resistor.

There are internal shutdown functions for over-current protection, short-circuit protection, under-voltage lockout, and over-temperature protection.

The MP6550 requires a minimal number of readily available, standard external components, and is available in a QFN-12 (2mmx2mm) package.

FEATURES

- Wide 1.8V to 22V Operating Input Range
- 2A Continuous Driver Current
- MOSFET On Resistance (HS + LS) 240mΩ
- Cycle-by-Cycle Current Regulation/Limit
- Built-In 3.3V Reference Output
- PWM Input Interface, Compatible with Industry-Standard Devices, Up to 100kHz
- Low Standby Circuit Current
- Thermal Shutdown
- Internal Charge Pump
- Cycle-by-Cycle Over-Current Protection
- Short-Circuit Protection
- Available in a QFN-12 (2mmx2mm) Package

APPLICATIONS

- Robotics
- Cameras
- Toys
- Consumer Products
- Medical Devices

All MPS parts are lead-free, halogen free, and adhere to the RoHS directive. For MPS green status, visit the MPS website under Quality Assurance. "MPS", the MPS logo, and "Simple, Easy Solutions" are registered trademarks of Monolithic Power Systems, Inc. or its subsidiaries.

TYPICAL APPLICATION

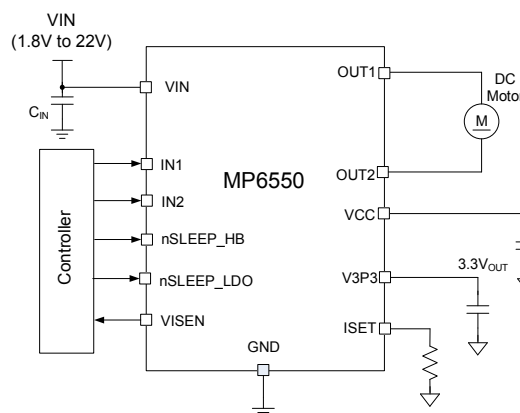

ORDERING INFORMATION

Part Number*	Package	Top Marking
MP6550GG	QFN-12 (2mmx2mm)	See Below

* For Tape & Reel, add suffix -Z (e.g. MP6550GG-Z).

TOP MARKING

—
GXY
LLL

GX: Product code of MP6550GG
 Y: Year code
 LLL: Lot number

PACKAGE REFERENCE

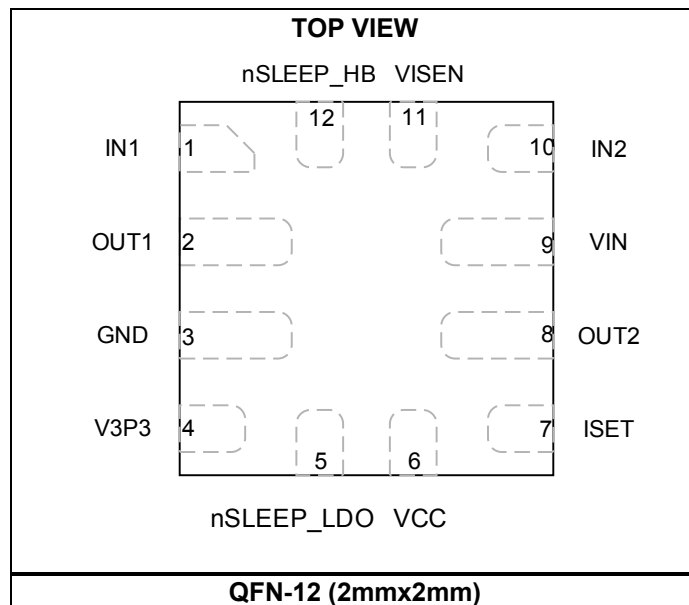

PIN FUNCTIONS

Pin #	Name	Description
1	IN1	Input 1. Internal pull-down resistor.
2	OUT1	Switch output 1. Connect OUT1 to the motor winding.
3	GND	Ground.
4	V3P3	3.3V regulator output. Bypass to GND with a 0.47 μ F capacitor.
5	nSLEEP_LDO	Sleep mode input of LDO output. Pull high for 3.3V LDO normal operation. Pull low to disable the LDO output and enter low-power sleep mode. Internal pull-down.
6	VCC	Internal circuitry supply bypass. Bypass VCC to GND with a 0.1 μ F to 10 μ F capacitor.
7	ISET	Current programming resistor. Connect a resistor to ground to set the current limit and VISEN output voltage.
8	OUT2	Switch output 2. Connect OUT2 to the motor winding.
9	VIN	Supply voltage. An input capacitor is needed to prevent large voltage spikes from appearing at the input.
10	IN2	Input 2. Internal pull-down resistor.
11	VISEN	Current-sense output voltage.
12	nSLEEP_HB	Sleep mode input of H-bridge. Pull high for H-bridge normal operation. Pull low to disable the H-bridge output and enter low-power sleep mode. Internal pull-down.

ABSOLUTE MAXIMUM RATINGS ⁽¹⁾

Supply voltage (V_{IN})	-0.3V to +24V
V_{OUTx}	-0.3V to $V_{IN} + 0.3V$
All other pins	-0.3 to +5V
Continuous power dissipation ($T_A = 25^\circ C$) ⁽²⁾	1.56W
Junction temperature	150 $^\circ C$
Lead temperature	260 $^\circ C$
Storage temperature	-65 $^\circ C$ to +150 $^\circ C$

Recommended Operating Conditions ⁽³⁾

Supply voltage (V_{IN})	1.8V to 22V
Operating junction temp (T_J)	-40 $^\circ C$ to +125 $^\circ C$

Thermal Resistance ⁽⁴⁾	θ_{JA}	θ_{JC}
QFN-12 (2mmx2mm)	80	16
	$^\circ C/W$	

Notes:

- Exceeding these ratings may damage the device.
- The maximum allowable power dissipation is a function of the maximum junction temperature T_J (MAX), the junction-to-ambient thermal resistance θ_{JA} , and the ambient temperature T_A . The maximum allowable continuous power dissipation at any ambient temperature is calculated by P_D (MAX) = $(T_J$ (MAX) - T_A) / θ_{JA} . Exceeding the maximum allowable power dissipation will cause excessive die temperature, and the regulator will go into thermal shutdown. Internal thermal shutdown circuitry protects the device from permanent damage.
- The device is not guaranteed to function outside of its operating conditions.
- Continuous current depends on PCB layout and ambient temperature.
- Measured on JESD51-7, 4-layer PCB.

ELECTRICAL CHARACTERISTICS

$V_{IN} = 5V$, $T_A = 25^\circ C$, unless otherwise noted.

Parameters	Symbol	Condition	Min	Typ	Max	Units
Power Supply						
Input supply voltage	V_{IN}		1.8		22	V
Operating supply current		no PWM, no load, nSLEEP_HB = 5V, nSLEEP_LDO = 0		0.85	1.1	mA
		50-kHz PWM, no load, nSLEEP_HB = 5V, nSLEEP_LDO = 0		1.2	1.5	mA
Operating supply current		$V_{IN} = 5V$ to 22V, $I_{V3P3} = 0A$, nSLEEP_HB = 0, nSLEEP_LDO = 5V		80	120	μA
Sleep mode supply current	I_Q	nSLEEP_HB = 0, nSLEEP_LDO = 0		10	120	nA
Under-voltage lockout threshold rising				1.68	1.8	V
Under-voltage lockout threshold hysteresis				150		mV
Externally applied PWM frequency	f_{PWM}				100	kHz
V3P3 Regulator						
LDO output		$V_{IN} > 3.7V$, $I_{OUT} = 0A$ to 50mA	3.1	3.3	3.5	V
Control Inputs (IN1, IN2, nSLEEP_HB, nSLEEP_LDO)						
Input high voltage	V_{IH}		1.6			V
Input low voltage	V_{IL}				0.4	V
Input high current	I_{IH}	$V_{IN} = 3.3V$			50	μA
Input low current	I_{IL}	$V_{IN} = 0V$	-5		+5	μA
Input pull-down resistance	RPD			520		k Ω
Motor Driver Outputs (OUT1, OUT2)						
HS switch on resistance	$R_{DS(ON)}$	$I_O = 800mA$, $T_A = 25^\circ C$		0.12	0.17	Ω
LS switch on resistance	$R_{DS(ON)}$	$I_O = 800mA$, $T_A = 25^\circ C$		0.12	0.17	Ω
Output enable time	t_1				200	ns
Output disable time	t_2				200	ns
Delay time	t_3	INx high to OUTx high			300	ns
	t_4	INx low to OUTx low			300	ns
Output rise time		$R_L = 20\Omega$			100	ns
Output fall time		$R_L = 20\Omega$			100	ns
Wake time, nSLEEP_HB rising edge to part H-bridge active	t_{WAKE}				200	μs
Dead time				100		ns
Current Control						
Off time	t_{ITRIP}	After ITRIP		17		μs
ISET current	I_{SET}		95	100	105	$\mu A/A$
Current trip voltage (rising)	$V_{ITRIP-R}$	At VISEN pin	475	500	525	mV
Current trip voltage (falling)	$V_{ITRIP-F}$	At VISEN pin	380	400	420	mV

ELECTRICAL CHARACTERISTICS (continued)
 $V_{IN} = 5V$, $T_A = 25^\circ C$, unless otherwise noted.

Parameters	Symbol	Condition	Min	Typ	Max	Units
VISEN Output						
Output voltage accuracy	ΔV_{VISEN}	$V_{ISET} > 0.1V$	-5		+5	%
Protection Circuits						
Current limit	I_{OCP}		4	5	6	A
OCP retry time	t_{OCR}			2.5		ms
Thermal shutdown threshold ⁽⁶⁾	T_{TSD}			160		$^\circ C$
Thermal shutdown hysteresis ⁽⁶⁾				25		$^\circ C$

Note:

6) Guaranteed by design.

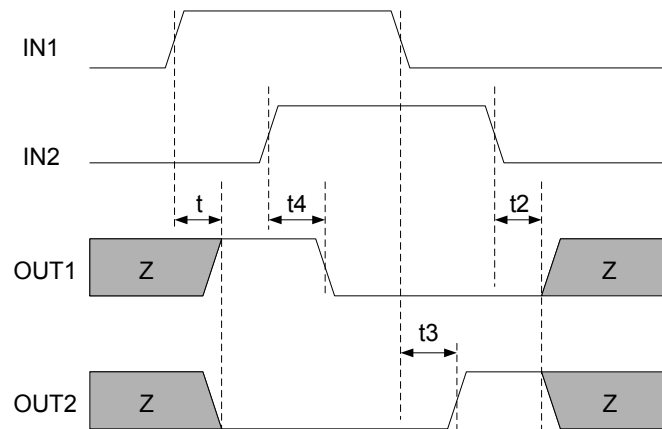
Figure 1: Input/Output Timing

TYPICAL CHARACTERISTICS

Current Sense ($I_{SET} = 2k\Omega$)

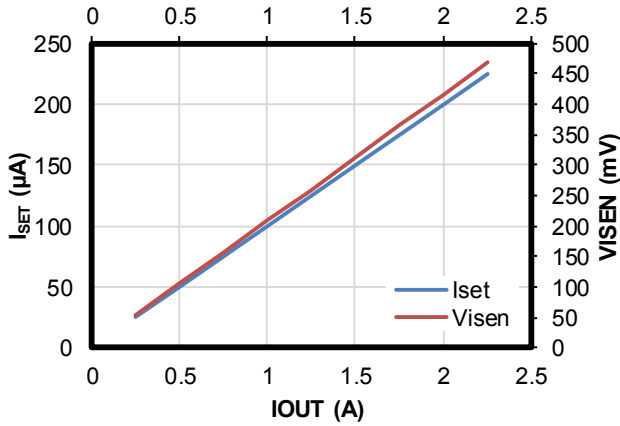

I_{SET} vs. Temperature

$I_{OUT} = 1A$

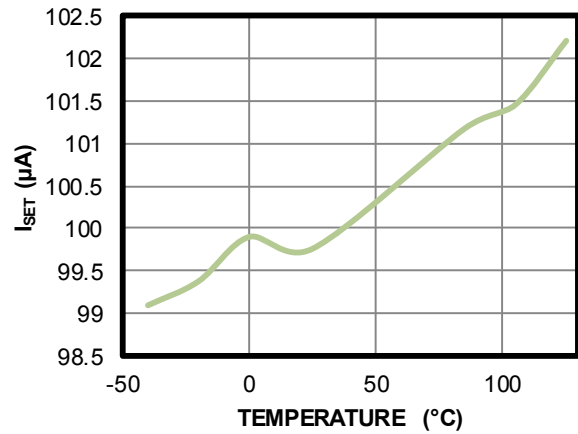

Current Trip Voltage (Rising) vs. Temperature

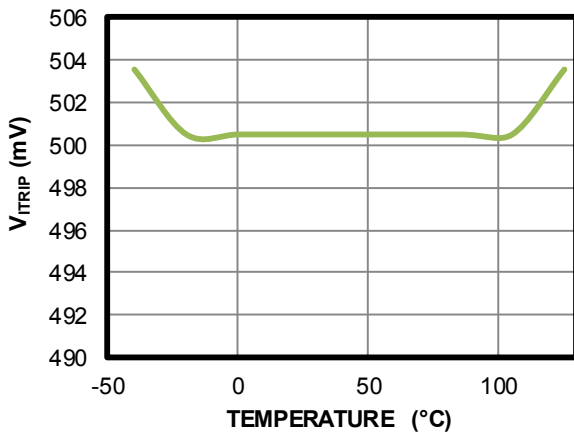

Current Trip Voltage (Falling) vs. Temperature

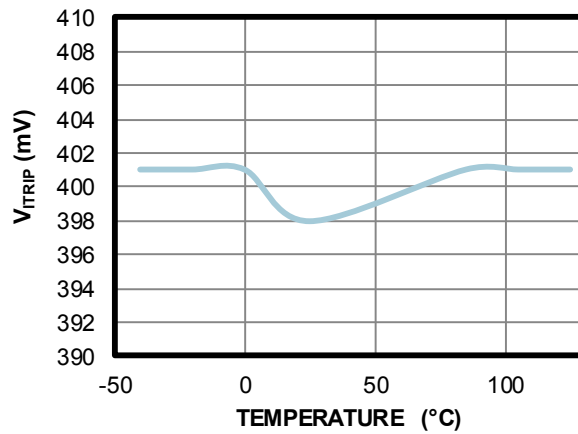

HS R_{ON} vs. Temperature

$I_{OUT} = 800mA$

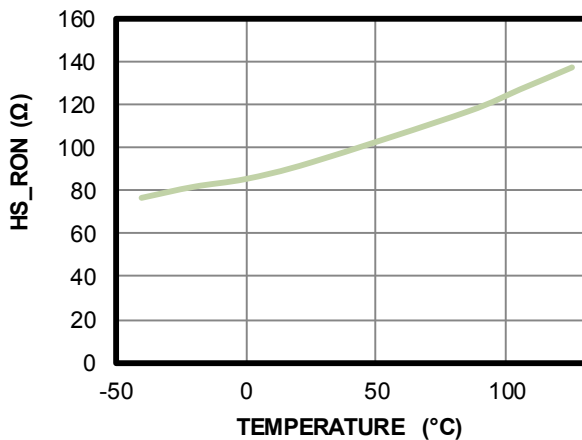

LS R_{ON} vs. Temperature

$I_{OUT} = 800mA$

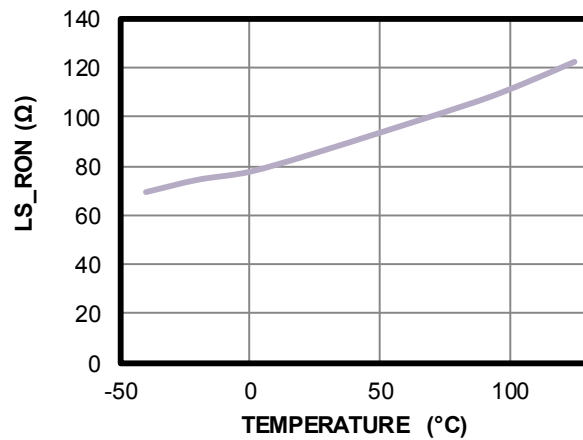

TYPICAL CHARACTERISTICS (continued)

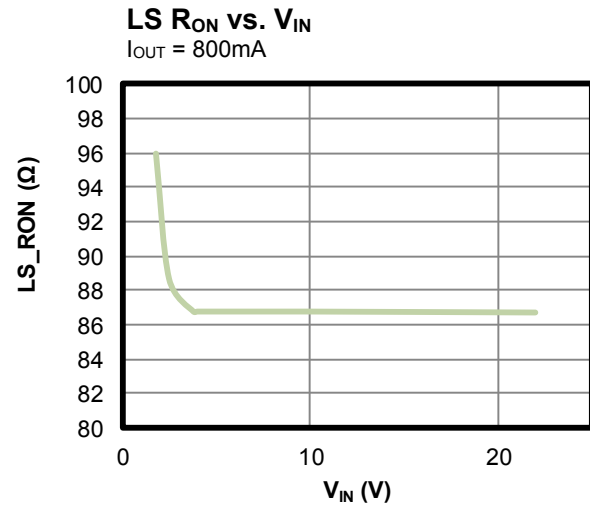
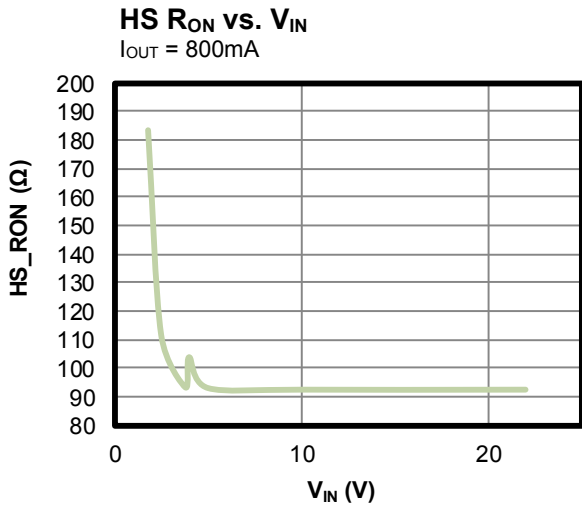

TYPICAL PERFORMANCE CHARACTERISTICS

$V_{IN} = 5V$, $T_A = 25^\circ C$, unless otherwise noted.

Normal Operation

IN1 = H, IN2 = L, $V_{IN} = 5V$, load = $2\Omega + 700\mu H$

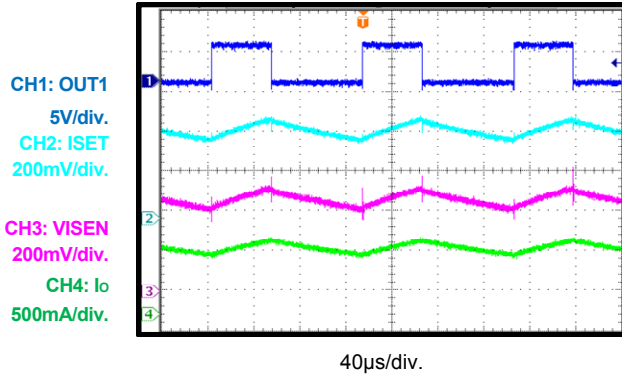

VIN Start-Up

IN1 = H, IN2 = L, $V_{IN} = 5V$, load = $2\Omega + 700\mu H$

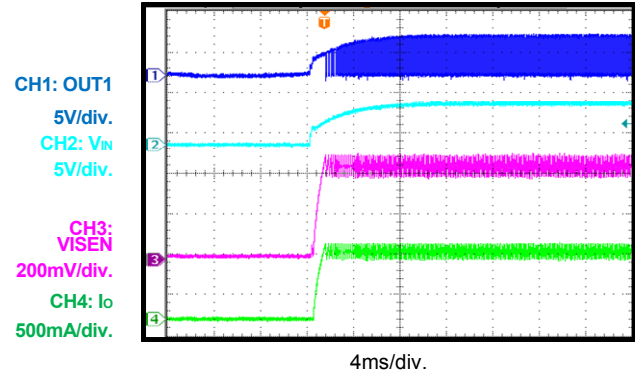

VIN Shutdown

IN1 = H, IN2 = L, $V_{IN} = 5V$, load = $2\Omega + 700\mu H$

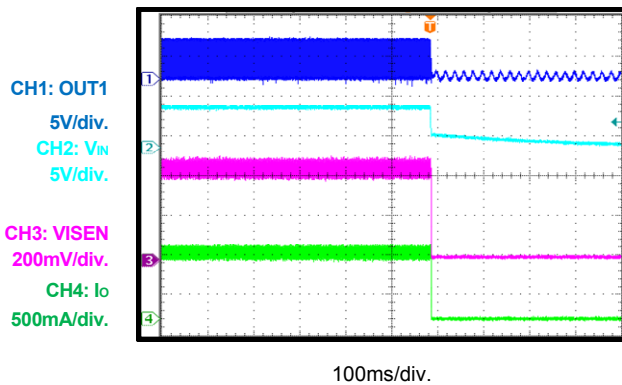

Sleep Start-Up

IN1 = H, IN2 = L, $V_{IN} = 5V$, load = $2\Omega + 700\mu H$

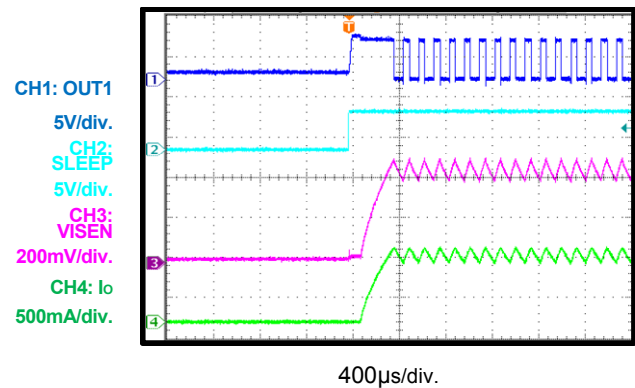

Sleep Shutdown

IN1 = H, IN2 = L, $V_{IN} = 5V$, load = $2\Omega + 700\mu H$

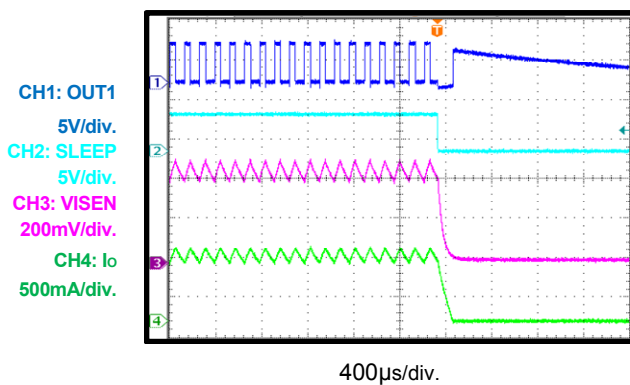

SCP-OUT Short to V_{IN}

IN1 = H, IN2 = L, $V_{IN} = 22V$

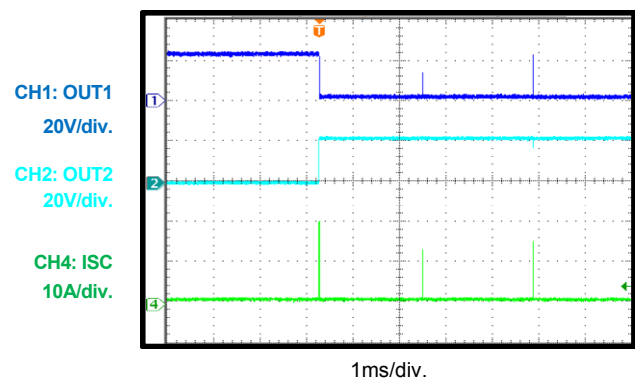

TYPICAL PERFORMANCE CHARACTERISTICS (continued)

$V_{IN} = 5V$, $T_A = 25^{\circ}C$, unless otherwise noted.

SCP-OUT Short to GND

IN1 = H, IN2 = L, $V_{IN} = 22V$

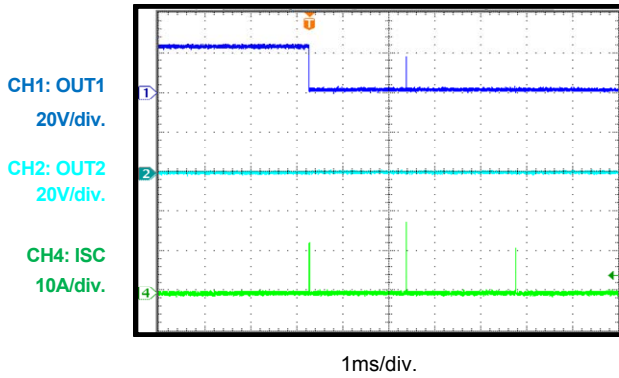

SCP-OUT Short to OUT

IN1 = H, IN2 = L, $V_{IN} = 22V$

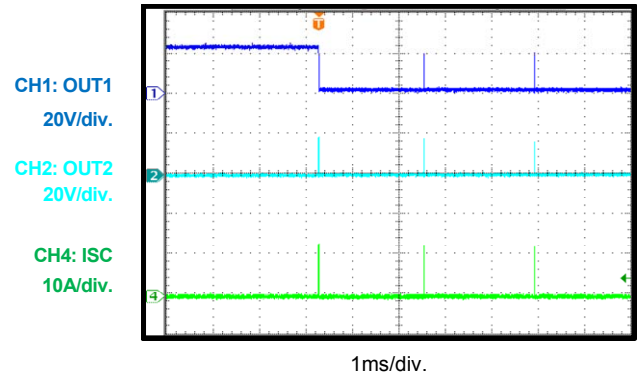

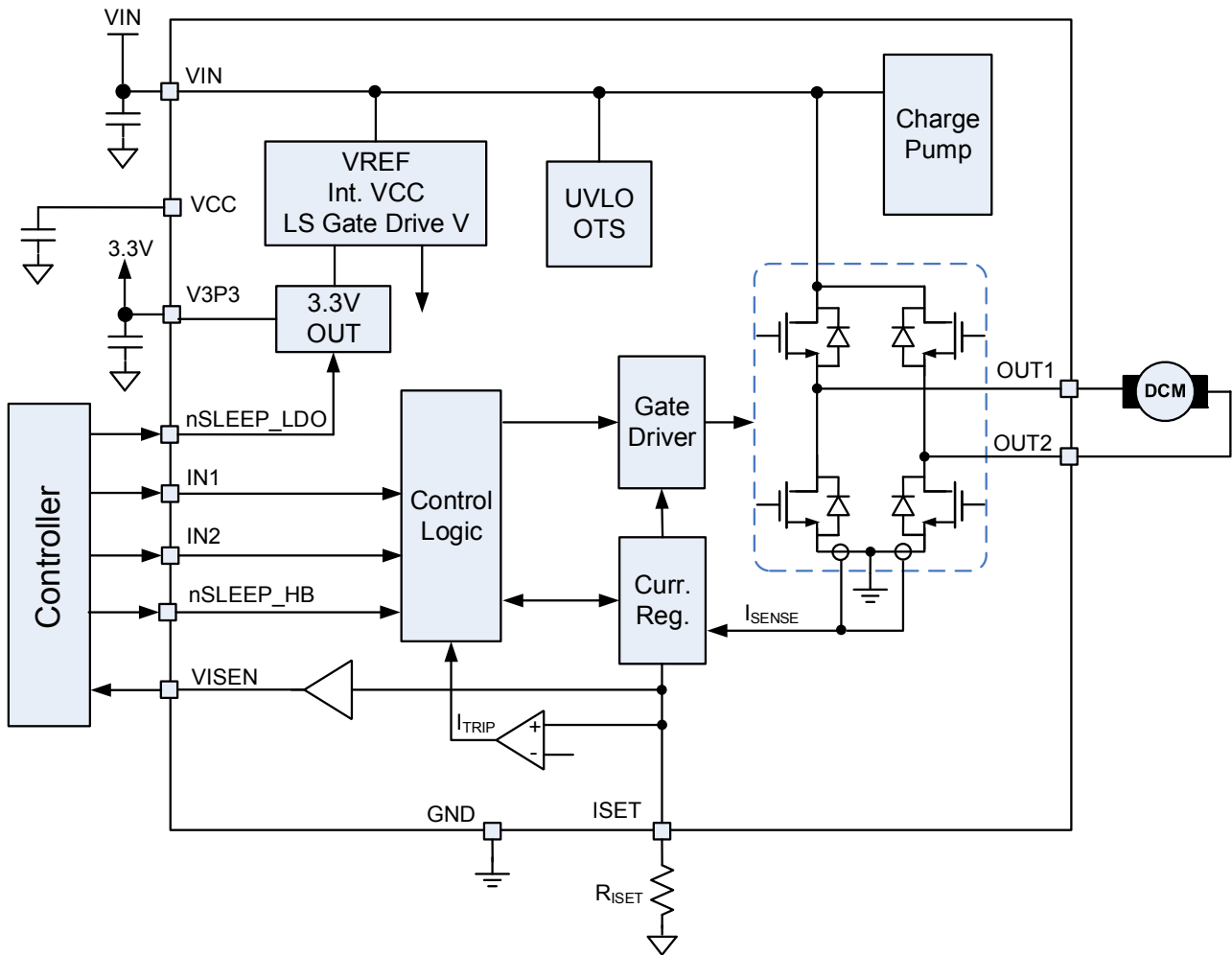
SINGLE-CHANNEL BLOCK DIAGRAM

Figure 2: Single-Channel Block Diagram

OPERATION

Bridge Control

The MP6550 is controlled using a PWM input interface, which is compatible with industry-standard devices. Each output is controlled by a corresponding input pin.

The following table shows the logic for the MP6550:

Table 1: Input Logic Truth Table

IN1	IN2	OUT1	OUT2	Function (DC Motor)
L	L	Z	Z	Coast
L	H	L	H	Reverse
H	L	H	L	Forward
H	H	L	L	Brake

Table 2 shows the recommended PWM input control for a DC motor driver.

Table 2: PWM Input Control

IN1	IN2	OUT1	OUT2	Function (DC Motor)
H	PWM	L	H	Forward
		H	L	Slow decay
PWM	L	H	L	Reverse
	H		L	Slow decay

Current Sensing

The current flowing in the two low-side MOSFETs is sensed with an internal current-sensing circuit. A voltage proportional to the output current is sourced on the VISEN pin.

The VISEN output voltage scaling is set by a resistor connected between the ISET pin and ground. For 1A of output current, 100µA of current is sourced into the resistor connected to VISEN. For example, if a 5kΩ resistor is connected between ISET and ground, the output voltage on the VISEN pin will be 0.5V/A of output current.

Current is sensed any time one of the low-side MOSFETs is turned on, including during slow decay (brake) mode.

The load current applied to the VISEN pin should be kept below 2mA, with no more than 500pF of capacitance.

Current Limit / Regulation

The current in the outputs is limited using constant-off-time PWM (pulse-width modulation) control circuitry. Figure 3 shows this operation.

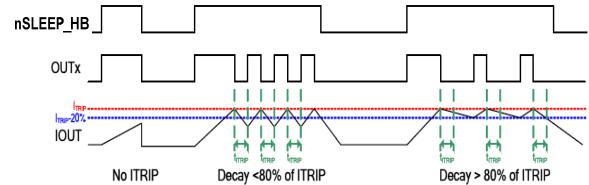

Figure 3: Current Limit Operation

Initially, a diagonal pair of MOSFETs turns on and drives current through the load. The current increases in the load, which is sensed by the internal current-sense circuit.

If the load current reaches the current trip threshold, the H-bridge switches to slow decay mode, and the two low-side MOSFETs turn on.

After a fixed off time (t_{ITRIP}), if the load current has fallen at least 20% below the current limit threshold, the FETs are re-enabled and the cycle repeats. If the current remains above this level, the off time is extended until the current falls to 20% below the current limit threshold.

The current limit threshold is reached when the VISEN pin reaches 0.5V. For example, with a 5kΩ resistor from ISET to ground, the VISEN voltage is about 0.5V/A of output current. So when the current reaches 1A, the VISEN pin voltage reaches 0.5V, and a current trip occurs.

During current regulation, the nFAULT pin is not activated.

Blanking Time

There is often a current spike during start-up due to the body diode's reverse-recovery current or the shunt capacitance of the load. This current spike requires filtering to prevent it from erroneously shutting down the high-side MOSFET. An internal fixed blanking time (t_{OCPD}) blanks the output of the current sense comparator when the outputs are switched. This blanking time also sets the minimum on time for high-side MOSFET.

nSLEEP Operation

The MP6550 has one H-bridge driver and a 3.3V reference output, which can be separately put into a low-power sleep state. Driving nSLEEP_HB low turns the H-bridge outputs off and disables all related internal circuits, including the gate drive charge pump. All inputs are ignored when nSLEEP_HB is active low. Driving nSLEEP_LDO low disables the 3.3V regulator. When waking up from sleep mode, some time needs to pass before the outputs will operate.

Protection Circuits

The MP6550 is fully protected against under-voltage, over-current, and over-temperature events.

Over-Current Protection (OCP)

The MP6550 has internal overload and short-circuit protection. The currents in both the high-

side and low-side MOSFETs are measured and if the current exceeds the current limit, all MOSFETs in the H-bridge are turned off. After approximately 1ms, the bridge is automatically re-enabled.

Thermal Shutdown (TSD)

Thermal monitoring is also integrated into the MP6550. If the die temperature exceeds 160°C, all switches turn off. Once the die temperature has fallen to a safe level, operation resumes automatically.

Under-Voltage Lockout (UVLO)

If at any time the voltage on the VIN pin falls below the under-voltage lockout (UVLO) threshold voltage, all circuitry in the device is disabled and the internal logic is reset. Normal operation resumes when VIN exceeds the UVLO threshold.

PACKAGE INFORMATION

QFN-12 (2mmx2mm)

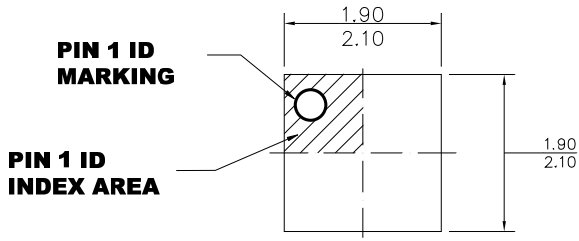

TOP VIEW

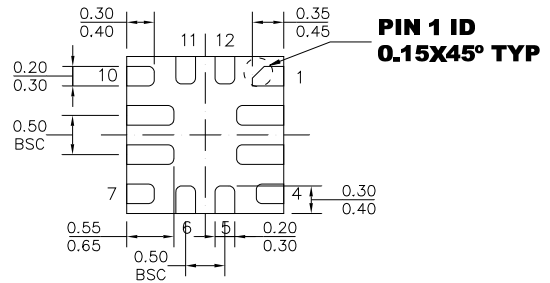

BOTTOM VIEW

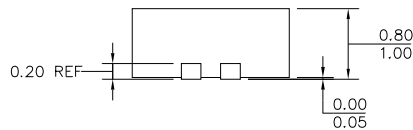

SIDE VIEW

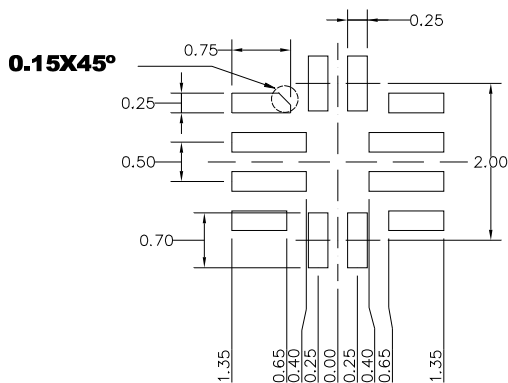

RECOMMENDED LAND PATTERN

NOTE:

- 1) ALL DIMENSIONS ARE IN MILLIMETERS.
- 2) LEAD COPLANARITY SHALL BE 0.08 MILLIMETERS MAX.
- 3) JEDEC REFERENCE IS MO-220.
- 4) DRAWING IS NOT TO SCALE.

NOTICE: The information in this document is subject to change without notice. Please contact MPS for current specifications. Users should warrant and guarantee that third-party Intellectual Property rights are not infringed upon when integrating MPS products into any application. MPS will not assume any legal responsibility for any said applications.