



The Future of Analog IC Technology™

MP8103

Dual Ultra Low Power
1.8V, 600kHz Op Amp

DESCRIPTION

The MP8103 is a single supply, dual rail-to-rail output operational amplifier. This amplifier provides 600kHz bandwidth while consuming an incredibly low 14µA of supply current. The MP8103 can operate with a single supply voltage as low as 1.8V. The input common mode can go below the negative rail. The maximum supply voltage is 5.5V which allows the device to operate from ±0.9V to ±2.75V or a single supply. The MP8103 is available in an 8-pin 3mm x 5mm MSOP package.

FEATURES

- Single Supply Operation: 1.8V to 5.5V
- 600kHz -3dB Bandwidth
- 14µA Supply Current
- Rail-to-Rail Output
- Unity-Gain Stable
- Input Common Mode to Ground
- Drives Up to 1000pF of Capacitive Loads
- High Slew Rate: 0.1V/µs
- Available in a MSOP8 Package

APPLICATIONS

- Portable Equipment
- PDAs
- Pagers
- Cordless Phones
- Handheld GPS
- Consumer Electronics
- Smoke Detector
- Portable Medical Equipment

"MPS" and "The Future of Analog IC Technology" are Registered Trademarks of Monolithic Power Systems, Inc.

TYPICAL APPLICATION

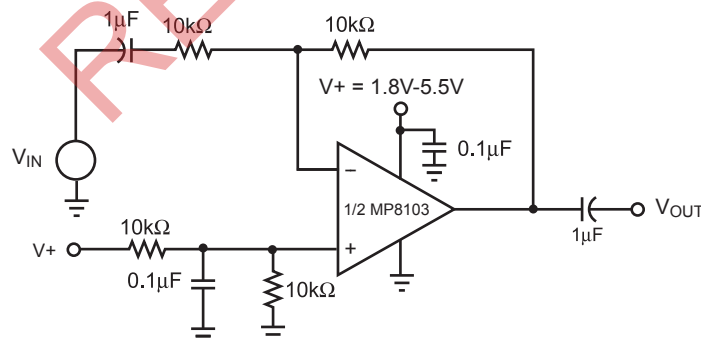

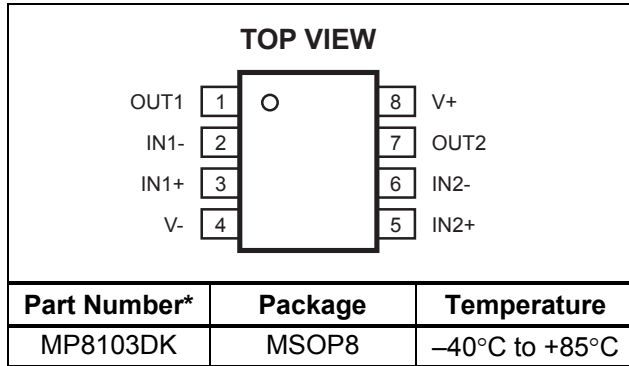
PACKAGE REFERENCE

* For Tape & Reel, add suffix -Z (eg. MP8103DK-Z)
 For RoHS Compliant Packaging, add suffix -LF (eg. MP8103DK-LF-Z)

ABSOLUTE MAXIMUM RATINGS ⁽¹⁾

Supply Voltage (V+ to V-) +6.0V
 Differential Input Voltage ($V_{IN+} - V_{IN-}$) +6.0V
 Input Voltage ($V_{IN+} - V_{IN-}$).. $V_{IN+} + 0.3V$, $V_{IN-} - 0.3V$

Recommended Operating Conditions ⁽²⁾

Supply Voltage +1.8V to +5.5V
 Operating Temperature -40°C to +85°C

Thermal Resistance ⁽³⁾

θ_{JA} θ_{JC}
 MSOP8 150 65... °C/W

Notes:

- 1) Exceeding these ratings may damage the device.
- 2) The device is not guaranteed to function outside of its operating conditions.
- 3) Measured on approximately 1" square of 1 oz copper.

ELECTRICAL CHARACTERISTICS

$V_+ = +5V$, $V_- = 0V$, $V_{CM} = V_+/2$, $R_L = 10k\Omega$, $T_A = +25^\circ C$, unless otherwise noted.

Parameter	Symbol	Condition	Min	Typ	Max	Units
Input Offset Voltage	V_{OS}		-5	1	+5	mV
Input Offset Voltage Temp Coefficient				15		$\mu V/^\circ C$
Input Bias Current ⁽⁴⁾	I_B			2		pA
Input Offset Current ⁽⁴⁾	I_{OS}			0.2		pA
Input Voltage Range	V_{CM}	CMRR > 60dB	0		3.8	V
Common-Mode Rejection Ratio	CMRR	$0 < V_{CM} < 3.5V$		82		dB
Power Supply Rejection Ratio	PSRR	Supply Voltage change of 1.0V		80		dB
Large Signal Voltage Gain	A_{VOL}	$R_L = 100k\Omega$, $V_{OUT} = 5.0$ Peak to Peak	60	88		dB
Maximum Output Voltage Swing	V_{OUT}	$R_L = 10k\Omega$		$V_+ - 23mV$		V
Minimum Output Voltage Swing	V_{OUT}	$R_L = 10k\Omega$		$V_- + 19mV$		V
Gain-Bandwidth Product ⁽⁴⁾	GBW	$R_L = 200k\Omega$, $C_L = 2pF$, $V_{OUT} = 0$		200		KHz
-3dB Bandwidth	BW	$A_V = 1$, $C_L = 2pF$, $R_L = 1M\Omega$		600		KHz
Slew Rate ⁽⁴⁾	SR	$A_V = 1$, $C_L = 2pF$, $R_L = 1M\Omega$		0.1		V/ μs
Short Circuit Current	I_{SC}	Source		20		mA
		Sink		20		mA
Supply Current		No Load		14	22	μA

Note:

4) Guaranteed by design.

PIN FUNCTIONS

Pin #	Name	Description
1	OUT1	Output of First Op-Amp..
2	IN1-	Inverting Input of First Op-Amp.
3	IN1+	Non-Inverting Input of First Op-Amp.
4	V-	Ground or Supply Return Pin.
5	IN2+	Non-Inverting Input of Second Op-Amp.
6	IN2-	Inverting Input of Second Op-Amp.
7	OUT2	Output of Second Op-Amp.
8	V+	Supply Voltage.

TEST CIRCUITS

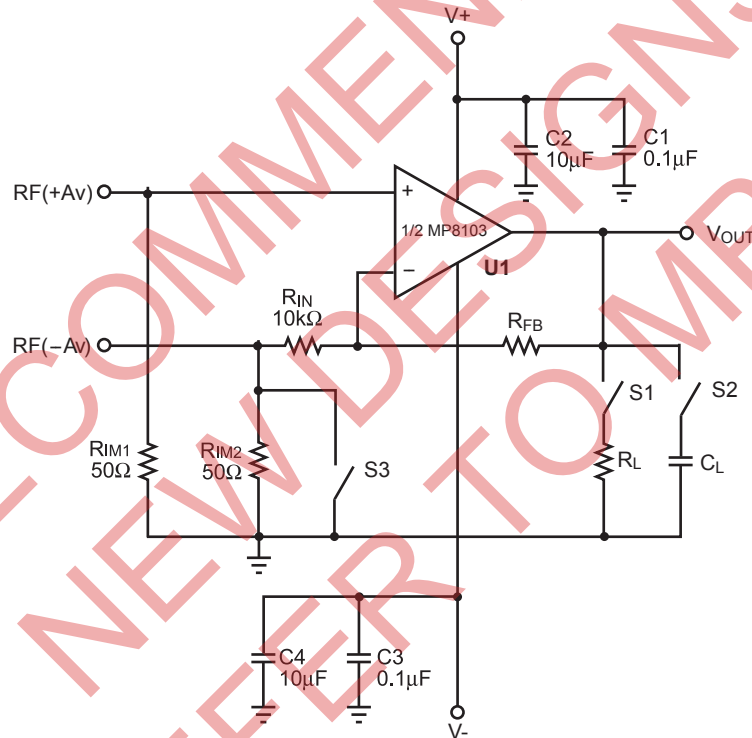

Notes: Close S3 for positive gain. Input signal to RF(+Av) connector.
 The gain $A_v = 1 + R_{FB}/R_{IN}$.
 For unity gain, remove R_{IN} and short R_{FB} .
 Open S3 for negative gain. Input signal to RF(-Av) connector.
 The gain $A_v = -R_{FB}/R_{IN}$.
 S1 and S2 are switches for possible resistor and capacitor load connections.

Figure 1—AC Test Circuit

TEST CIRCUITS (continued)

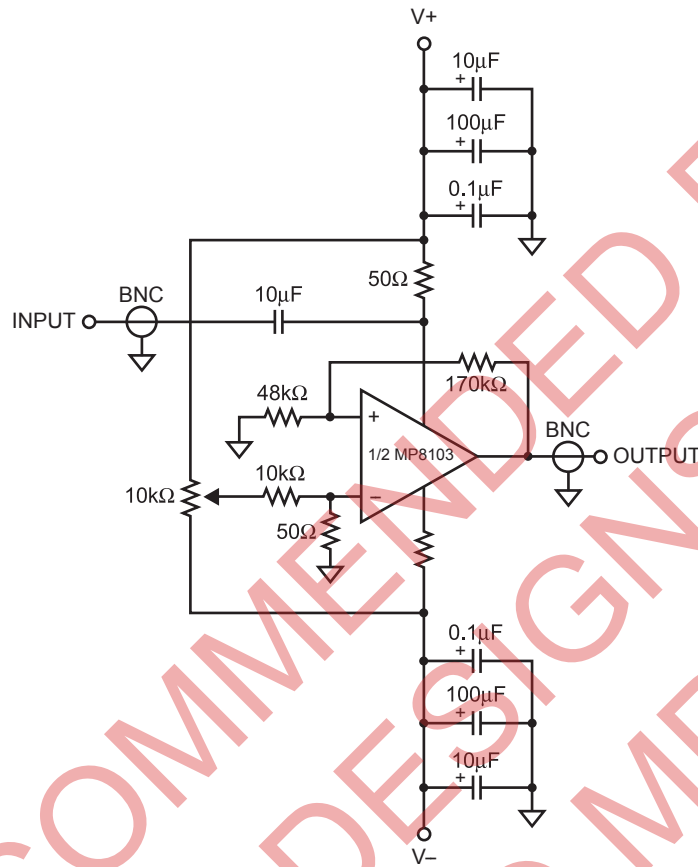
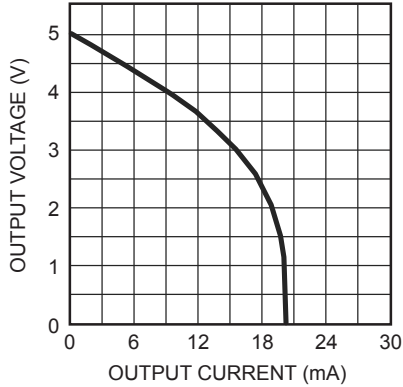

Figure 2—Positive Power Supply Rejection Ratio Measurement

TYPICAL PERFORMANCE CHARACTERISTICS

T_A = +25°C, unless otherwise noted.

Output Voltage vs. Output Current
Sourcing



Output Voltage vs. Output Current
Sinking

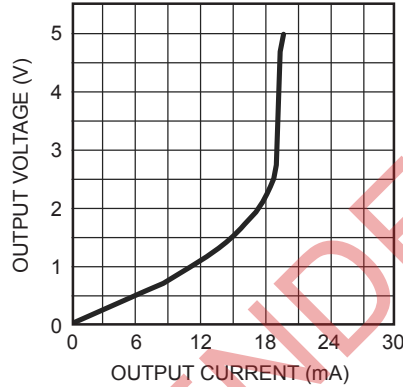

Short Circuit Current vs. Supply Voltage
Sourcing

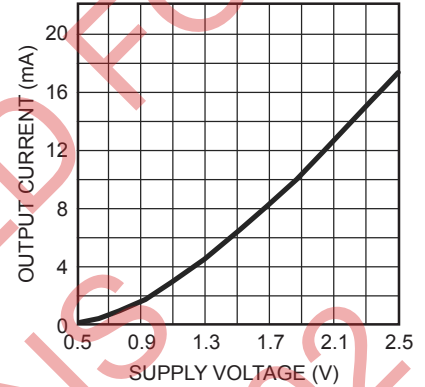

Short Circuit Current vs. Supply Voltage
Sinking

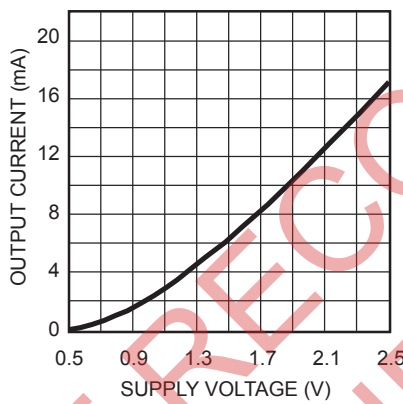

Offset Voltage vs. Common Mode Voltage
R_{FB} = 50kΩ, V₋ = -5V to 0V, V₊ = 0V to +5V

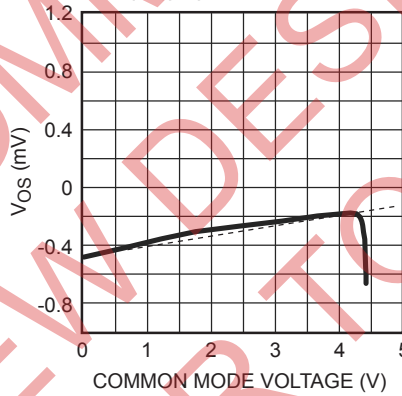

Offset Voltage vs. Supply Voltage
R_{FB} = 50kΩ, V₋ = -2.5V to 0V, V₊ = +2.5V to 0V

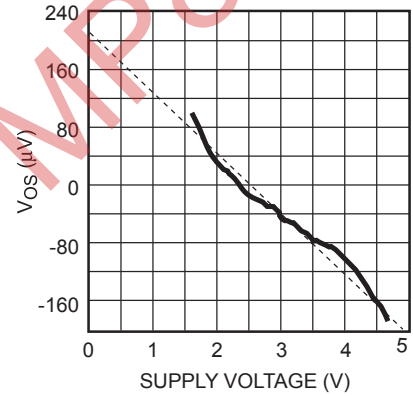

TYPICAL PERFORMANCE CHARACTERISTICS (continued)

$T_A = +25^\circ\text{C}$, unless otherwise noted.

Gain Bandwidth and Phase Margin

$V_{+/-} = +/-1.35\text{V}$, Gain = 1, $R_L = 1\text{M}\Omega$

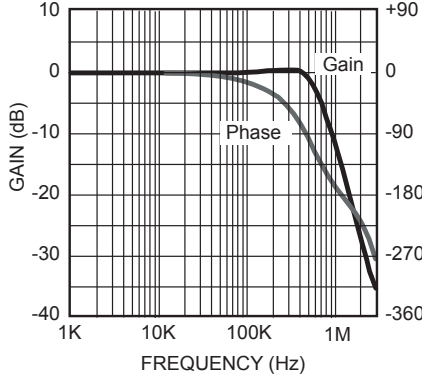

Gain Bandwidth and Phase Margin

$V_{+/-} = +/-2.50\text{V}$, Gain = 1, $R_L = 1\text{M}\Omega$

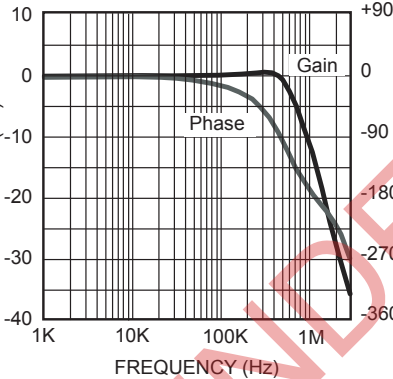

Gain Bandwidth and Phase Margin

$V_{+/-} = +/-1.35\text{V}$, Gain = 2, $R_L = 1\text{M}\Omega$

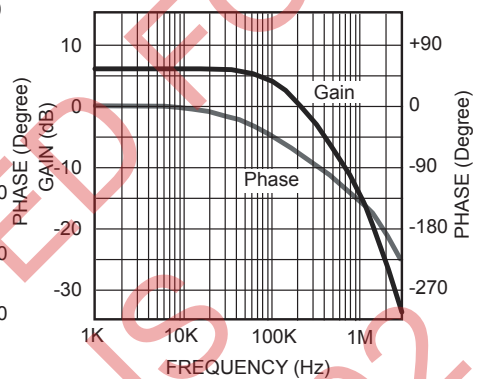

Gain Bandwidth and Phase Margin

$V_{+/-} = +/-2.50\text{V}$, Gain = 2, $R_L = 1\text{M}\Omega$

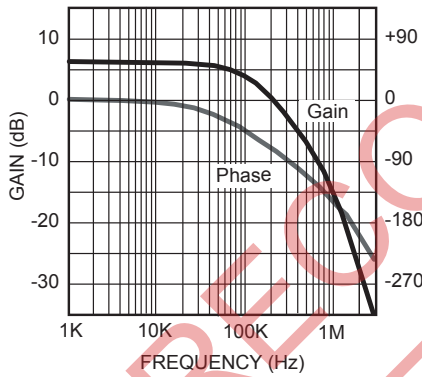

Gain Bandwidth and Phase Margin

$V_{+/-} = +/-1.35\text{V}$, Gain = 10, $R_L = 1\text{M}\Omega$

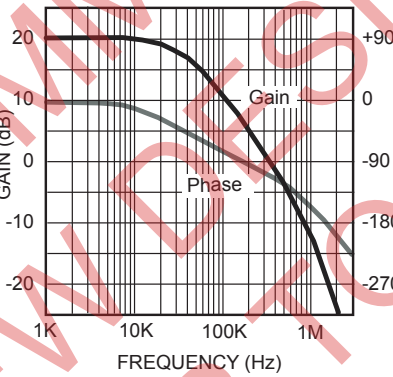

Gain Bandwidth and Phase Margin

$V_{+/-} = +/-2.50\text{V}$, Gain = 10, $R_L = 1\text{M}\Omega$

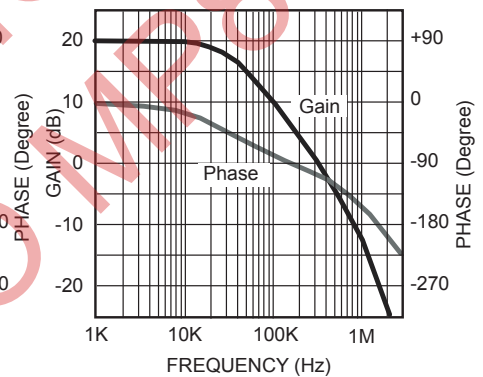

Close-Loop Unity Gain Frequency Response

$V_{+/-} = +/-2.50\text{V}$, Gain = 1

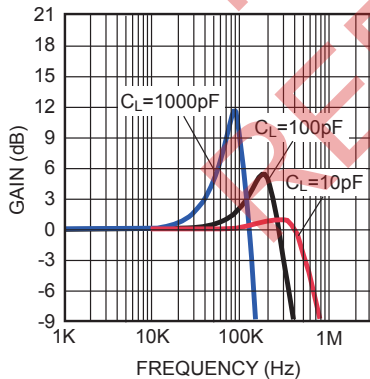

PSRR vs. Frequency

$V_- = -2.5\text{V}$, $V_+ = 2.5\text{V}$

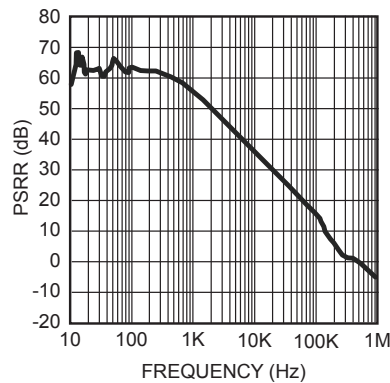

TYPICAL PERFORMANCE CHARACTERISTICS *(continued)*

$T_A = +25^\circ\text{C}$, unless otherwise noted.

Small Signal Pulse Response

$A_V = 1$, $V_+ = 2.5\text{V}$, $V_- = -2.5\text{V}$
 $R_L = 1\text{M}\Omega$, $C_L = 8\text{pF}$

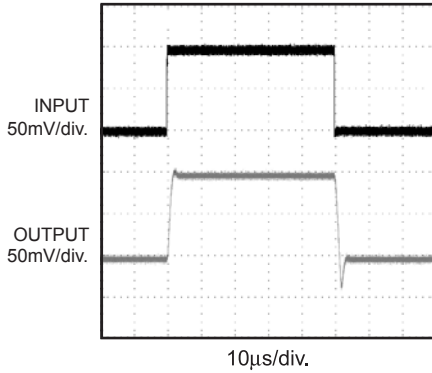

Small Signal Pulse Response

$A_V = 1$, $V_+ = 1.25\text{V}$, $V_- = -1.25\text{V}$
 $R_L = 1\text{M}\Omega$, $C_L = 8\text{pF}$

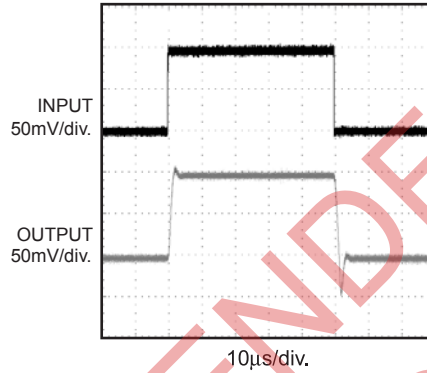

Small Signal Pulse Response

$A_V = 1$, $V_+ = 2.5\text{V}$, $V_- = -2.5\text{V}$
 $R_L = 1\text{M}\Omega$, $C_L = 50\text{pF}$

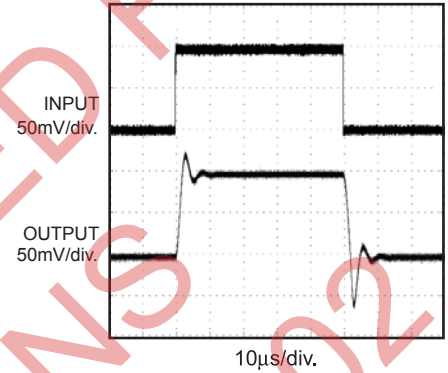

Small Signal Pulse Response

$A_V = 1$, $V_+ = 1.25\text{V}$, $V_- = -1.25\text{V}$
 $R_L = 1\text{M}\Omega$, $C_L = 50\text{pF}$

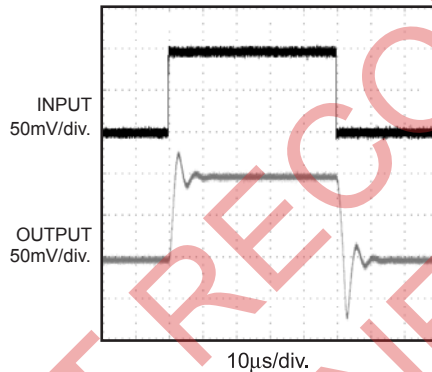

Small Signal Pulse Response

$A_V = -1$, $V_+ = 2.5\text{V}$, $V_- = -2.5\text{V}$
 $R_L = 1\text{M}\Omega$, $C_L = 8\text{pF}$

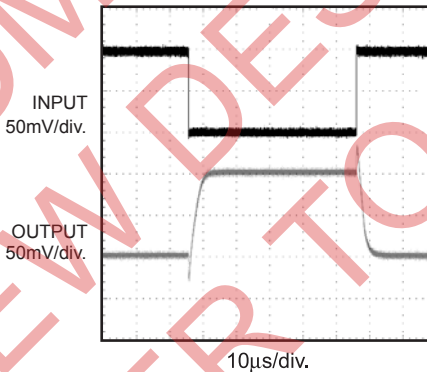

Small Signal Pulse Response

$A_V = -1$, $V_+ = 1.25\text{V}$, $V_- = -1.25\text{V}$
 $R_L = 1\text{M}\Omega$, $C_L = 8\text{pF}$

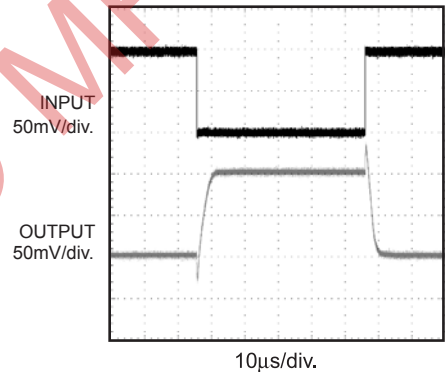

Small Signal Pulse Response

$A_V = -1$, $V_+ = 2.5\text{V}$, $V_- = -2.5\text{V}$
 $R_L = 5\text{k}\Omega$, $C_L = 8\text{pF}$

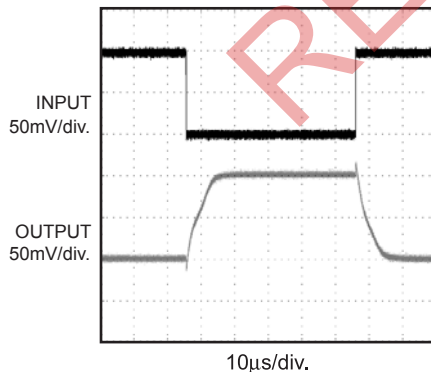

Small Signal Pulse Response

$A_V = -1$, $V_+ = 1.25\text{V}$, $V_- = -1.25\text{V}$
 $R_L = 5\text{k}\Omega$, $C_L = 8\text{pF}$

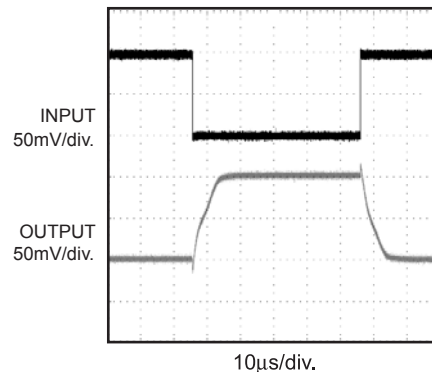

TYPICAL PERFORMANCE CHARACTERISTICS (continued)
 $T_A = +25^\circ\text{C}$, unless otherwise noted.

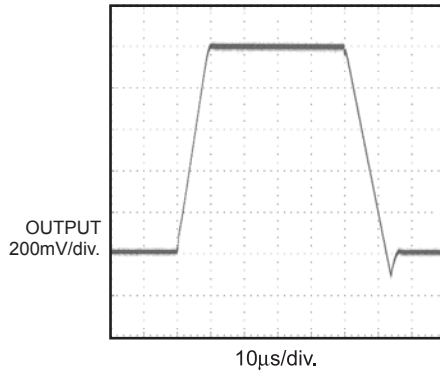
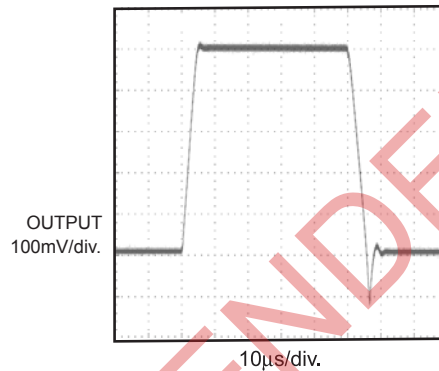
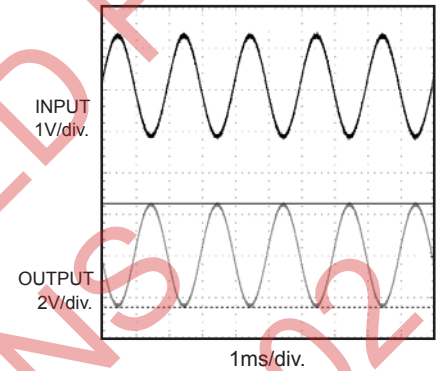
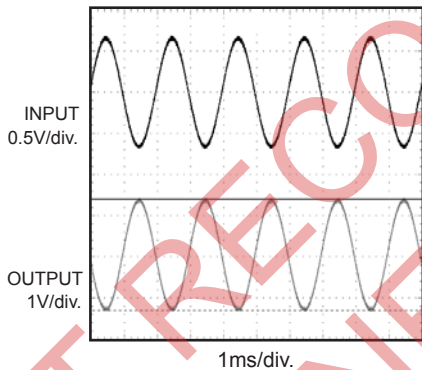
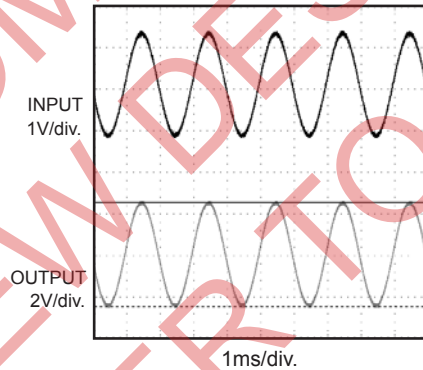
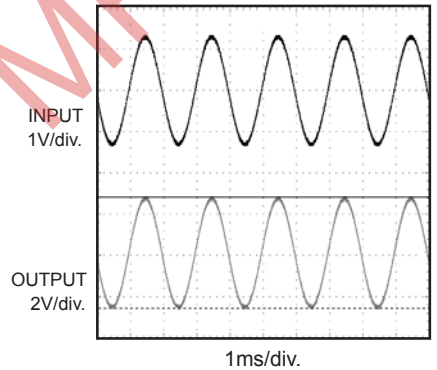
Large Signal Pulse Response
 $A_V = 1, V_+ = 2.5\text{V}, V_- = -2.5\text{V}$
 $R_L = 1\text{M}\Omega, C_L = 8\text{pF}$

Large Signal Pulse Response
 $A_V = 1, V_+ = 1.25\text{V}, V_- = -1.25\text{V}$
 $R_L = 1\text{M}\Omega, C_L = 8\text{pF}$

Rail to Rail Output Operation
 $A_V = -2, V_+ = 2.5\text{V}, V_- = -2.5\text{V}$
 $R_L = 1\text{M}\Omega, C_L = 8\text{pF}$

Rail to Rail Output Operation
 $A_V = -2, V_+ = 1.25\text{V}, V_- = -1.25\text{V}$
 $R_L = 1\text{M}\Omega, C_L = 8\text{pF}$

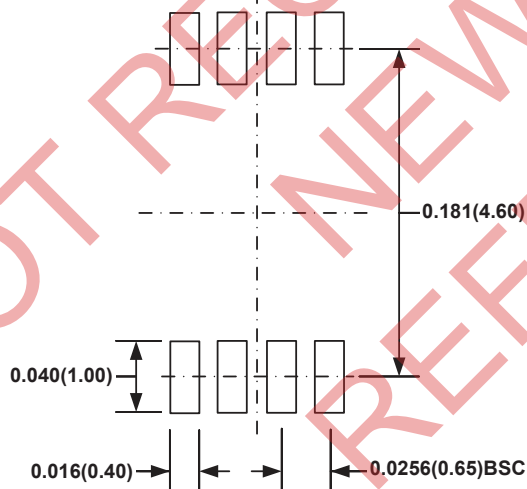
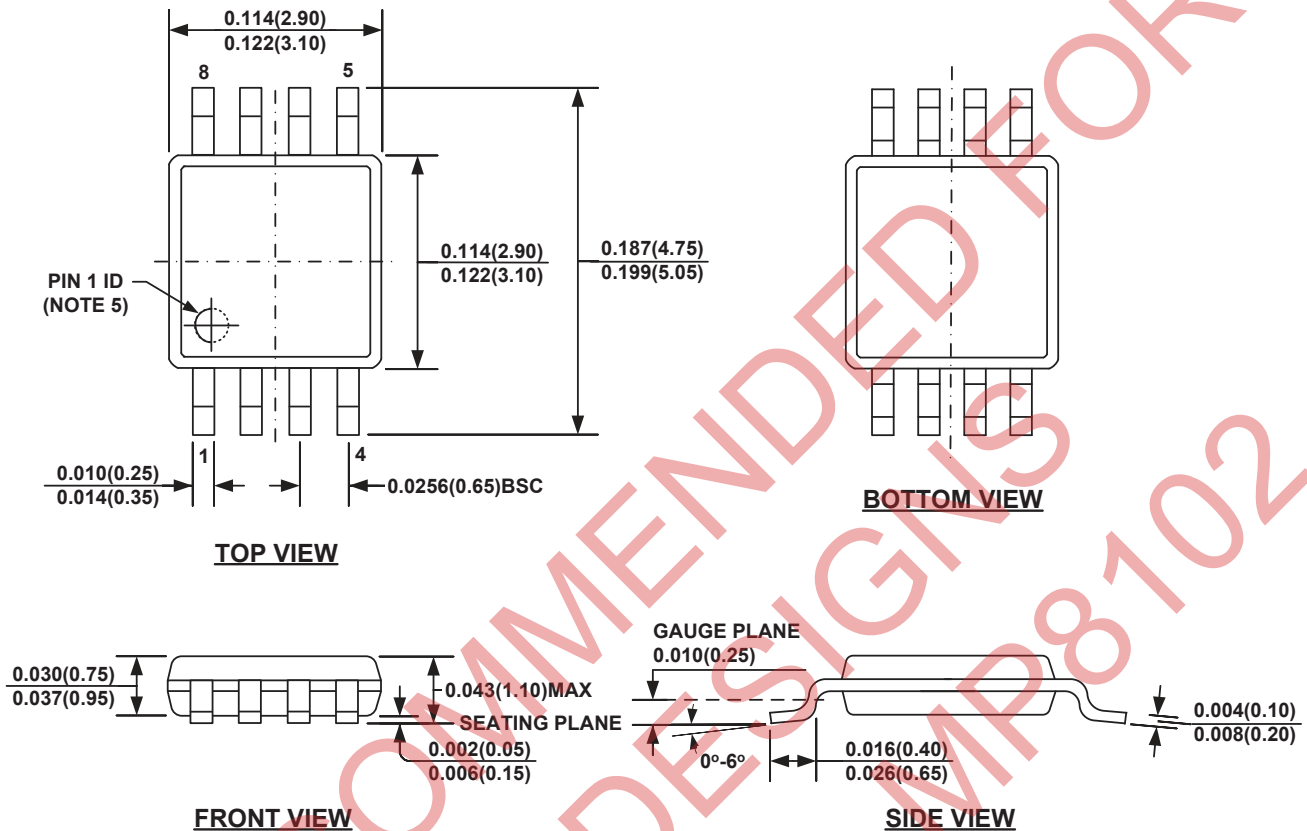
Rail to Rail Output Operation
 $A_V = 2, V_+ = 2.5\text{V}, V_- = -2.5\text{V}$
 $R_L = 1\text{M}\Omega, C_L = 8\text{pF}$

Rail to Rail Output Operation
 $A_V = 2, V_+ = 1.25\text{V}, V_- = -1.25\text{V}$
 $R_L = 1\text{M}\Omega, C_L = 8\text{pF}$

APPLICATION INFORMATION
Power Supply Bypassing

Regular supply bypassing techniques are recommended. A $10\mu\text{F}$ capacitor in parallel with a $0.1\mu\text{F}$ capacitor on both the positive and negative supplies is ideal. For the best performance, all bypassing capacitors should be located as close to the op amp as possible and all capacitors should be low ESL (Equivalent Series Inductance) and low ESR (Equivalent Series Resistance). Surface mount ceramic capacitors are ideal.

PACKAGE INFORMATION

MSOP8



NOTE:

- 1) CONTROL DIMENSION IS IN INCHES. DIMENSION IN BRACKET IS IN MILLIMETERS.
- 2) PACKAGE LENGTH DOES NOT INCLUDE MOLD FLASH, PROTRUSION OR GATE BURR.
- 3) PACKAGE WIDTH DOES NOT INCLUDE INTERLEAD FLASH OR PROTRUSION.
- 4) LEAD COPLANARITY (BOTTOM OF LEADS AFTER FORMING) SHALL BE 0.004" INCHES MAX.
- 5) PIN 1 IDENTIFICATION HAS HALF OR FULL CIRCLE OPTION.
- 6) DRAWING MEETS JEDEC MO-187, VARIATION AA.
- 7) DRAWING IS NOT TO SCALE.

NOTICE: The information in this document is subject to change without notice. Users should warrant and guarantee that third party Intellectual Property rights are not infringed upon when integrating MPS products into any application. MPS will not assume any legal responsibility for any said applications.