

DESCRIPTION

The MP8352 is a monolithic step-down switch mode converter with a built in internal power MOSFET. It achieves 6A continuous output current over a wide input supply range with excellent load and line regulation.

Current mode operation provides fast transient response and eases loop stabilization.

Fault condition protection includes cycle-by-cycle current limiting and thermal shutdown.

The MP8352 requires a minimum number of readily available standard external components and is available in a space saving 3mm x 4mm 14-pin QFN package.

FEATURES

- 3V to 6V Operating Input Range
- 6A Continuous Output Current
- 45mΩ Internal Power MOSFET Switch
- External Power Supply V_{CC}
- Power Good Indicator
- Synchronous Gate Driver Delivers up to 95% Efficiency
- Fixed 600KHz Frequency
- Synchronizable Up to 1.5MHz
- Cycle-by-Cycle Over Current Protection with Hiccup
- Thermal Shutdown
- Output Adjustable from 0.8V
- Stable with Low ESR Output Ceramic Capacitors
- Available in a 3mm x 4mm 14-Pin QFN Package

APPLICATIONS

- Point of Load Regulator in Distributed Power System
- Digital Set Top Boxes
- Personal Video Recorders
- Broadband Communications
- Flat Panel Television and Monitors

*MPS[®] and "The Future of Analog IC Technology" are Registered Trademarks of Monolithic Power Systems, Inc.

TYPICAL APPLICATION

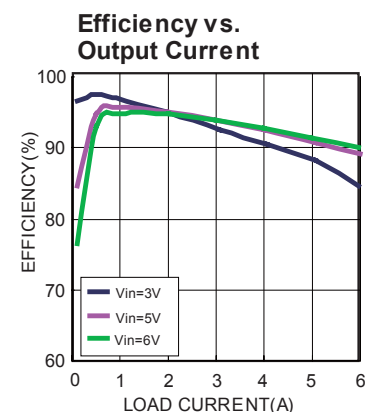
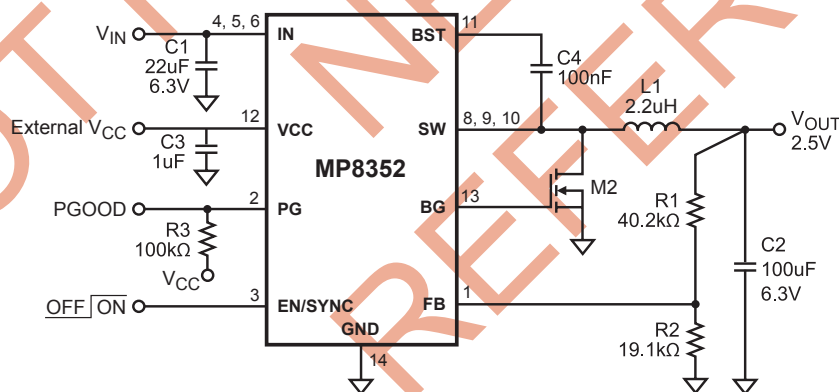

ORDERING INFORMATION

Part Number*	Package	Top Marking	Free Air Temperature (T _A)
MP8352DL	3x4 QFN14	8352	-40°C to +85°C

* For Tape & Reel, add suffix -Z (eg. MP8352DL-Z).
 For RoHS compliant packaging, add suffix -LF (eg. MP8352DL-LF-Z)

PACKAGE REFERENCE

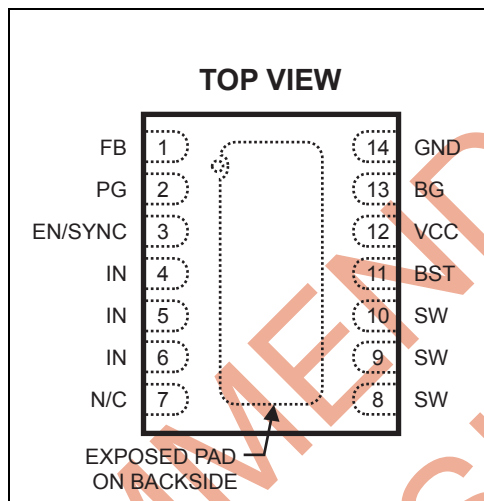

ABSOLUTE MAXIMUM RATINGS ⁽¹⁾

Supply Voltage V_{IN} 6.5V
 V_{SW} -0.3V(-5V for < 10ns) to 7.5V
 V_{BS}-V_{SW} 6V
 All Other Pins -0.3V to +6V

Continuous Power Dissipation (T_A = +25°C) ⁽²⁾

..... 2.6W
 Junction Temperature 150°C
 Lead Temperature 260°C
 Storage Temperature -65°C to +150°C

Recommended Operating Conditions ⁽³⁾

Supply Voltage V_{IN} V_{CC} 3V to 6V
 Operating Junct. Temp (T_J) -40°C to +125°C

Thermal Resistance ⁽⁴⁾ θ_{JA} θ_{JC}

3x4 QFN14 48 11 °C/W

Notes:

- Exceeding these ratings may damage the device.
- The maximum allowable power dissipation is a function of the maximum junction temperature T_{J(MAX)}, the junction-to-ambient thermal resistance θ_{JA}, and the ambient temperature T_A. The maximum allowable continuous power dissipation at any ambient temperature is calculated by P_{D(MAX)} = (T_{J(MAX)}-T_A)/θ_{JA}. Exceeding the maximum allowable power dissipation will cause excessive die temperature, and the regulator will go into thermal shutdown. Internal thermal shutdown circuitry protects the device from permanent damage.
- The device is not guaranteed to function outside of its operating conditions.
- Measured on JESD51-7, 4-layer PCB.

ELECTRICAL CHARACTERISTICS

$V_{IN} = 5V$, $V_{CC} = 5V$, $T_A = +25^{\circ}C$, unless otherwise noted.

Parameters	Symbol	Condition	Min	Typ	Max	Units
Feedback Voltage	V_{FB}	$3V \leq V_{IN} \leq 6V$	0.788	0.808	0.828	V
Feedback Current	I_{FB}	$V_{FB} = 0.8V$		10		nA
Switch On Resistance	$R_{DS(ON)}$			45		m Ω
Switch Leakage		$V_{EN} = 0V$, $V_{SW} = 0V$		0	10	μA
Current Limit ⁵⁾			8			A
Oscillator Frequency	f_{SW}	$V_{FB} = 0.6V$	400	600	800	KHz
Fold-back Frequency		$V_{FB} = 0V$	60	150	240	KHz
Maximum Duty Cycle		$V_{FB} = 0.6V$	85	90		%
Minimum On Time	t_{ON}			100		ns
V_{CC} Under Voltage Lockout Threshold Rising				2.8		V
V_{CC} Under Voltage Lockout Threshold Hysteresis				200		mV
EN Input Low Voltage					0.4	V
En Input High Voltage			2.0			V
EN Input Current		$V_{EN} = 2V$		2		μA
		$V_{EN} = 0V$		0.1		
Sync Frequency Range (Low)	F_{SYNCL}			300		KHz
Sync Frequency Range (High)	F_{SYNCH}			1.5		MHz
Enable Turnoff Delay	T_{OFF}			5.0		us
Supply Current (Shutdown)		$V_{EN} = 0V$, $V_{CC} = 5V$		45	65	μA
Supply Current (Quiescent)		$V_{EN} = 2V$, $V_{FB} = 1V$		0.75	1.0	mA
Thermal Shutdown				150		$^{\circ}C$
Gate Driver Sink Impedance	R_{SINK}			1		Ω
Gate Driver Source Impedance	R_{SOURCE}			4		Ω
Gate Drive Current Sense Trip Threshold				20		mV
Power Good Threshold Rising			0.69	0.74	0.79	V
Power Good Threshold Hysteresis				40		mV
PG Pin Level	V_{PG}	PG Sink 4mA			0.4	V

Note:

5) Guaranteed by design.

TYPICAL PERFORMANCE CHARACTERISTICS

$V_{IN}=5V$, $V_{CC}=5V$, $V_{OUT}=2.5V$, $T_A = +25^{\circ}C$, unless otherwise noted.

Efficiency vs. Output Current

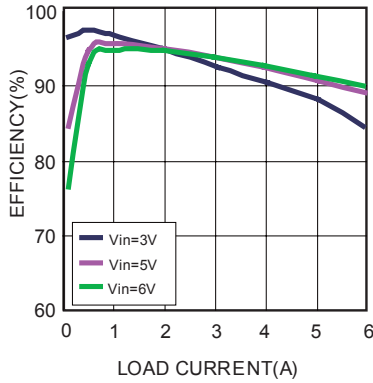

Enabled Supply Current vs. Vcc Voltage

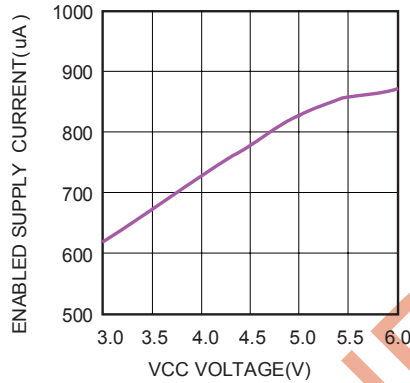

Disabled Supply Current vs. Vcc Voltage

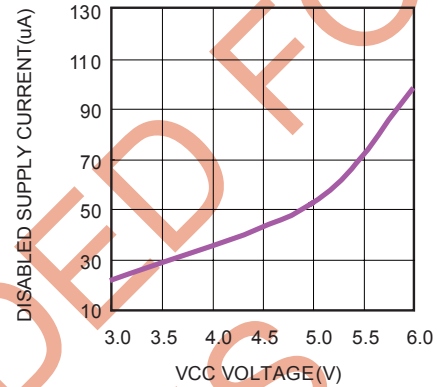

Case Temperature Rise vs. Output Current

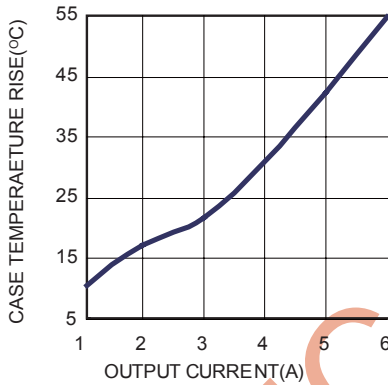

Peak Current vs. Duty Cycle

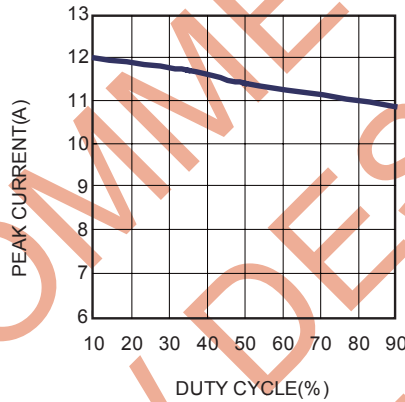

Line Regulation

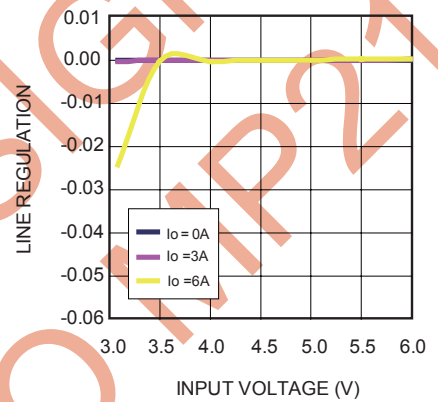

Load Regulation

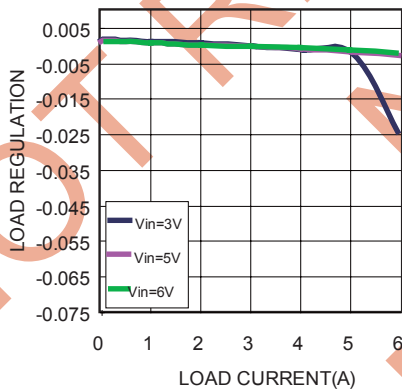

TYPICAL PERFORMANCE CHARACTERISTICS (continued)

$V_{IN}=6V$, $V_{CC}=5V$, $V_{OUT}=2.5V$, $T_A = +25^{\circ}C$, unless otherwise noted.

Hiccup with Short Output

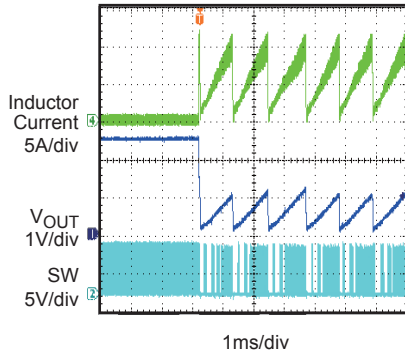

Short Recovery

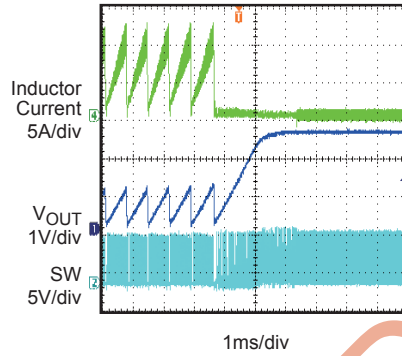

Enable Startup
No Load

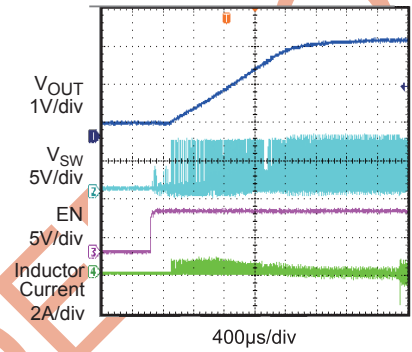

Enable Startup
Full Load

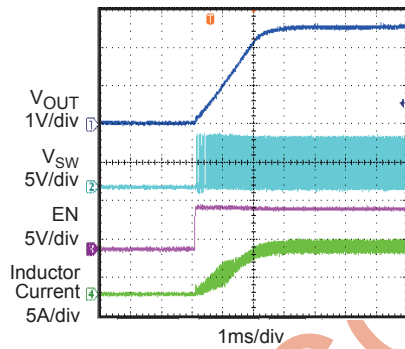

Vcc Startup
No Load

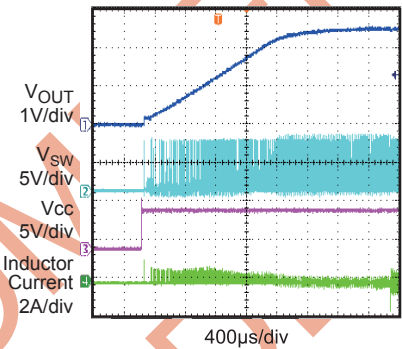

Vcc Startup
Full Load

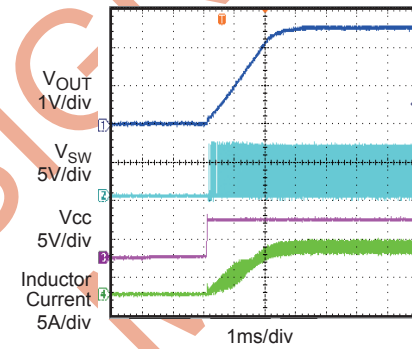

Input Ripple Voltage
Full Load

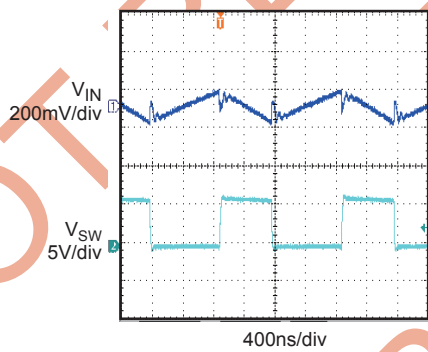

Output Ripple Voltage
Full Load

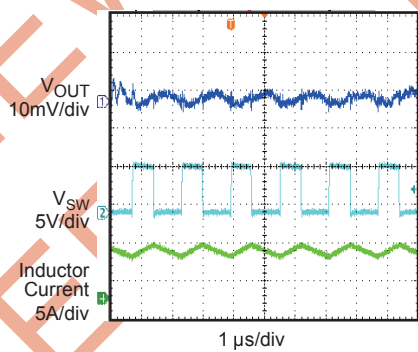

Load Transient Response
Load:3A-6A with slew rate:1A/us

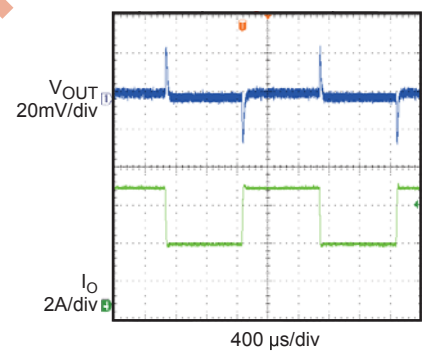

PIN FUNCTIONS

Pin #	Name	Description
1	FB	Feedback. An external resistor divider from the output to GND, tapped to the FB pin sets the output voltage. To prevent current limit run away during a short circuit fault condition the frequency foldback comparator lowers the oscillator frequency when the FB voltage is below 250mV.
2	PG	Power Good Indicator. Connect this pin to V_{CC} or V_{OUT} by a 100k Ω pull-up resistor. The output of this pin is low if the output voltage is 10% less than the nominal voltage, otherwise it is an open drain.
3	EN/SYNC	On/Off Control and External Frequency Synchronization Input.
4, 5, 6	IN	Supply Voltage. The MP8352 operates from a +3V to +6V unregulated input. C1 is needed to prevent large voltage spikes from appearing at the input.
7	N/C	No Connect.
8, 9, 10	SW	Switch Output.
11	BST	Bootstrap. This capacitor is needed to drive the power switch's gate above the supply voltage. It is connected between SW and BST pins to form a floating supply across the power switch driver.
12	VCC	Need external Bias Power Supply. Decouple with a 1 μ F ceramic capacitor.
13	BG	Gate Driver Output. Connect this pin to the synchronous MOSFET Gate.
14	GND, Exposed Pad	Ground. This pin is the voltage reference for the regulated output voltage. For this reason care must be taken in its layout. This node should be placed outside of the M2 to C1 ground path to prevent switching current spikes from inducing voltage noise into the part. Connect exposed pad to GND plane for optimal thermal performance.

OPERATION

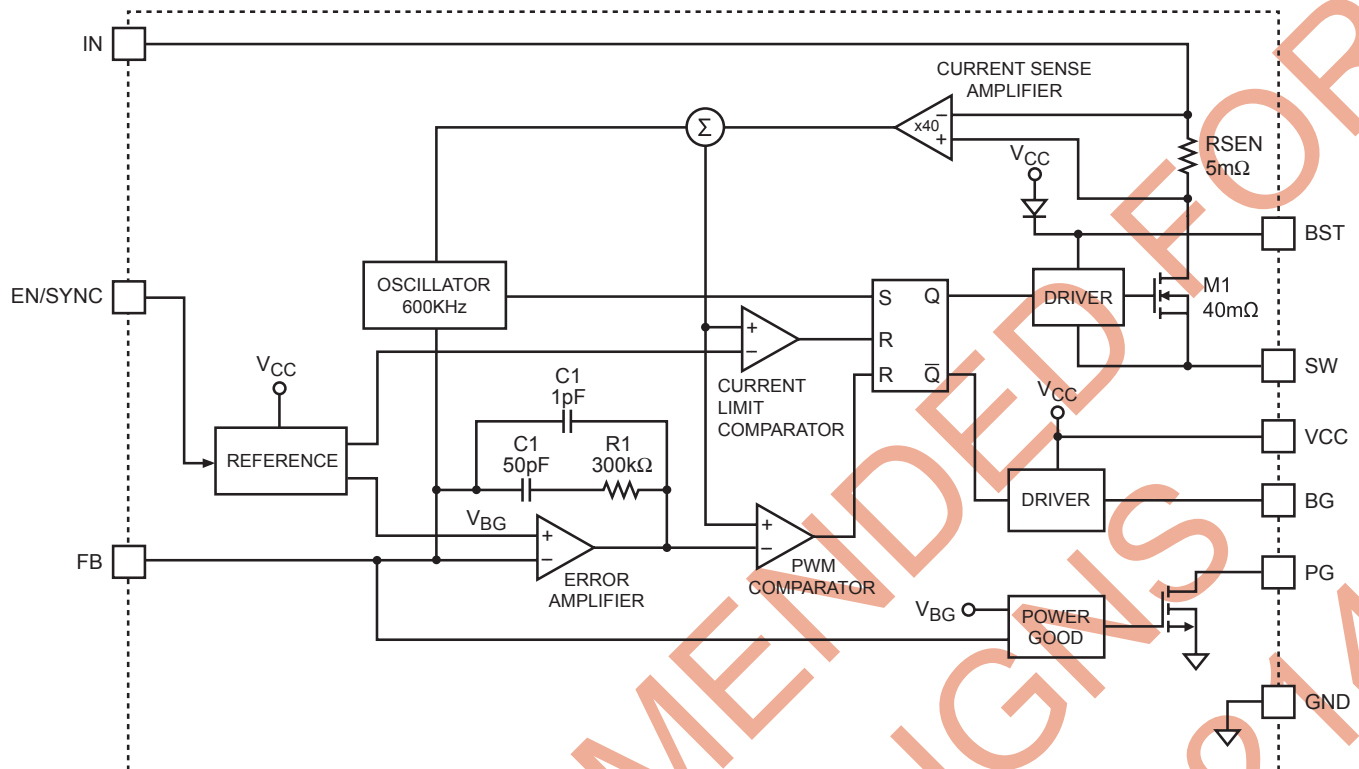

Figure 1—Functional Block Diagram

The MP8352 is a fixed frequency, synchronous, step-down switching regulator with an integrated high-side power MOSFET and a gate driver for a low-side external MOSFET. It achieves 6A continuous output current over a wide input supply range with excellent load and line regulation. It provides a single highly efficient solution with current mode control for fast loop response and easy compensation.

The MP8352 operates in a fixed frequency, peak current control mode to regulate the output voltage. A PWM cycle is initiated by the internal clock. The integrated high-side power MOSFET is turned on and remains on until its current reaches the value set by the COMP voltage. When the power switch is off, it remains off until the next clock cycle starts. If, in 90% of one PWM period, the current in the power MOSFET does not reach the COMP set current value, the power MOSFET will be forced to turn off.

Error Amplifier

The error amplifier compares the FB pin voltage with the internal 0.8V reference (REF) and outputs a current proportional to the difference between the two. This output current is then used to charge or discharge the internal compensation network to form the COMP voltage, which is used to control the power MOSFET current. The optimized internal compensation network minimizes the external component counts and simplifies the control loop design.

Enable/Synch Control

The MP8352 has a dedicated Enable/Synch control pin (EN/SYNC). By pulling it high or low, the IC can be enabled and disabled by EN. Tie EN to VIN for automatic start up. To disable the part, EN must be pulled low for at least 5 μ s.

The MP8352 can be synchronized to external clock range from 300KHz up to 1.5MHz through the EN/SYNC pin. The internal clock rising edge is synchronized to the external clock rising edge.

VCC Under-Voltage Lockout (UVLO)

Under-voltage lockout (UVLO) is implemented to protect the chip from operating at insufficient supply voltage. The MP8352 UVLO comparator monitors the external power supply, VCC. The UVLO rising threshold is about 2.8V while its falling threshold is a consistent 2.6V. If VIN is less than 5V, Vcc should be kept above 5V to guarantee the normal operation.

Internal Soft-Start

The soft-start is implemented to prevent the converter output voltage from overshooting during startup. When the chip starts, the internal circuitry generates a soft-start voltage (SS) ramping up from 0V to 1.2V. When it is lower than the internal reference (REF), SS overrides REF so the error amplifier uses SS as the reference. When SS is higher than REF, REF regains control.

Over-Current-Protection and Hiccup

The MP8352 has cycle-by-cycle over current limit when the inductor current peak value exceeds the set current limit threshold. Meanwhile, output voltage starts to drop until FB is below the Under-Voltage (UV) threshold, typically 30% below the reference. Once a UV is triggered, the MP8352 enters hiccup mode to periodically restart the part. This protection mode is especially useful when the output is dead-short to ground. The average short circuit current is greatly reduced to alleviate the thermal issue and to protect the regulator. The MP8352 exits the hiccup mode once the over current condition is removed.

Thermal Shutdown

Thermal shutdown is implemented to prevent the chip from operating at exceedingly high temperatures. When the silicon die temperature is higher than 150°C, it shuts down the whole chip. When the temperature is lower than its lower threshold, typically 140°C, the chip is enabled again.

Floating Driver and Bootstrap Charging

The floating power MOSFET driver is powered by an external bootstrap capacitor. This floating driver has its own UVLO protection. This UVLO's rising threshold is 2.2V with a hysteresis of 150mV. The bootstrap capacitor voltage is regulated internally by VIN through D1, M3, C4, L1 and C2 (Figure 2). If (VIN-VSW) is more than 5V, U2 will regulate M1 to maintain a 5V BST voltage across C4.

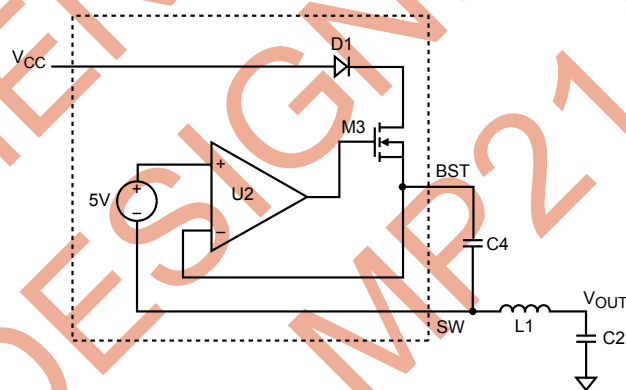

Figure 2—Internal Bootstrap Charging Circuit

Startup and Shutdown

If VIN, VCC and EN are higher than their appropriate thresholds, the chip starts. The reference block starts first, generating stable reference voltage and currents, and then the internal regulator is enabled. The regulator provides stable supply for the remaining circuitries.

Three events can shut down the chip: EN low, VCC low and thermal shutdown. In the shutdown procedure, the signaling path is first blocked to avoid any fault triggering. The COMP voltage and the internal supply rail are then pulled down. The floating driver is not subject to this shutdown command.

APPLICATION INFORMATION

Setting the Output Voltage

The external resistor divider is used to set the output voltage (see the schematic on front page). The feedback resistor R1 also sets the feedback loop bandwidth with the internal compensation capacitor (see Figure 1). Choose R1 to be around 40.2kΩ for optimal transient response. R2 is then given by:

$$R2 = \frac{R1}{\frac{V_{OUT}}{0.8V} - 1}$$

Table 1—Resistor Selection for Common Output Voltages

V _{OUT} (V)	R1 (kΩ)	R2 (kΩ)
1.8	40.2 (1%)	32.4 (1%)
2.5	40.2 (1%)	19.1 (1%)
3.3	40.2 (1%)	13 (1%)

Selecting the Inductor

A 1μH to 10μH inductor with a DC current rating of at least 25% percent higher than the maximum load current is recommended for most applications. For highest efficiency, the inductor DC resistance should be less than 15mΩ. For most designs, the inductance value can be derived from the following equation.

$$L = \frac{V_{OUT} \times (V_{IN} - V_{OUT})}{V_{IN} \times \Delta I_L \times f_{OSC}}$$

Where ΔI_L is the inductor ripple current.

Choose inductor current to be approximately 30% if the maximum load current, 6A. The maximum inductor peak current is:

$$I_{L(MAX)} = I_{LOAD} + \frac{\Delta I_L}{2}$$

Under light load conditions below 100mA, larger inductance is recommended for improved efficiency.

Synchronous MOSFET

The external synchronous MOSFET is used to supply current to the inductor when the internal high-side switch is off. It reduces the power loss significantly when compared against a Schottky rectifier.

Table 2 lists example synchronous MOSFETs and manufacturers.

Table 2—Synchronous MOSFET Selection Guide

Part No.	Manufacture
AM4874	Analog Power
Si7848	Vishay

Selecting the Input Capacitor

The input current to the step-down converter is discontinuous, therefore a capacitor is required to supply the AC current to the step-down converter while maintaining the DC input voltage. Use low ESR capacitors for the best performance. Ceramic capacitors with X5R or X7R dielectrics are highly recommended because of their low ESR and small temperature coefficients. For most applications, a 22μF capacitor is sufficient.

Since the input capacitor (C1) absorbs the input switching current it requires an adequate ripple current rating. The RMS current in the input capacitor can be estimated by:

$$I_{C1} = I_{LOAD} \times \sqrt{\frac{V_{OUT}}{V_{IN}} \times \left(1 - \frac{V_{OUT}}{V_{IN}}\right)}$$

The worse case condition occurs at V_{IN} = 2V_{OUT}, where:

$$I_{C1} = \frac{I_{LOAD}}{2}$$

For simplification, choose the input capacitor whose RMS current rating greater than half of the maximum load current.

The input capacitor can be electrolytic, tantalum or ceramic. When using electrolytic or tantalum capacitors, a small, high quality ceramic capacitor, i.e. 0.1µF, should be placed as close to the IC as possible. When using ceramic capacitors, make sure that they have enough capacitance to provide sufficient charge to prevent excessive voltage ripple at input. The input voltage ripple caused by capacitance can be estimated by:

$$\Delta V_{IN} = \frac{I_{LOAD}}{f_s \times C1} \times \frac{V_{OUT}}{V_{IN}} \times \left(1 - \frac{V_{OUT}}{V_{IN}}\right)$$

Selecting the Output Capacitor

The output capacitor (C2) is required to maintain the DC output voltage. Ceramic, tantalum, or low ESR electrolytic capacitors are recommended. Low ESR capacitors are preferred to keep the output voltage ripple low. The output voltage ripple can be estimated by:

$$\Delta V_{OUT} = \frac{V_{OUT}}{f_s \times L} \times \left(1 - \frac{V_{OUT}}{V_{IN}}\right) \times \left(R_{ESR} + \frac{1}{8 \times f_s \times C2}\right)$$

Where L is the inductor value and R_{ESR} is the equivalent series resistance (ESR) value of the output capacitor.

In the case of ceramic capacitors, the impedance at the switching frequency is dominated by the capacitance. The output voltage ripple is mainly caused by the capacitance. For simplification, the output voltage ripple can be estimated by:

$$\Delta V_{OUT} = \frac{V_{OUT}}{8 \times f_s^2 \times L \times C2} \times \left(1 - \frac{V_{OUT}}{V_{IN}}\right)$$

In the case of tantalum or electrolytic capacitors, the ESR dominates the impedance at the switching frequency. For simplification, the output ripple can be approximated to:

$$\Delta V_{OUT} = \frac{V_{OUT}}{f_s \times L} \times \left(1 - \frac{V_{OUT}}{V_{IN}}\right) \times R_{ESR}$$

The characteristics of the output capacitor also affect the stability of the regulation system. The MP8352 can be optimized for a wide range of capacitance and ESR values.

PCB Layout Guide

PCB layout is very important to achieve stable operation. It is highly recommended to duplicate EVB layout for optimum performance.

If change is necessary, please follow these guidelines and take Figure 3 for references.

- 1) Keep the path of switching current short and minimize the loop area formed by Input cap, high-side MOSFET and low-side MOSFET/schottky diode (as the red dotted line loop shows).
- 2) Keep the connection of low-side MOSFET/schottky diode between SW pin and input power ground as short and wide as possible.
- 3) Bypass ceramic capacitors are suggested to be put close to the V_{IN} and V_{CC} Pin.
- 4) Ensure all feedback connections are short and direct. Place the feedback resistors and compensation components as close to the chip as possible.
- 5) Route SW away from sensitive analog areas such as FB.
- 6) Connect IN, SW, and especially GND respectively to a large copper area to cool the chip to improve thermal performance and long-term reliability.

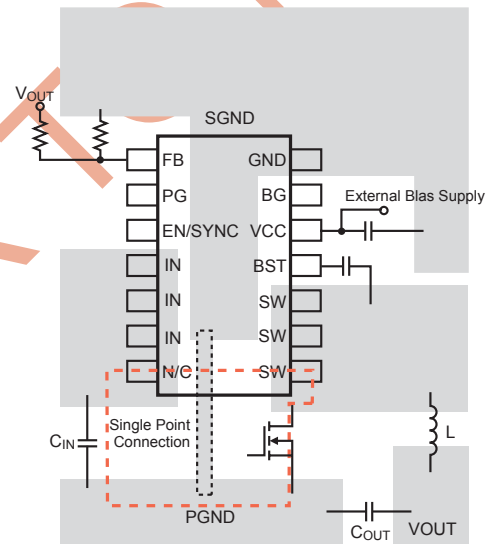

Figure 3—PCB Layout Conceptual Drawing, Only Top Layer Shown, and a Ground Plane Is Assumed

External Bootstrap Diode

An external bootstrap diode may enhance the efficiency of the regulator, the applicable conditions of external BST diode are:

- Duty cycle is high: $D = \frac{V_{OUT}}{V_{IN}} > 65\%$

In these cases, an external BST diode is recommended from V_{CC} to BST pin, as shown in Fig.4

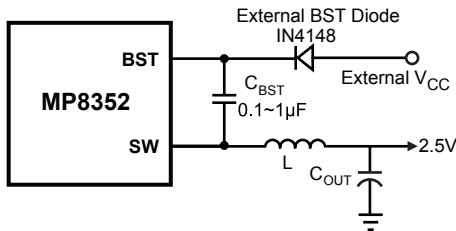

Figure 4—Add Optional External Bootstrap Diode to Enhance Efficiency

The recommended external BST diode is IN4148, and the BST cap is 0.1~1µF, when the BST diode is used.

Vcc Bias Supply Consideration

The MP8352 does not have the LDO inside. It needs external bias power supply to make the device work properly.

PACKAGE INFORMATION

3mm x 4mm QFN14

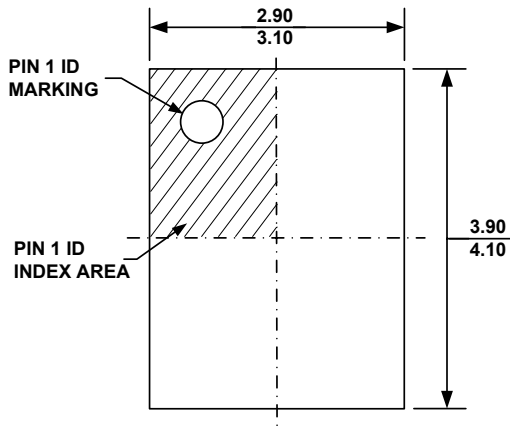

TOP VIEW

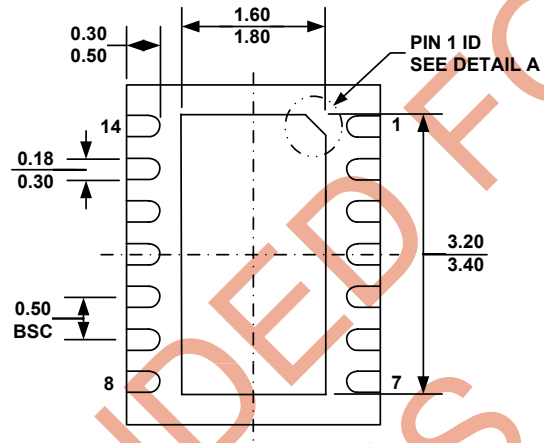

BOTTOM VIEW

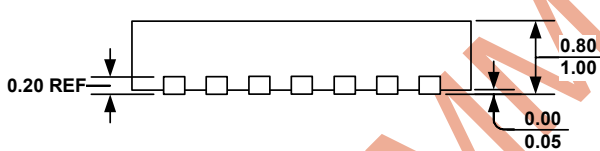

SIDE VIEW

PIN 1 ID OPTION A
0.30x45° TYP.

PIN 1 ID OPTION B
R0.20 TYP.



DETAIL A

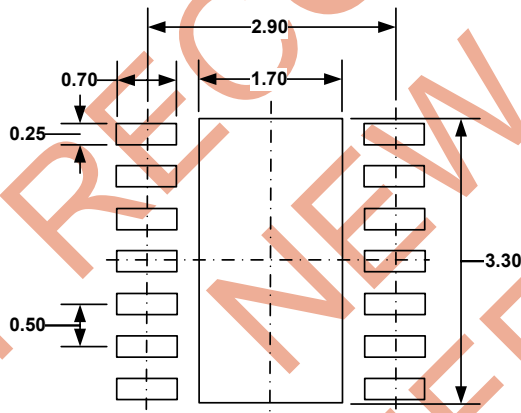

RECOMMENDED LAND PATTERN

NOTE:

- 1) ALL DIMENSIONS ARE IN MILLIMETERS.
- 2) EXPOSED PADDLE SIZE DOES NOT INCLUDE MOLD FLASH.
- 3) LEAD COPLANARITY SHALL BE 0.10 MILLIMETER MAX.
- 4) JEDEC REFERENCE IS MO-229, VARIATION VGED-3.
- 5) DRAWING IS NOT TO SCALE.

NOTICE: The information in this document is subject to change without notice. Users should warrant and guarantee that third party Intellectual Property rights are not infringed upon when integrating MPS products into any application. MPS will not assume any legal responsibility for any said applications.