



The Future of Analog IC Technology®

# MPQ4470/4470A

## High-Efficiency, Fast-Transient, 5A, 36V Synchronous, Step-Down Converter

### MPQ4470 with Latch-off OVP, and MPQ4470A without Latch-off OVP

## DESCRIPTION

The MPQ4470/4470A is a fully-integrated, high-frequency, synchronous, rectified, step-down, switch-mode converter. It offers a very compact solution to achieve a 5A, continuous-output current over a wide input-supply range with excellent load and line regulation. It also provides fast transient response and good stability for wide input-supply and load range. The MPQ4470/4470A operates at high efficiency over a wide output current load range.

MPQ4470 has full protection features include SCP, OCP, OVP latch, UVP, and thermal shutdown. MPQ4470A has the same protection features to MPQ4470 except has no OVP latch function.

The MPQ4470/4470A requires a minimal number of readily-available, standard, external components, and is available in a space-saving 3mm×4mm, 20-pin, QFN package.

## FEATURES

- Wide 4.5V-to-36V Operating Input Range
- Guaranteed 5A, Continuous Output Current
- Internal 40mΩ High-Side, 20mΩ Low-Side Power MOSFETs
- Proprietary Switching-Loss-Reduction Technology
- 1% Reference Voltage
- Programmable Soft-Start Time
- Low Drop-out Mode
- 100kHz-to-1MHz Switching Frequency
- SCP, OCP, OVP Latch (MPQ4470 only), UVP, and Thermal Shutdown
- Output Adjustable from 0.8V to  $0.9 \times V_{IN}$
- Available in a 3mm×4mm 20-pin QFN Package
- Available in AEC-Q100 Grade 1

## APPLICATIONS

- Notebook Systems and I/O Power
- Automotive Systems
- Networking Systems
- Industrial Supplies
- Optical Communications Systems
- Distributed Power and POL Systems

All MPS parts are lead-free, halogen-free, and adhere to the RoHS directive. For MPS green status, please visit the MPS website under Quality Assurance.

"MPS" and "The Future of Analog IC Technology" are registered trademarks of Monolithic Power Systems, Inc.

## TYPICAL APPLICATION

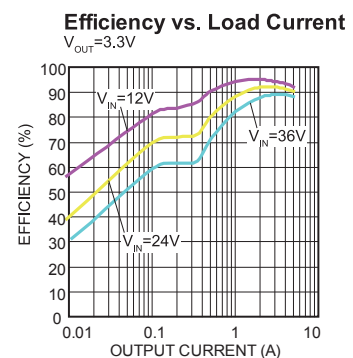
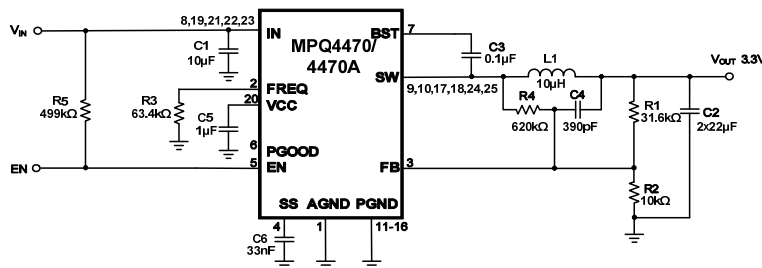

## ORDERING INFORMATION

Part Number*	Package	Top Marking
MPQ4470GL	QFN20 (3mm×4mm)	4470
MPQ4470AGL	QFN20 (3mm×4mm)	4470A
MPQ4470GL-AEC1	QFN20 (3mm×4mm)	4470
MPQ4470AGL-AEC1	QFN20 (3mm×4mm)	4470A

\* For Tape & Reel, add suffix -Z (e.g. MPQ4470/4470AGL-Z)

## PACKAGE REFERENCE

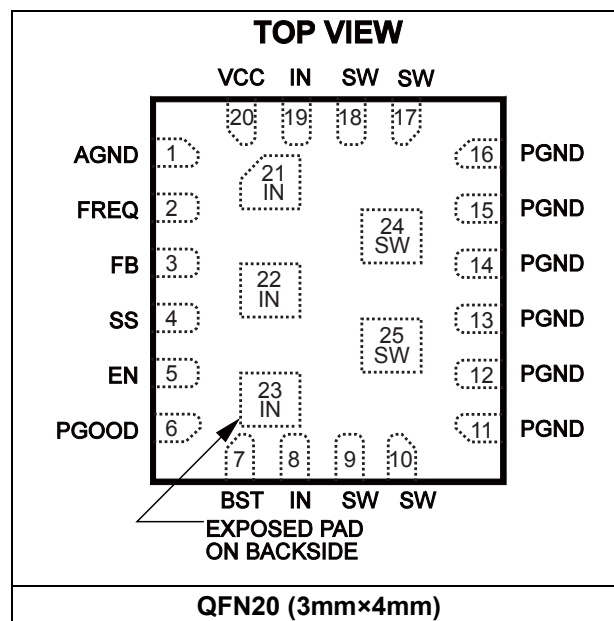

### ABSOLUTE MAXIMUM RATINGS <sup>(1)</sup>

Supply Voltage $V_{IN}$ .....	40V
$V_{SW}$ .....	-0.3V to $V_{IN} + 0.3V$
$V_{BST}$ .....	$V_{SW} + 6V$
$V_{PGOOD}$ .....	-0.3V to $V_{CC} + 0.6V$
All Other Pins .....	-0.3V to +6V
EN Sink Current .....	150 $\mu$ A
Continuous Power Dissipation ( $T_A = +25^\circ\text{C}$ ) <sup>(2)</sup> .....	2.6W
Operating Junction Temperature .....	150 $^\circ\text{C}$
Lead Temperature .....	260 $^\circ\text{C}$
Storage Temperature .....	-65 $^\circ\text{C}$ to +150 $^\circ\text{C}$

### Recommended Operating Conditions <sup>(3)</sup>

Supply Voltage $V_{IN}$ .....	4.5V to 36V
Output Voltage $V_{OUT}$ .....	0.8V to $0.9 \times V_{IN}$
Operating Junction Temp. ( $T_J$ ) .....	-40 $^\circ\text{C}$ to +125 $^\circ\text{C}$

<b>Thermal Resistance <sup>(4)</sup></b>	$\theta_{JA}$	$\theta_{JC}$
QFN20 (3mm×4mm) .....	48	10... $^\circ\text{C/W}$

#### Notes:

- Exceeding these ratings may damage the device.
- The maximum allowable power dissipation is a function of the maximum junction temperature  $T_J(\text{MAX})$ , the junction-to-ambient thermal resistance  $\theta_{JA}$ , and the ambient temperature  $T_A$ . The maximum allowable continuous power dissipation at any ambient temperature is calculated by  $P_D(\text{MAX}) = (T_J(\text{MAX}) - T_A) / \theta_{JA}$ . Exceeding the maximum allowable power dissipation will cause excessive die temperature, and the regulator will go into thermal shutdown. Internal thermal shutdown circuitry protects the device from permanent damage.
- The device is not guaranteed to function outside of its operating conditions.
- Measured on JESD51-7, 4-layer PCB.

## ELECTRICAL CHARACTERISTICS

$V_{IN} = 24V$ ,  $V_{EN} = 2V$ ,  $T_J = -40^{\circ}C$  to  $+125^{\circ}C$ , unless otherwise noted. Typical values are at  $T_J = 25^{\circ}C$ .

Parameters	Symbol	Condition	Min	Typ	Max	Units
Supply Current (Shutdown)	$I_{IN}$	$V_{EN} = 0V$		10	300	nA
Supply Current (Quiescent)	$I_{IN}$	$V_{FB} = 0.95V$		500	600	$\mu A$
HS Switch On Resistance	$HS_{RDS-ON}$			40	65	m $\Omega$
LS Switch On Resistance <sup>(5)</sup>	$LS_{RDS-ON}$			20		m $\Omega$
Switch Leakage	$SW_{LKG}$	$V_{EN} = 0V$ $V_{SW} = 0V$ or $36V$		10	400	nA
Current Limit	$I_{LIMIT}$		6	8	12	A
One-Shot On Time	$t_{ON}$	$V_{IN}=12V$ , $R_{FREQ}=30k\Omega$	230	280	330	ns
Minimum Off Time <sup>(5)</sup>	$t_{OFF}$			100		ns
Fold-back Off Time <sup>(5)</sup>	$t_{FB}$	$I_{LIM}=1(HIGH)$ , $FB>50\%V_{REF}$		4.8		$\mu s$
Fold-back Off Time <sup>(5)</sup>	$t_{FB}$	$I_{LIM}=1(HIGH)$ , $FB<50\%V_{REF}$		16.8		$\mu s$
OCP hold-off time <sup>(5)</sup>	$t_{OC}$	$I_{LIM}=1(HIGH)$		100		$\mu s$
Feedback Voltage	$V_{FB}$	$T_J = 25^{\circ}C$	807	815	823	mV
	$V_{FB}$	$T_J = -40^{\circ}C$ to $125^{\circ}C$	803		827	mV
Feedback Current	$I_{FB}$	$V_{FB} = 815mV$		10	50	nA
Soft Start Charging Current	$I_{SS}$	$V_{SS}=0V$	6	8.5	11	$\mu A$
Power Good Rising Threshold	$PGOOD_{Vth-Hi}$		0.87	0.9	0.93	$V_{FB}$
Power Good Falling Threshold	$PGOOD_{Vth-Lo}$		0.82	0.85	0.88	$V_{FB}$
Power Good Threshold Hysteresis	$PGOOD_{Vth-Hys}$			0.05		$V_{FB}$
Power Good Rising Delay	$t_{PGOOD}$		500	700	900	$\mu s$
EN Rising Threshold	$EN_{Vth-Hi}$		1.1	1.25	1.4	V
EN Falling Threshold	$EN_{Vth-Lo}$		0.73	0.86	0.99	V
EN Threshold Hysteresis	$EN_{Vth-Hys}$			390		mV
EN Input Current	$I_{EN}$	$V_{EN} = 2V$		1.5	2	$\mu A$
$V_{IN}$ Under-Voltage Lockout Threshold Rising	$INUV_{Vth\_R}$		3.7	4.0	4.3	V
$V_{IN}$ Under-Voltage Lockout Threshold Falling	$INUV_{Vth\_F}$		2.8	3.1	3.4	V
$V_{IN}$ Under-Voltage Lockout Threshold Hysteresis	$INUV_{HYS}$			900		mV
$V_{CC}$ Regulator	$V_{CC}$	$I_{CC}=0$	4.5	4.85	5.2	V
$V_{CC}$ Load Regulation		$I_{CC}=10mA$		1	2	%
$V_o$ Over-Voltage Protection Threshold <sup>(6)</sup>	$V_{OVP}$		1.15	1.25	1.35	$V_{FB}$
Thermal Shutdown <sup>(5)</sup>	$T_{SD}$			175		$^{\circ}C$
Thermal Shutdown Hysteresis <sup>(5)</sup>	$T_{SD-HYS}$			45		$^{\circ}C$

**Note:**

5) Derived from bench characterization, not tested in production.

6) For MPQ4470 only, MPQ4470A has no OVP function.

## TYPICAL CHARACTERISTICS

**Feedback Voltage vs. Junction Temperature**  
VIN=24V

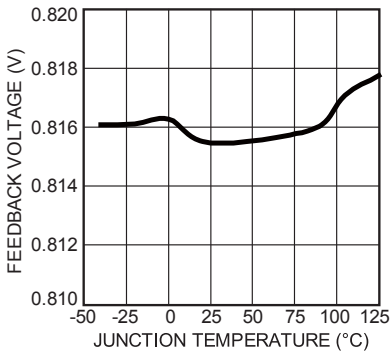

**Quiescent Current vs. Junction Temperature**  
VIN=24V

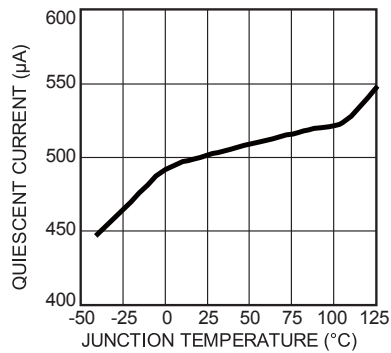

**Shutdown Current vs. Junction Temperature**  
VIN=24V

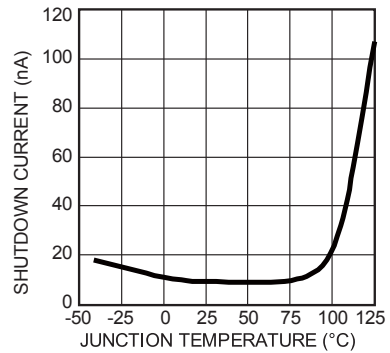

**Ton vs. Junction Temperature**  
VIN=12V

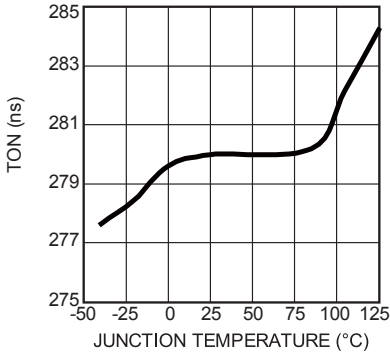

**HS R<sub>DS-ON</sub> vs. Junction Temperature**  
VIN=24V, BST-SW=5V

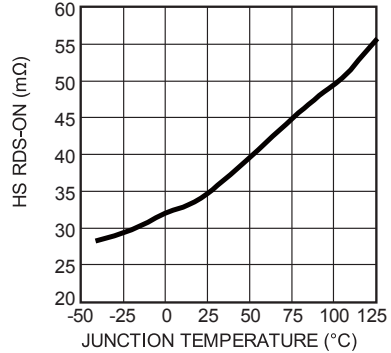

**Current Limit vs. Junction Temperature**  
VIN=24V

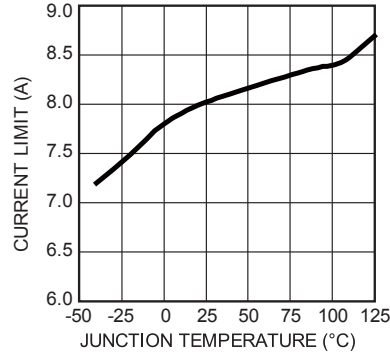

**I<sub>SS</sub> vs. Junction Temperature**  
VIN=24V

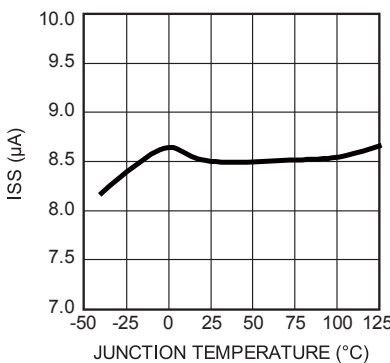

**VIN UVLO Rising Threshold vs. Junction Temperature**

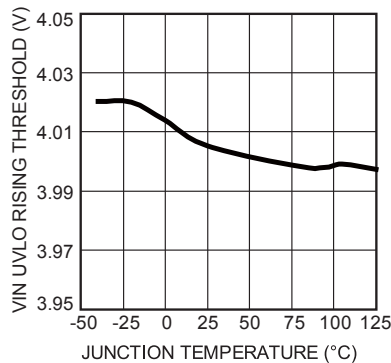

**VIN UVLO Falling Threshold vs. Junction Temperature**  
VIN=24V

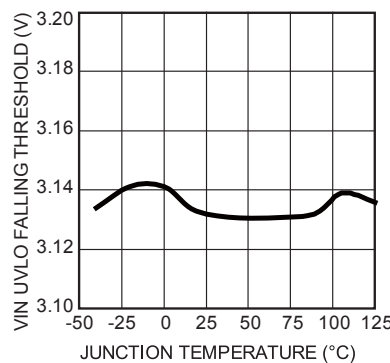

## TYPICAL CHARACTERISTICS

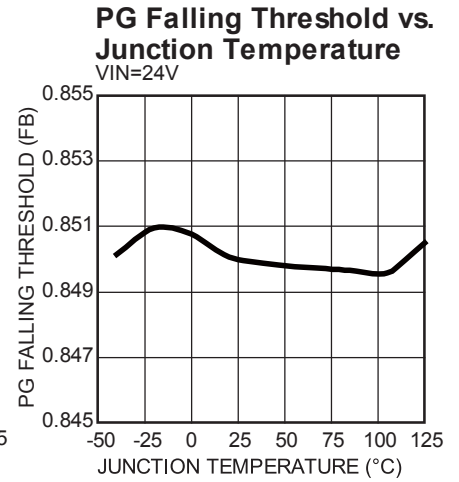
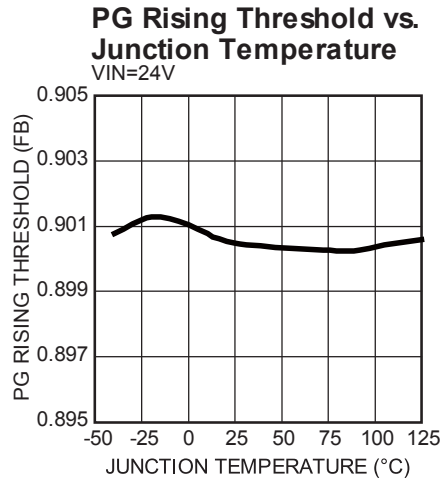
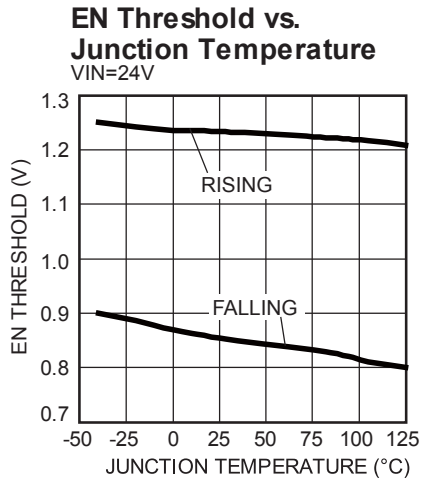

## TYPICAL PERFORMANCE CHARACTERISTICS

$V_{IN} = 24V$ ,  $V_{OUT} = 3.3V$ ,  $L = 10\mu H$ ,  $R_{FREQ} = 63.4k$ ,  $T_A = +25^\circ C$ , unless otherwise noted.

**Efficiency vs. Load Current**

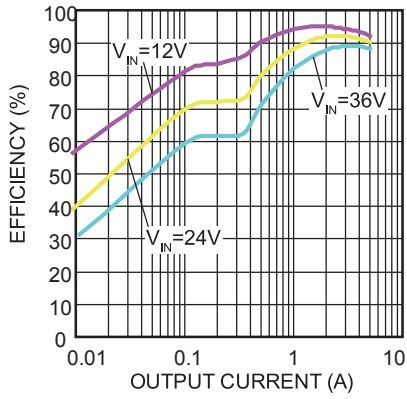

**Fsw vs. VIN**

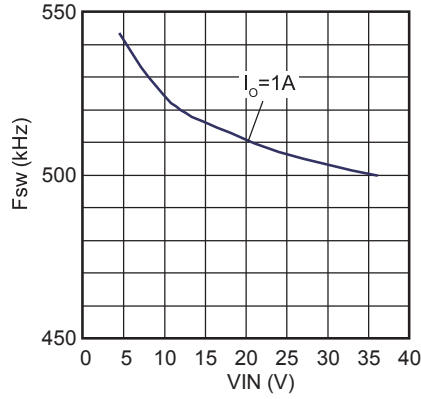

**Fsw vs. Output Current**

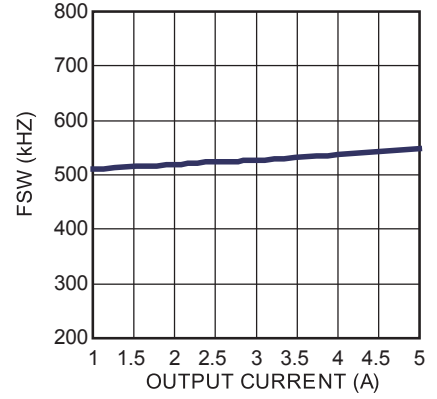

**Case Temperature Rise vs. Output Current**

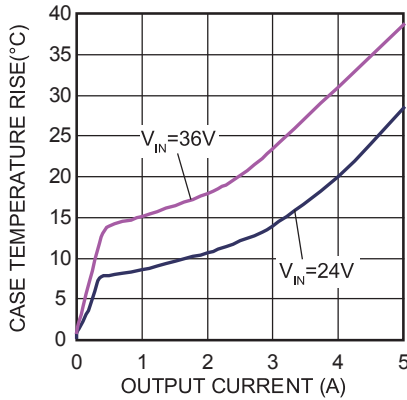

**Line Regulation**

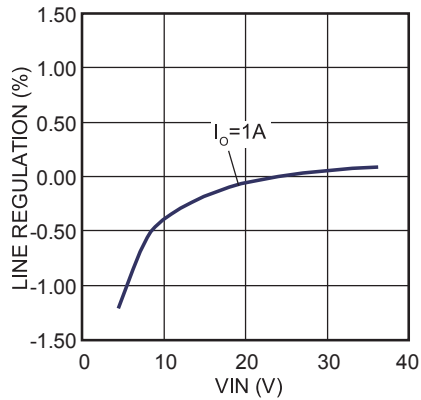

**Load Regulation**

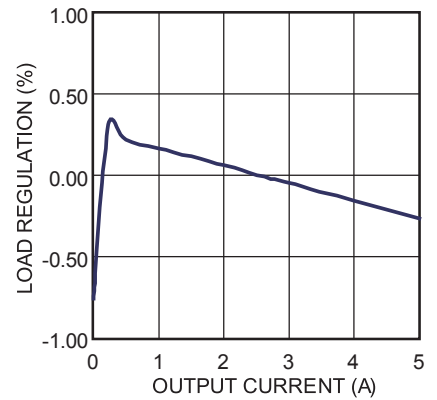

## TYPICAL PERFORMANCE CHARACTERISTICS (CONTINUED)

$V_{IN} = 24V$ ,  $V_{OUT} = 3.3V$ ,  $L = 10\mu H$ ,  $R_{FREQ} = 63.4k$ ,  $T_A = +25^\circ C$ , unless otherwise noted.

**Output Voltage Ripple**

$I_O = 0A$

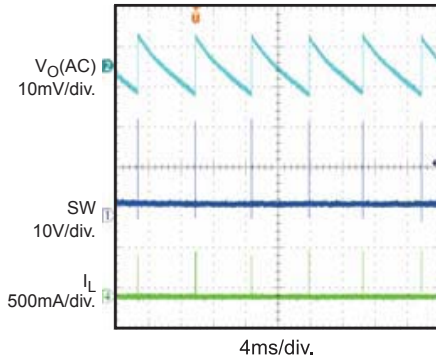

**Output Voltage Ripple**

$I_O = 5A$

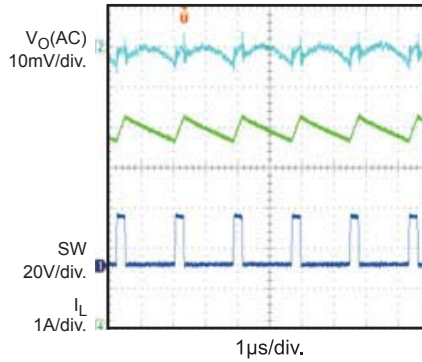

**Start-up Through VIN**

$I_O = 0A$

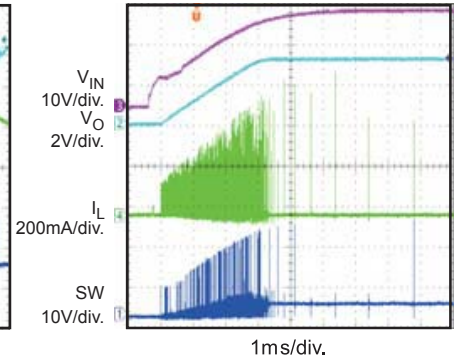

**Start-up Through VIN**

$I_O = 5A$

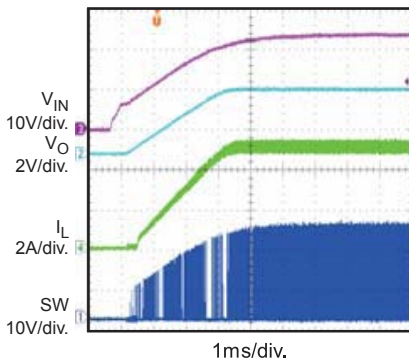

**Shutdown Through VIN**

$I_O = 0A$

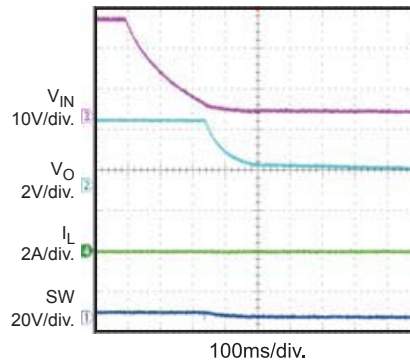

**Shutdown Through VIN**

$I_O = 5A$

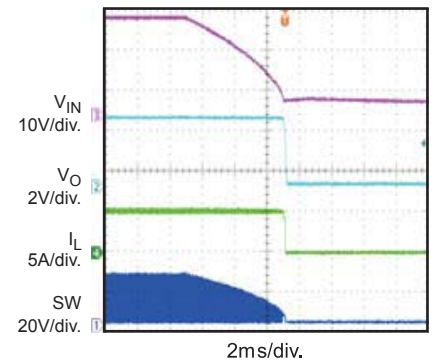

**Start-up Through EN**

$I_O = 0A$

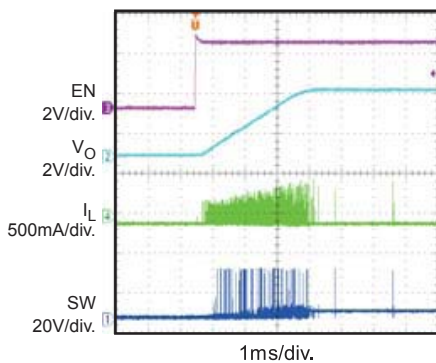

**Start-up Through EN**

$I_O = 5A$

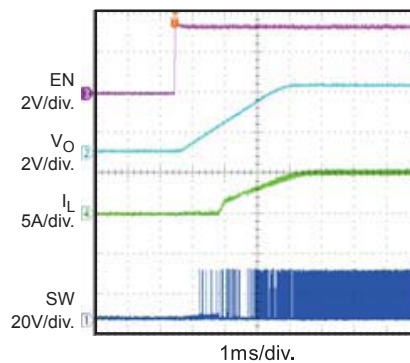

**Shutdown Through EN**

$I_O = 0A$

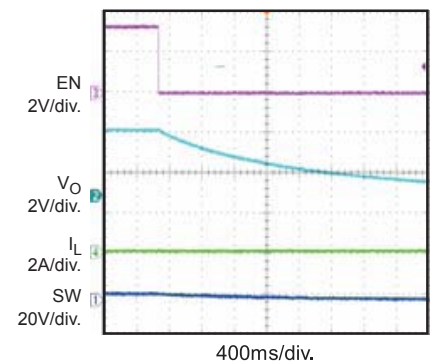



## TYPICAL PERFORMANCE CHARACTERISTICS (CONTINUED)

$V_{IN} = 24V$ ,  $V_{OUT} = 3.3V$ ,  $L = 10\mu H$ ,  $R_{FREQ} = 63.4k$ ,  $T_A = +25^\circ C$ , unless otherwise noted.

**Shutdown Through EN**

$I_O = 5A$

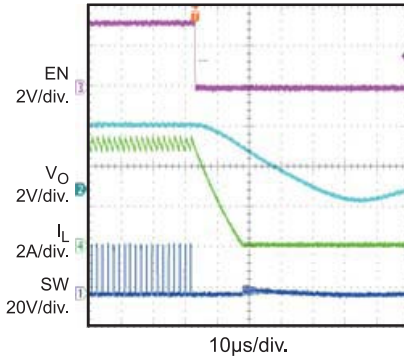

**Short Circuit Entry**

$I_O = 0A$

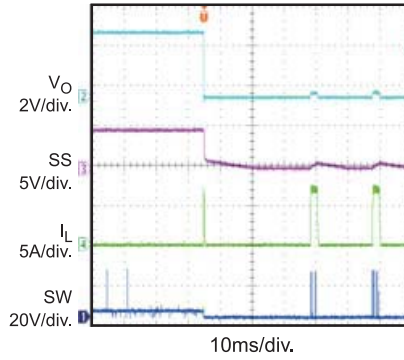

**Short Circuit Entry**

$I_O = 5A$

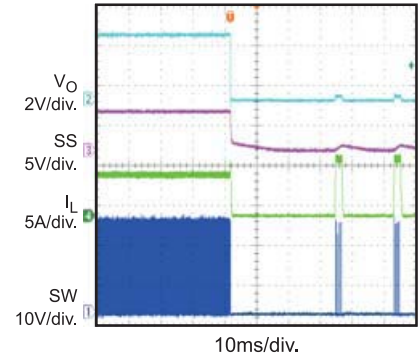

**Short Circuit Steady State**

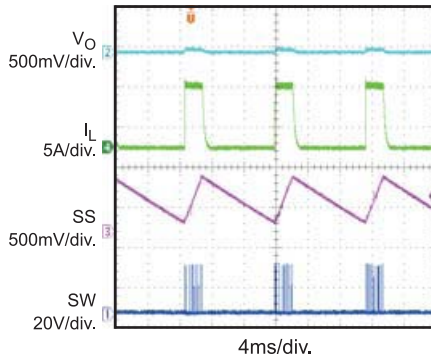

**Load Transient**

$I_O = 2.5A-5A@1.6A/\mu s$

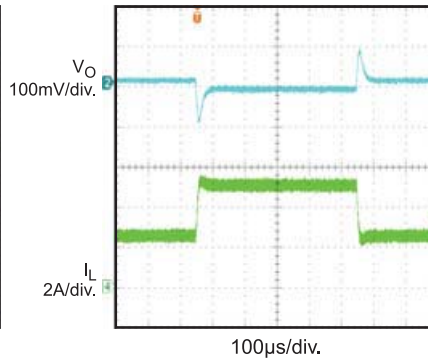

**Short Circuit Recovery**

$I_O = 0A$

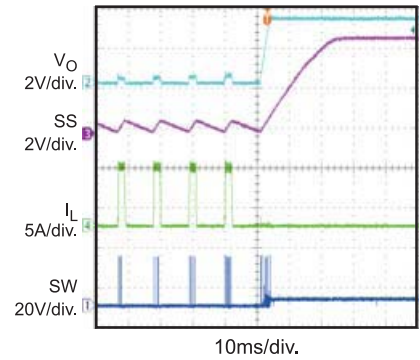

**Short Circuit Recovery**

$I_O = 5A$

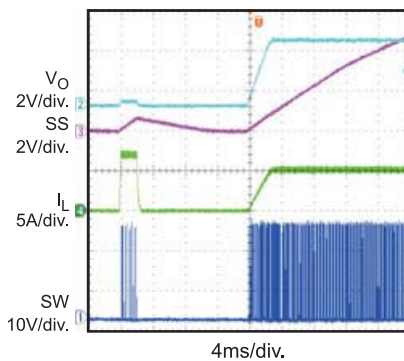

**Power Good Through EN Start-up**

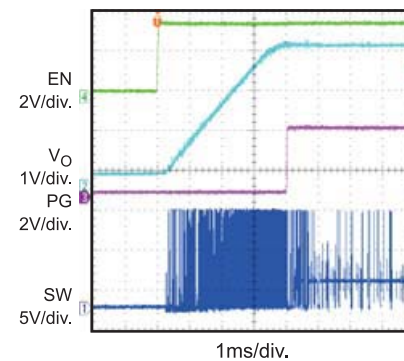

**Power Good Through EN Shutdown**

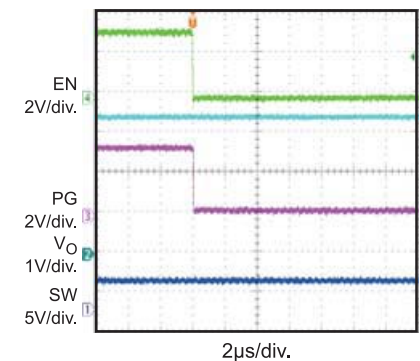



## PIN FUNCTIONS

Pin #	Name	Description
1	AGND	Analog Ground.
2	FREQ	Frequency Set (for CCM). The input voltage and the frequency-set resistor connected to GND determine the ON period.
3	FB	Feedback. The tap of external resistor divider from the output to GND sets the output voltage.
4	SS	Soft-Start. Connect an external capacitor to program the soft-start time for the switch-mode regulator. When the EN pin goes HIGH, an internal current source (8.5 $\mu$ A) charges up the capacitor and the SS voltage slowly and smoothly ramps up from 0 to $V_{FB}$ . When the EN pin goes LOW, the internal current source discharges the capacitor and the SS voltage slowly ramps down.
5	EN	Enable. EN=1 to enable the MPQ4470/4470A. For automatic start-up, connect EN pin to IN with a high ohm resistor. It includes an internal 1M $\Omega$ pull-down resistor.
6	PGOOD	Power Good Output. The output of this pin is an open drain and goes HIGH if the output voltage exceeds 90% of the nominal voltage. There is delay of $\sim$ 700 $\mu$ s from $FB \geq 90\%$ to PGOOD HIGH.
7	BST	Bootstrap. Requires a 0.1 $\mu$ F-to-1 $\mu$ F capacitor connected between SW and BS pins to form a floating supply across the high-side switch driver.
8, 19, Exposed pads 21, 22, 23	IN	Supply Voltage. The MPQ4470/4470A operates from a 4.5V-to-36V input rail. Requires $C_{IN}$ to decouple the input rail. Connect using wide PCB traces and multiple vias.
9, 10, 17, 18, Exposed pads 24, 25	SW	Switch Output. Connect using wide PCB traces and multiple vias.
11-16	PGND	System Ground. This pin is the reference ground of the regulated output voltage. For this reason care must be taken in PCB layout.
20	VCC	Internal Bias Supply. Decouple with a 1 $\mu$ F capacitor as close to the pin as possible.

## BLOCK DIAGRAM

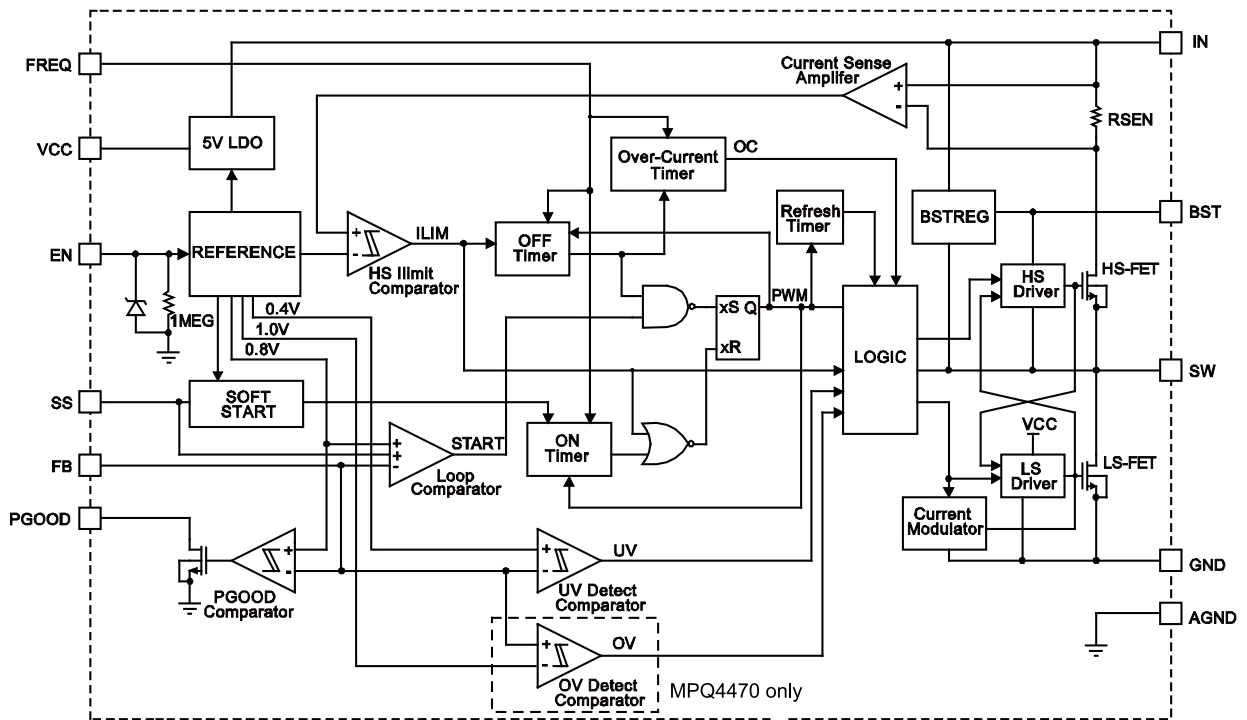

Figure 1—Functional Block Diagram

## OPERATION

### PWM Operation

The MPQ4470/4470A is a fully-integrated, synchronous, rectified, step-down, switch-mode converter. At the beginning of each cycle, the high-side MOSFET (HS-FET) turns ON when the feedback voltage ( $V_{FB}$ ) drops below the reference voltage ( $V_{REF}$ ), which indicates an insufficient output voltage. The ON period is determined by the input voltage and the frequency-set resistor as:

$$t_{ON}(\text{ns}) = \frac{96 \times R_{FREQ}(\text{k}\Omega)}{V_{IN}} + t_{DELAY}(\text{ns}) \quad (1)$$

After the ON period elapses, the HS-FET turns OFF. It is turned ON again when  $V_{FB}$  drops below  $V_{REF}$ . By repeating this operation, the converter regulates the output voltage. The integrated low-side MOSFET (LS-FET) turns ON when the HS-FET is OFF to minimize conduction loss. A dead short occurs between input and GND if both the HS-FET and the LS-FET turn on at the same time (shoot-through). An internal dead-time (DT) generated between HS-FET OFF and LS-FET ON, or LS-FET OFF and HS-FET ON prevents shoot-through.

### Heavy-Load Operation

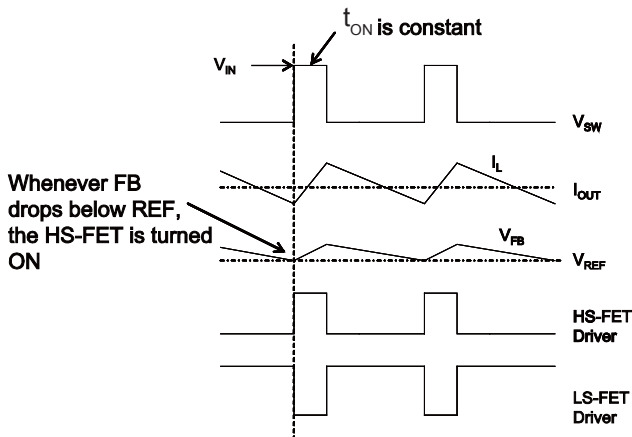

Figure 2: Heavy-Load Operation

In continuous-conduction mode (CCM), when the output current is HIGH, the HS-FET and LS-FET repeatedly turn ON/OFF as shown in MPS. All Rights Reserved. The inductor current never goes to zero. In CCM, the switching frequency ( $f_{sw}$ ) is fairly constant.

### Light-Load Operation

At light-load or no-load conditions, the output drops very slowly and the MPQ4470/4470A reduces the switching frequency automatically to maintain high efficiency. Figure 3 shows the light-load operation.  $V_{FB}$  does not reach  $V_{REF}$  as the inductor current approaches zero. The LS-FET driver enters a tri-state (high Z) whenever the inductor current reaches zero. A current modulator takes control of the LS-FET and limits the inductor current to less than -1mA. Hence, the output capacitors discharge slowly to GND through the LS-FET to greatly improve the light-load efficiency. At light loads, the HS-FET does not turn ON as frequently as at heavy loads. This is called skip mode.

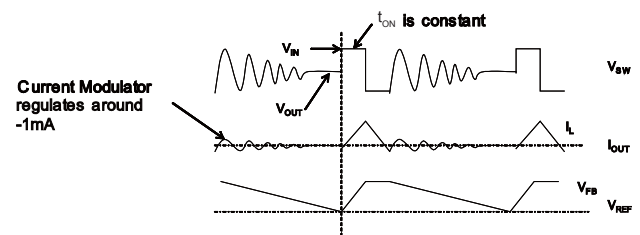

Figure 3: Light-Load Operation

As the output current increases from light-load condition, the current modulator's regulatory time period becomes shorter. The HS-FET turns ON more frequently, thus increasing the switching frequency increases. The output current reaches its critical level when the current modulator time is zero. The critical output current level is:

$$I_{OUT} = \frac{(V_{IN} - V_{OUT}) \times V_{OUT}}{2 \times L \times F_{SW} \times V_{IN}} \quad (2)$$

It enters PWM mode once the output current exceeds the critical level. After that, the switching frequency stays fairly constant over the output current range.

### Switching Frequency

The input voltage is feed-forwarded to the on-time one-shot timer through the resistor,  $R_{FREQ}$ . The duty ratio remains at  $V_{OUT}/V_{IN}$ . Hence, the switching frequency is fairly constant over the input voltage range. The switching frequency can be set as:

$$F_{SW}(\text{kHz}) = \frac{10^6}{\left[ \frac{96 \times R_{FREQ}(\text{k}\Omega)}{V_{IN}} + t_{DELAY}(\text{ns}) \right] \times \frac{V_{IN}}{V_{OUT}}} \quad (3)$$

Where  $t_{DELAY}$  is the comparator delay ( $\sim 20\text{ns}$ ).

The MPQ4470/4470A is optimized for 100kHz-to-1MHz applications to operate at high switching frequencies with high efficiency. The high-switching frequency allows for smaller LC-filter components to reduce PCB space requirements.

### Ramp Compensation

Figure 4 and Figure 5 show jitter occurring in both PWM mode and skip mode. Noise on  $V_{FB}$ 's downward slope causes the HS-FET ON time to deviate from its intended position and produces jitter. There is a relationship between system stability and the steepness of the  $V_{FB}$  ripple: The slope steepness of the  $V_{FB}$  ripple dominates noise immunity. The magnitude of the  $V_{FB}$  ripple doesn't affect the noise immunity directly.

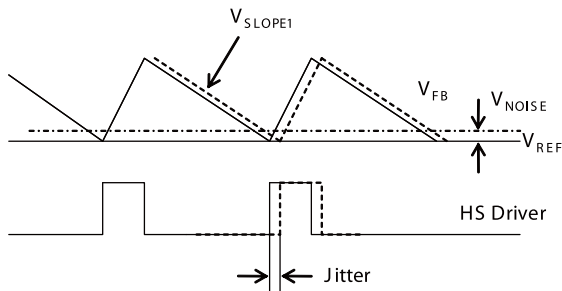

Figure 4: Jitter in PWM Mode

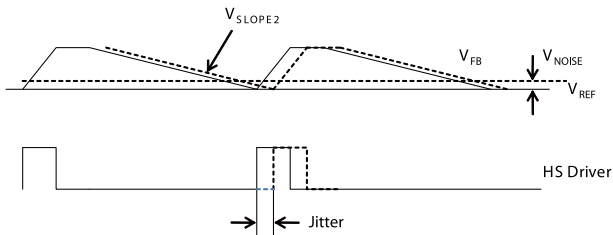

Figure 5: Jitter in Skip Mode

Ceramic output capacitors lack enough ESR ripple to stabilize the system, and requires an external compensation ramp.

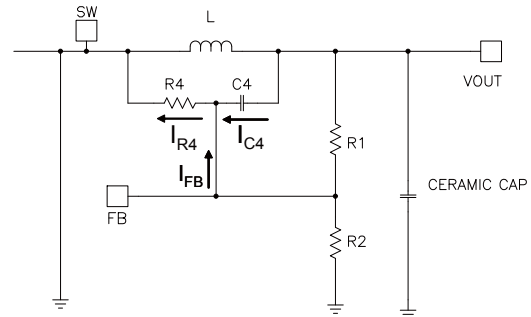

Figure 6: Simplified Circuit in PWM Mode with External Ramp Compensation

In PWM mode has an equivalent circuit with HS-FET OFF and uses an external ramp compensation circuit ( $R_4$ ,  $C_4$ ), shown as a simplified circuit in Figure 6. Derive the external ramp from the inductor-ripple current. Choose  $C_4$ ,  $R_1$ , and  $R_2$  to meet the following condition:

$$\frac{1}{2\pi \times F_{SW} \times C_4} < \frac{1}{5} \times \left( \frac{R_1 \times R_2}{R_1 + R_2} \right) \quad (4)$$

Then:

$$I_{R4} = I_{C4} + I_{FB} \approx I_{C4} \quad (5)$$

The  $V_{FB}$  downward slope ripple is then estimated as:

$$V_{SLOPE1} = \frac{-V_{OUT}}{R_4 \times C_4} \quad (6)$$

From equation 6, reduce  $R_4$  or  $C_4$  to reduce instability in PWM mode. If  $C_4$  cannot be reduced further due to equation 4's limitations, then only reduce  $R_4$ . Based on bench experiments,  $V_{SLOPE1}$  is around 20V/ms-40V/ms.

In the case of POSCAP or other types of capacitors with higher ESR, an external ramp is not necessary.

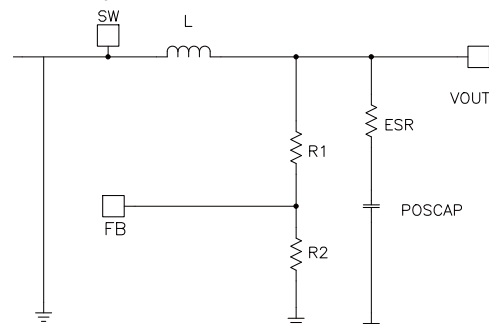

Figure 7: Simplified Circuit in PWM Mode without External Ramp Compensation

Figure 7 shows an equivalent circuit in PWM mode with the HS-FET OFF and without an external ramp circuit. The ESR ripple dominates the output ripple. The  $V_{FB}$  downward slope is:

$$V_{SLOPE1} = \frac{-ESR \times V_{REF}}{L} \quad (7)$$

From equation 7, the  $V_{FB}$  downward slope is proportional to  $ESR/L$ . Therefore, it's necessary to know the minimum ESR value of the output capacitors without an external ramp. There is also an inductance limit: A smaller inductance leads to more stability. Based on bench experiments, keep  $V_{SLOPE1}$  around 15V/ms to 30V/ms.

In skip mode, the external ramp does not affect the downward slope, and  $V_{FB}$  ripple's downward slope is the same with or without the external ramp. Figure 8 shows an equivalent circuit with the HS-FET off and the current modulator regulating the LS-FET.

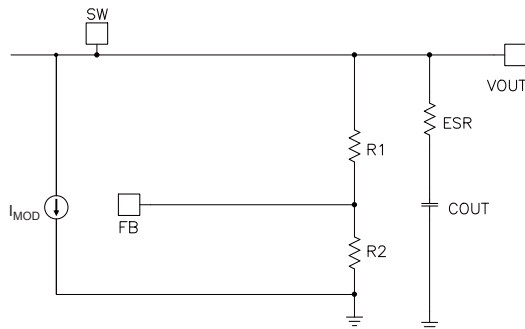

**Figure 8: Simplified Circuit in Skip Mode**

The  $V_{FB}$  ripple's downward slope is:

$$V_{SLOPE2} = \frac{-V_{REF}}{(R_1 + R_2) \times C_{OUT}} \quad (8)$$

To keep the system stable during light loads, avoid large  $V_{FB}$  resistors. Also, keep the  $V_{SLOPE2}$  value around 0.4V/ms to 0.8mV/ms. Note that  $I_{MOD}$  is excluded from the equation because it does not impact the system's light-load stability.

### Enable Control

The MPQ4470/4470A has a dedicated enable-control pin EN. After  $V_{IN}$  goes high, drive EN high to turn on the chip, drive EN low to turn the chip off. EN falling threshold is a consistent 0.86V. Its rising threshold is about 390mV higher. When

floating, EN pin is internally pulled down to GND to disable the chip.

Internally a zener diode is connected from EN pin to GND pin. The typical clamping voltage of the zener diode is 6.5V. So  $V_{IN}$  can be connected to EN through a high ohm resistor if the system doesn't have another logic input acting as enable signal. The resistor needs to be designed to limit the EN sink current less than 150 $\mu$ A. Just note that there is an internal 1M resistor from EN to GND, so the external pull up resistor should be smaller than  $\frac{[V_{IN(MIN)} - 1.25V] \times 1M}{1.25V}$  to make sure the part can EN on at the lowest operation  $V_{IN}$ .

### Soft-Start

The MPQ4470/4470A employs soft start (SS) to ensure a smooth output during power-up. When the EN pin goes HIGH, an internal current source (8.5 $\mu$ A) charges up the SS capacitor ( $C_{SS}$ ). The  $C_{SS}$  voltage takes over the REF voltage to the PWM comparator. The output voltage smoothly ramps up with  $V_{SS}$ . Once  $V_{SS}$  reaches the same level as  $V_{REF}$ , it continues ramping up while  $V_{REF}$  takes over the PWM comparator. At this point, soft-start finishes and the MPQ4470/4470A enters steady-state.

$C_{SS}$  is then:

$$C_{SS} \text{ (nF)} = \frac{t_{SS} \text{ (ms)} \times I_{SS} \text{ (\mu A)}}{V_{REF} \text{ (V)}} \quad (9)$$

If the output capacitors have large capacitance values, avoid setting a short SS or risk hitting the current limit during SS. Select a minimum value of 4.7nF if the output capacitance value exceeds 330 $\mu$ F.

### Power Good (PGOOD)

The MPQ4470/4470A has power-good (PGOOD) output. The PGOOD pin is the open drain of a MOSFET. It should connect to  $V_{CC}$  or some other voltage source through a resistor (e.g. 100k $\Omega$ ). In the presence of an input voltage, the MOSFET turns ON so that the PGOOD pin is pulled to GND before SS is ready. After  $V_{FB}$  reaches 90% $\times V_{REF}$ , the PGOOD pin is pulled HIGH after a delay; typically 700 $\mu$ s.

When the FB voltage drops to 85% $\times V_{REF}$ , the PGOOD pin is pulled LOW.

### Over-Current Protection (OCP) and Short-Circuit Protection (SCP)

The MPQ4470/4470A has cycle-by-cycle over-current limit control. The inductor current is monitored during the ON state. Once the inductor current exceeds the current limit, the HS-FET turns OFF. At the same time, the OCP timer starts. The OCP timer is set at 100 $\mu$ s. Hitting the current limit during each cycle during this 100 $\mu$ s time frame will trigger hiccup SCP.

If a short circuit occurs, the MPQ4470/4470A will immediately hit its current limit and  $V_{FB}$  will drop below 50% $\times V_{REF}$  (0.815V). The device considers this an output dead short and will trigger hiccup SCP immediately.

### Over/Under-Voltage Protection (OVP/UVP)

The MPQ4470 monitors the output voltage through the tap of a resistor divider to the FB pin to detect output over-voltage conditions. A  $V_{FB}$  that exceeds 125% $\times V_{REF}$  (0.815V) triggers OVP latch-off. Once OVP triggers, the LS-FET turns on to discharge  $V_O$  until the inductor current drops to zero while the HS-FET remains off. The MPQ4470 needs to power cycle to restart. Note that MPQ4470A has no this OVP function.

The MPQ4470/4470A also monitors FB pin voltage to detect output under-voltage condition. A  $V_{FB}$  drop below 50%  $\times V_{REF}$  triggers UVP as well as a current-limit that triggers SCP.

### UVLO Protection

The MPQ4470/4470A has under-voltage lock-out protection (UVLO). When the input voltage is higher than the UVLO rising threshold voltage, the MPQ4470/4470A will be powered up. It shuts off when the input voltage is lower than the UVLO falling threshold voltage. This is non-latch protection.

### Floating Driver and Bootstrap Charging

An external bootstrap capacitor power the floating-power-MOSFET driver. A dedicated internal regulator charges and regulates the bootstrap capacitor voltage to ~5V. When the voltage between the BST and SW nodes drops below regulation, a PMOS pass transistor connected from  $V_{IN}$  to BST turns on. The charging current path is from  $V_{IN}$ , BST and then to SW. The external circuit should provide

enough voltage headroom to facilitate charging.

As long as  $V_{IN}$  is significantly higher than SW, the bootstrap capacitor remains charged. When the HS-FET is ON,  $V_{IN}\approx V_{SW}$  so the bootstrap capacitor cannot charge.

When the LS-FET is ON,  $V_{IN}-V_{SW}$  reaches its maximum for fast charging. When there is no inductor current,  $V_{SW}=V_{OUT}$  so the difference between  $V_{IN}$  and  $V_{OUT}$  can charge the bootstrap capacitor.

At higher duty cycles, the bootstrap-charging time is shorter so the bootstrap capacitor may not charge sufficiently. In case the internal circuit has insufficient voltage and time to charge the bootstrap capacitor, the bootstrap capacitor voltage will drop low. When  $V_{BST}-V_{SW}$  drops below 2.3V, the HS-FET turns OFF. A UVLO circuit allows the LS-FET to conduct and refresh the charge on the bootstrap capacitor. Once bootstrap capacitor voltage is charged, the HS-FET can turn on again and the part resumes normal switching. With this bootstrap refreshing function, MPQ4470/4470A is able to work on the low drop-out mode.

### Thermal Shutdown

The MPQ4470/4470A uses thermal shutdown. The junction temperature of the IC is internally monitored. If the junction temperature exceeds the threshold value (typically 175°C), the converter shuts off. This is a non-latched protection. There is about 45°C hysteresis. Once the junction temperature drops to about 130°C, it initiates a SS.



## APPLICATION INFORMATION

### Setting the Output Voltage

A resistor divider from the output voltage to the FB pin set  $V_{OUT}$ .

Without an external ramp employed, the feedback resistors ( $R_1$  and  $R_2$ ) set the output voltage. To determine the values for the resistors, first, choose  $R_2$  (typically 5k $\Omega$ -40k $\Omega$ ). Then  $R_1$  is:

$$R_1 = \frac{V_{OUT} - V_{REF}}{V_{REF}} \times R_2 \quad (10)$$

When using a low-ESR ceramic capacitor on the output, add an external voltage ramp to the FB pin through  $R_4$  and  $C_4$ . The ramp voltage ( $V_{RAMP}$ ) affects output voltage. Calculate  $V_{RAMP}$  as per equation 18. Choose  $R_2$  between 5k $\Omega$  and 40k $\Omega$ . Determine  $R_1$  as:

$$R_1 = \left( \frac{V_{REF} + \frac{1}{2} V_{RAMP}}{R_2 \times (V_{OUT} - V_{REF} - \frac{1}{2} V_{RAMP})} - \frac{1}{R_4} \right)^{-1} \quad (11)$$

Using equation 11 to calculate the output voltage can be complicated. Furthermore, as  $V_{RAMP}$  changes due to changes in  $V_{OUT}$  and  $V_{IN}$ ,  $V_{FB}$  also varies. To improve the output voltage accuracy and simplify the  $R_2$  calculation from equation 11, add a DC-blocking capacitor ( $C_{DC}$ ). Figure 9 shows a simplified circuit with external ramp compensation and a DC-blocking capacitor. Equation 10 can then estimate  $R_1$

Select a  $C_{DC}$  value between 1 $\mu$ F and 4.7 $\mu$ F to improve DC-blocking performance.

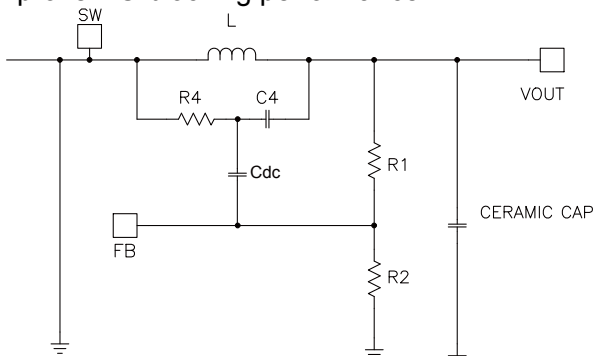

**Figure 9: Simplified Circuit with External Ramp Compensation and DC Blocking Capacitor**

### Input Capacitor

The input current to the step-down converter is discontinuous, and Therefore requires a capacitor to supply the AC current to the step-down converter while maintaining the DC input voltage. Ceramic capacitors are recommended for best performance. Be sure to place the input capacitors as close to the IN pin as possible.

The capacitance varies significantly with temperature. Capacitors with X5R and X7R ceramic dielectrics are fairly stable over temperature fluctuations.

The capacitors must also have a ripple-current rating greater than the converter's maximum input-ripple current. The input ripple current can be estimated as follows:

$$I_{CIN} = I_{OUT} \times \sqrt{\frac{V_{OUT}}{V_{IN}} \times \left(1 - \frac{V_{OUT}}{V_{IN}}\right)} \quad (12)$$

The worst-case condition occurs at  $V_{IN} = 2V_{OUT}$ , where:

$$I_{CIN} = \frac{I_{OUT}}{2} \quad (13)$$

For simplification, choose an input capacitor whose RMS current rating is greater than half of the maximum load current. The input capacitance value determines the input voltage ripple of the converter. If there is an input-voltage-ripple requirement in the system design, choose an input capacitor that meets the specification

The input voltage ripple can be estimated as follows:

$$\Delta V_{IN} = \frac{I_{OUT}}{F_{SW} \times C_{IN}} \times \frac{V_{OUT}}{V_{IN}} \times \left(1 - \frac{V_{OUT}}{V_{IN}}\right) \quad (14)$$

The worst-case condition occurs at  $V_{IN} = 2V_{OUT}$ , where:

$$\Delta V_{IN} = \frac{1}{4} \times \frac{I_{OUT}}{F_{SW} \times C_{IN}} \quad (15)$$

### Output Capacitor

The output capacitor maintains the DC output voltage. Use ceramic or POSCAP capacitors. The output voltage ripple can be estimated as:

$$\Delta V_{OUT} = \frac{V_{OUT}}{F_{SW} \times L} \times \left(1 - \frac{V_{OUT}}{V_{IN}}\right) \times \left(R_{ESR} + \frac{1}{8 \times F_{SW} \times C_{OUT}}\right) \quad (16)$$

Where  $R_{ESR}$  is the equivalent series resistance of the output capacitor.

For ceramic capacitors, capacitance dominates the impedance at the switching frequency, can be the primary cause of the output-voltage ripple. For simplification, estimate the output voltage ripple as:

$$\Delta V_{OUT} = \frac{V_{OUT}}{8 \times F_{SW}^2 \times L \times C_{OUT}} \times \left(1 - \frac{V_{OUT}}{V_{IN}}\right) \quad (17)$$

The output voltage ripple caused by ESR is very small and therefore requires an external ramp to stabilize the system. The voltage ramp is ~30mV. The external ramp can be generated through  $R_4$  and  $C_4$  using the following equation:

$$V_{RAMP} = \frac{(V_{IN} - V_{OUT}) \times T_{ON}}{R_4 \times C_4} \quad (18)$$

Select  $C_4$  to meet the following condition:

$$\frac{1}{2\pi \times F_{SW} \times C_4} < \frac{1}{5} \times \left(\frac{R_1 \times R_2}{R_1 + R_2}\right) \quad (19)$$

For POSCAP capacitors, the ESR dominates the impedance at the switching frequency. The ramp voltage generated from the ESR is high enough to stabilize the system. Therefore, an external ramp is not needed. A minimum ESR value of 12m $\Omega$  is required to ensure stable operation of the converter. For simplification, the output ripple can be approximated as:

$$\Delta V_{OUT} = \frac{V_{OUT}}{F_{SW} \times L} \times \left(1 - \frac{V_{OUT}}{V_{IN}}\right) \times R_{ESR} \quad (20)$$

### Inductor

The inductor is required to supply constant current to the output load while being driven by the switching input voltage. A larger inductance will result in less ripple current and a lower output ripple voltage. However, a larger inductance results in a larger inductor, which will physically be larger, and have a higher series resistance and/or lower saturation current. A good rule for determining the inductor value is to allow the peak-to-peak ripple current in the inductor to be approximately 30% to 40% of the maximum switch current limit. Ensure that the peak inductor current is below the maximum switch current limit. The inductance value can be calculated as:

$$L = \frac{V_{OUT}}{F_{SW} \times \Delta I_L} \times \left(1 - \frac{V_{OUT}}{V_{IN}}\right) \quad (21)$$

Where  $\Delta I_L$  is the peak-to-peak inductor ripple current.

Choose an inductor that will not saturate under the maximum inductor peak current. The peak inductor current can be calculated as:

$$I_{LP} = I_{OUT} + \frac{V_{OUT}}{2F_{SW} \times L} \times \left(1 - \frac{V_{OUT}}{V_{IN}}\right) \quad (22)$$

### Typical Design Parameter Tables

The following tables include recommended component values for typical output voltages (3.3V, 5V) and switching frequencies (300kHz, 500kHz, and 700kHz). Refer to Tables 1 through 3 for design cases without external ramp compensation, and Tables 4 through 6 for design cases with external ramp compensation. An external ramp is not needed when using high-ESR capacitors, such as electrolytic or POSCAPs. An external ramp is needed when using low-ESR capacitors, such as ceramic capacitors. For cases not listed in this datasheet, an Excel spreadsheet available through your local sales representative can calculate approximate component values.

**Table 1—300kHz, 24V<sub>IN</sub>**

V <sub>OUT</sub> (V)	L (μH)	R1 (kΩ)	R2 (kΩ)	R <sub>FREQ</sub> (kΩ)
3.3	10	30.1	10	110
5	10	51.1	10	169

**Table 2—500kHz, 24V<sub>IN</sub>**

V <sub>OUT</sub> (V)	L (μH)	R1 (kΩ)	R2 (kΩ)	R <sub>FREQ</sub> (kΩ)
3.3	10	30.1	10	63.4
5	10	51.1	10	100

**Table 3—700kHz, 24V<sub>IN</sub>**

V <sub>OUT</sub> (V)	L (μH)	R1 (kΩ)	R2 (kΩ)	R <sub>FREQ</sub> (kΩ)
3.3	10	30.1	10	44.2
5	10	51.1	10	69.8

**Table 4—300kHz, 24V<sub>IN</sub>**

V <sub>OUT</sub> (V)	L (μH)	R1 (kΩ)	R2 (kΩ)	R4 (kΩ)	C4 (pF)	R <sub>FREQ</sub> (kΩ)
3.3	10	30.9	10	953	390	110
5	10	53.6	10	845	560	169

**Table 5—500kHz, 24V<sub>IN</sub>**

V <sub>OUT</sub> (V)	L (μH)	R1 (kΩ)	R2 (kΩ)	R4 (kΩ)	C4 (pF)	R <sub>FREQ</sub> (kΩ)
3.3	10	31.6	10	620	390	63.4
5	10	53.6	10	845	390	100

**Table 6—700kHz, 24V<sub>IN</sub>**

V <sub>OUT</sub> (V)	L (μH)	R1 (kΩ)	R2 (kΩ)	R4 (kΩ)	C4 (pF)	R <sub>FREQ</sub> (kΩ)
3.3	10	31.6	10	560	390	44.2
5	10	54.9	10	620	390	69.8

## LAYOUT RECOMMENDATION

1. Place high-current paths (GND, IN, and SW) very close to the device with short, direct, and wide traces.
2. Place input capacitors on both VIN sides (PIN8 and PIN19) and as close to the IN and GND pins as possible.
3. Place the decoupling capacitor as close to the VCC and GND pins as possible.
4. Keep the switching node SW short and away from the feedback network.
5. Place the external feedback resistors next to the FB pin. Do not place vias on the FB trace.
6. Keep the BST voltage path (BST, C3, and SW) as short as possible.
7. Connect the bottom IN and SW pads to a large copper area to achieve better thermal performance.
8. A Four-layer layout is strongly recommended to achieve better thermal performance.

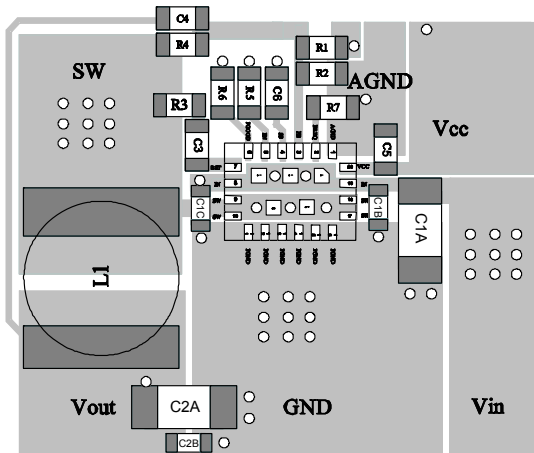

Top Layer

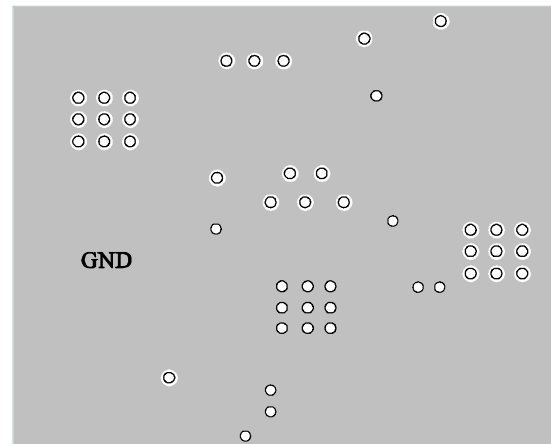

Inner1 Layer

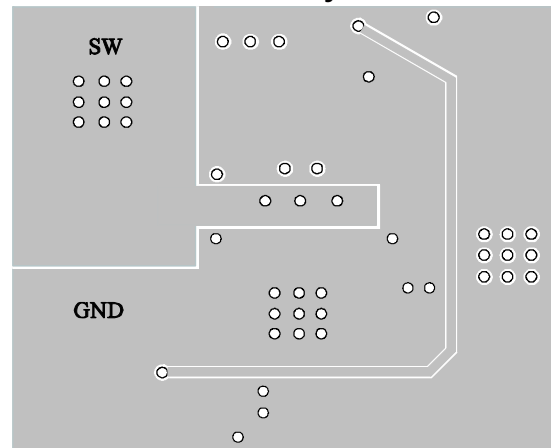

Inner2 Layer

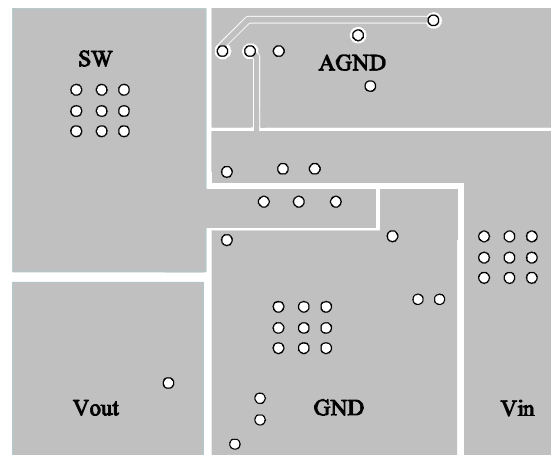

Bottom Layer

Figure 10: PCB Layout

## TYPICAL APPLICATION CIRCUITS

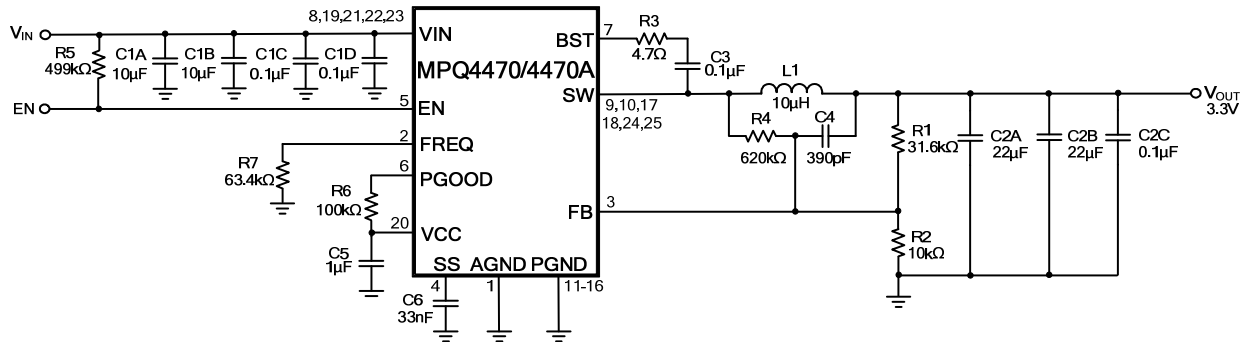
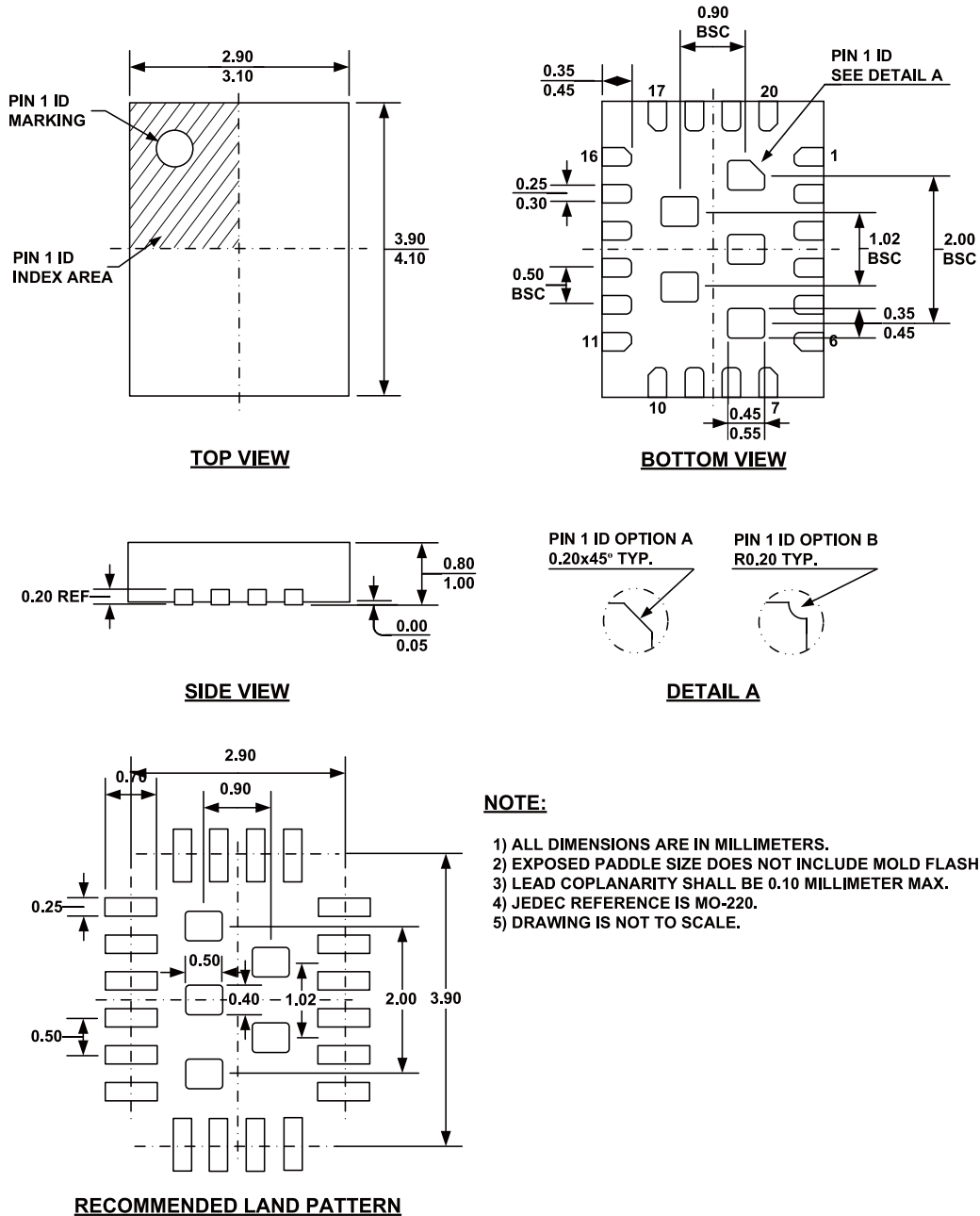

Figure 11: Typical Application Circuit, 3.3V-Output

## PACKAGE INFORMATION

### 3mm × 4mm QFN20



**NOTICE:** The information in this document is subject to change without notice. Users should warrant and guarantee that third party Intellectual Property rights are not infringed upon when integrating MPS products into any application. MPS will not assume any legal responsibility for any said applications.