



The Future of Analog IC Technology®

MPQ5480 Integrated Charger with 5V/100mA DCDC Synchronous Regulator

DESCRIPTION

The MPQ5480 is a monolithic power management solution for wearable device.

It contains a USB compatible, constant current/constant voltage charger along with a high efficiency synchronous step down regulator.

The MPQ5480 also features cell protection and a separate power switch for powering additional power devices.

The hysteresis control scheme provides fast transient response and eases loop stabilization. Fault condition protection includes cycle by cycle current limiting, output short protection and thermal shutdown.

The MPQ5480 requires a minimum number of external components and is available in a WLCSP-16 (1.7mmx1.7mm) package.

FEATURES

- Wide 4V to 6V Charger Input Range
- 100mA DC-DC Output Current
- Feedback Voltage Accuracy: 1%
- 1.22V Default Output Voltage
- Programmable Output Voltage via Resistor Divider (For $V_{OUT} > 1.22V$)
- Integrated Push-button De-bouncer
- Cycle-by-Cycle Over Current Protection
- On Die Thermal Protection
- Stable with Low ESR Output Ceramic Capacitors
- Available in a WLCSP-16 (1.7mmx1.7mm) Package

APPLICATIONS

- Wearable Device
- Other Battery Based Portable Device

All MPS parts are lead-free, halogen-free, and adhere to the RoHS directive. For MPS green status, please visit the MPS website under Quality Assurance.

"MPS" and "The Future of Analog IC Technology" are registered trademarks of Monolithic Power Systems, Inc.

TYPICAL APPLICATION

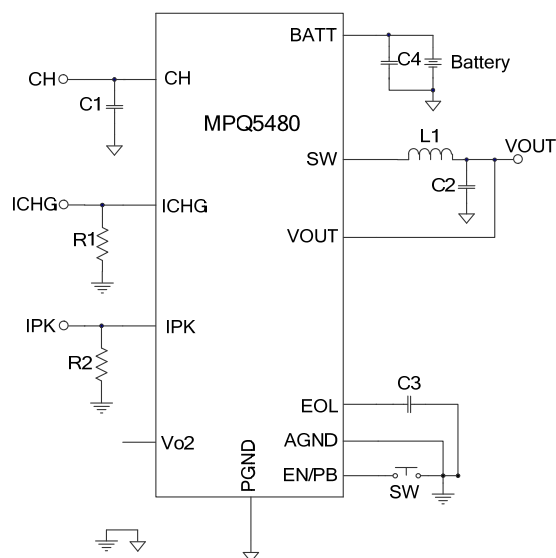

ORDERING INFORMATION

Part Number*	Package	Top Marking
MPQ5480GC	WLCSP-16 (1.7mmx1.7mm)	See Below

* For Tape & Reel, add suffix -Z (e.g. MPQ5480GC-Z);

TOP MARKING

EN: product code of MPQ5480GC;
 Y: year code;
 LLL: lot number;

PACKAGE REFERENCE

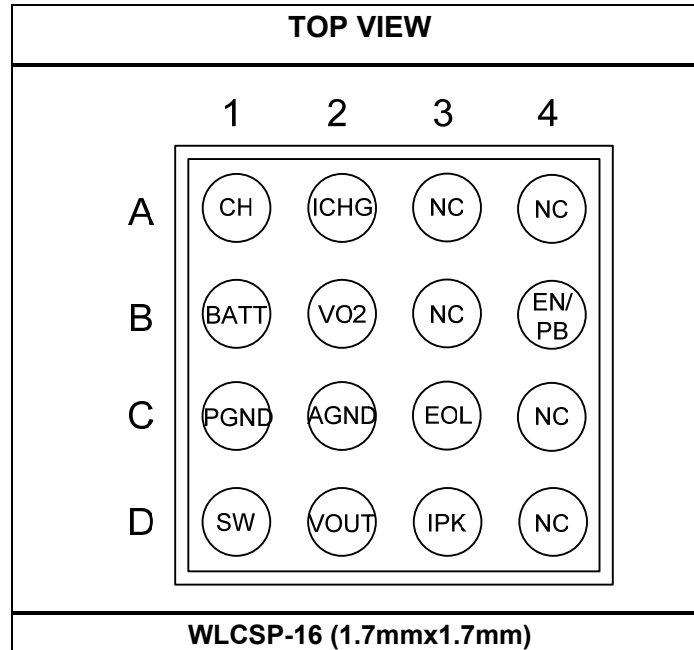

ABSOLUTE MAXIMUM RATINGS ⁽¹⁾

Charger input (V_{CH}).....	-1V to 7V
Battery supply voltage (V_{BATT}).....	-0.3V to 5V
Switch pin voltage (V_{SW})	-0.3V to $V_{BATT}+0.3V$
All other pins	-0.3V to 6.5V
Continuous power dissipation ($T_A = +25^{\circ}C$) ⁽²⁾	1.3W
Junction temperature	150°C
Lead temperature.....	260°C
Storage temperature	-65°C to 150°C

Recommended Operating Conditions

Charger input (V_{CH}).....	4V to 6V
Battery supply voltage (V_{BATT}).....	2.5V to 4.8V
Operating junction temp. (T_J)...	-40°C to +125°C

Thermal Resistance ⁽³⁾	θ_{JA}	θ_{JC}
WLCSP-16 (1.7mmx1.7mm)...	95	1
	°C/W	

Notes:

- 1) Absolute maximum ratings are rated under room temperature unless otherwise noted. Exceeding these ratings may damage the device.
- 2) The maximum allowable power dissipation is a function of the maximum junction temperature T_J (MAX), the junction-to-ambient thermal resistance θ_{JA} , and the ambient temperature T_A . The maximum allowable continuous power dissipation at any ambient temperature is calculated by P_D (MAX) = $(T_J$ (MAX)- T_A)/ θ_{JA} . Exceeding the maximum allowable power dissipation will cause excessive die temperature, and the regulator will go into thermal shutdown. Internal thermal shutdown circuitry protects the device from permanent damage.
- 3) Measured on JESD51-7, 4-layer PCB.

ELECTRICAL CHARACTERISTICS

$V_{BATT}=3.8V$, $V_{CH}=5V$, $L=10\mu H$, $C_{IN}=10\mu F$, $C_{OUT}=10\mu F$, $T_A=+30^\circ C$, unless otherwise noted.

Parameters	Symbol	Condition	Min	Typ	Max	Units
Battery supply current (Shutdown)	I_{SHDN_BATT}	$V_{BATT} < V_{th_UVLO}$		200	350	nA
Battery supply current (OFF)	I_{OFF_BATT}	Push-button state: OFF		8		μA
Battery supply current (quiescent)	I_{Q_BATT}	Push-button state: ON, no switching		40	55	μA
Charger supply current (quiescent)	I_{Q_CH}			170		μA
DC/DC converter						
Output voltage	V_{OUT} (default)	$V_{th_UVLO} \leq V_{BATT} \leq 4.5V$	-1%	1.22	+1%	V
PFET switch on resistance	R_{DSON_P}			950		m Ω
NFET switch on resistance	R_{DSON_N}			375		m Ω
Switch leakage	SW_{LKG}				100	nA
Minimum on time ⁽⁴⁾	T_{ON_MIN}			80		ns
Soft-start time ⁽⁴⁾	t_{SS}	V_{OUT} from 10% to 90%		0.3		ms
Peak current limit	I_{PK}	$R_{IPK}=36.5k\Omega$		50		mA
		$R_{IPK}=17.8k\Omega$ ⁽⁴⁾		100		
		$R_{IPK}=7.87k\Omega$ ⁽⁴⁾		200		
DC/DC SW impedance when OFF	R_{SW}	DC/DC shutdown		1		k Ω
V_{BATT} under-voltage lockout threshold	V_{th_UVLO}		2.95	3.05	3.11	V
Charger						
Charger detection threshold-rising	V_{th_CH}		3.6	3.8	4	V
Charger detection threshold-hysteresis	V_{hys_CH}			300		mV
Battery reverse current to CH pin	V_{REV}	$V_{BATT} = 4V$, CH connected to GND or float			100	nA
Battery charge termination voltage	V_{CV}		-0.5%	4.1	+0.5%	V
Constant current regulation	I_{CHG}	$R_{ICHG} = 169k\Omega$ ⁽⁴⁾		7.8		mA
		$R_{ICHG} = 100k\Omega$	-10%	12	+10%	mA
		$R_{ICHG} = 8.25k\Omega$ ⁽⁴⁾		71		mA
		$R_{ICHG} = 0k\Omega$ ⁽⁴⁾		127		mA

Electrical Characteristics *(continued)*

$V_{BATT}=3.8V$, $V_{CH}=5V$, $L=10\mu H$, $C_{IN}=10\mu F$, $C_{OUT}=10\mu F$, $T_A=+30^{\circ}C$, unless otherwise noted.

Parameters	Symbol	Condition	Min	Typ	Max	Units
Trickle threshold voltage (rising)	V_{th_trich}		2.83	2.93	3.08	V
Trickle voltage hysteresis	V_{hys_trich}			180		mV
Trickle charge current	I_{trich}	$V_{BATT} < V_{th_trich}$	5	10	15	% I_{CHG}
Dropout voltage ($V_{CH} - V_{BATT}$) ⁽⁵⁾	V_{DROP}	$I_{CHG} = 12mA$		400		mV
Thermal operation high limit ⁽⁴⁾		Only for charger		49	54	$^{\circ}C$
Thermal operation low limit ⁽⁴⁾		Only for charger	1	6		$^{\circ}C$
Thermal shutdown hysteresis ⁽⁴⁾		Only for charger		6		$^{\circ}C$
Dead battery detection timer ⁽⁴⁾	T_{DEAD_BATT}		5.95	7	8.05	min
Charging termination current				10		% I_{CHG}
Charging termination timer ⁽⁴⁾			3.6			hour
Push-button controller (No charger connected)						
En pulse input high voltage	V_{EN_HIGH}		1.2			V
En pulse input low voltage	V_{EN_LOW}				0.3	V
Enable push on time (OFF → ON)	T_{PUSH}		1.7	2.2	2.7	s
Disable push time (ON → OFF)	T_{PUSH}		1.7	2.2	2.7	s
System extension Vo2						
Vo2 switch on resistance	R_{DSON_Vo2}			1100		m Ω
Vo2 off impedance				High Z		
Vo2 over current threshold	I_{th_OC}	$I_{CHG}=12mA$		$3.8 * I_{CHG}$		mA
Vo2 short circuit threshold	I_{th_SC}	$I_{CHG}=12mA$		$5 * I_{CHG}$		mA
Vo2 over current detection delay ⁽⁴⁾	T_{DOC}			9		ms
Vo2 short circuit detection delay ⁽⁴⁾	T_{DSC}			300		us
Vo2 protection auto retry delay ⁽⁴⁾	T_{DAR}			75		ms

Notes:

- 4) Guaranteed by design, not tested.
 5) $V_{CH} > V_{BATT} + 400mV$ to guarantee charger works well.

TYPICAL PERFORMANCE CHARACTERISTICS

$V_{BATT} = 3.8V$, $V_{CH} = 5V$, $L = 10\mu H$, $C_{IN} = 10\mu F$, $C_{OUT} = 10\mu F$, $T_A = +30^\circ C$, unless otherwise noted.

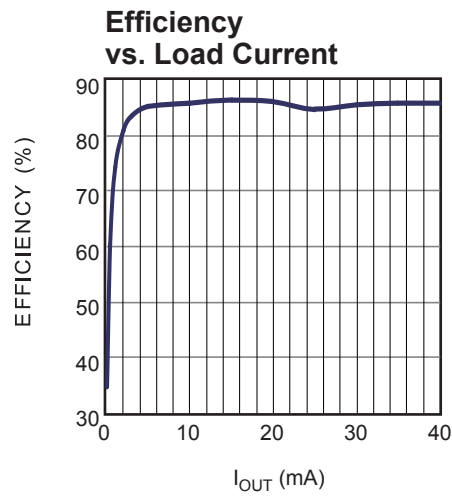

TYPICAL PERFORMANCE CHARACTERISTICS

$V_{BATT} = 3.8V$, $V_{CH} = 5V$, $L = 10\mu H$, $C_{IN} = 10\mu F$, $C_{OUT} = 10\mu F$, $T_A = +30^\circ C$, unless otherwise noted.

DC/DC Section

Steady State

$I_{OUT} = 1mA$

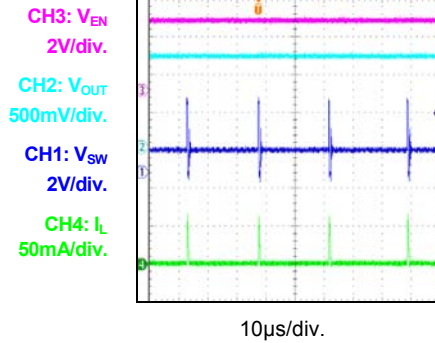

Steady State

$I_{OUT} = 30mA$

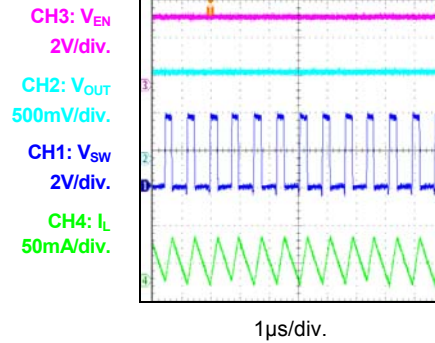

Push-button On

$I_{OUT} = 0A$

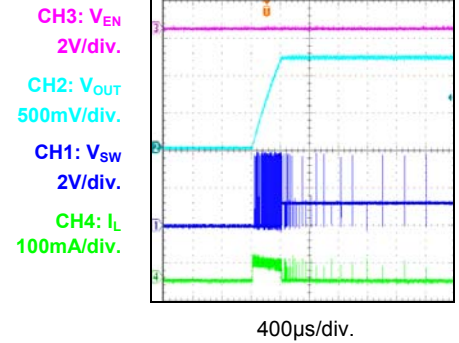

Push-button On

$I_{OUT} = 30mA$

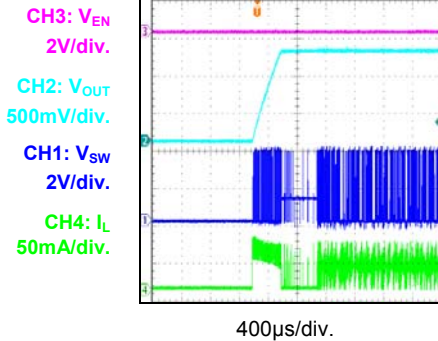

Push-button Off

$I_{OUT} = 0A$

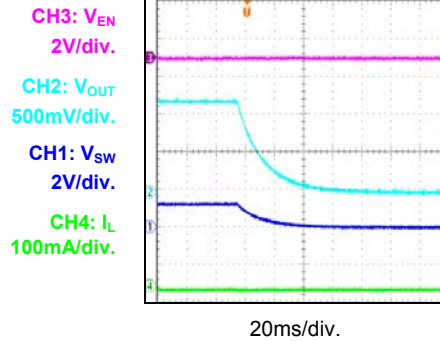

Push-button Off

$I_{OUT} = 30mA$

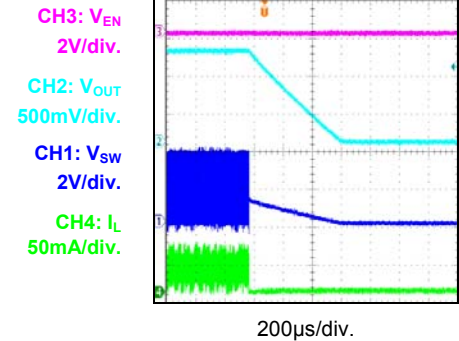

SCP Steady State

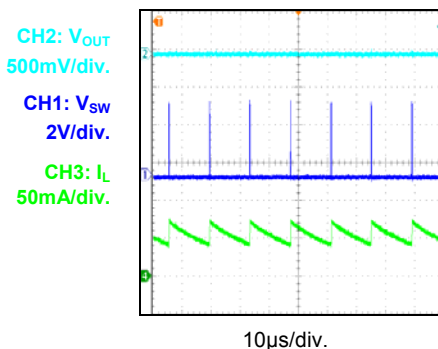

SCP Entry

$I_{OUT} = 0A$ to Short Circuit

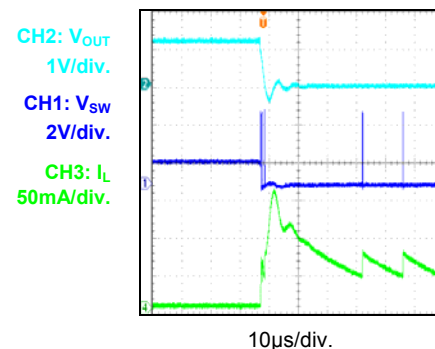

SCP Entry

$I_{OUT} = 30mA$ to Short Circuit

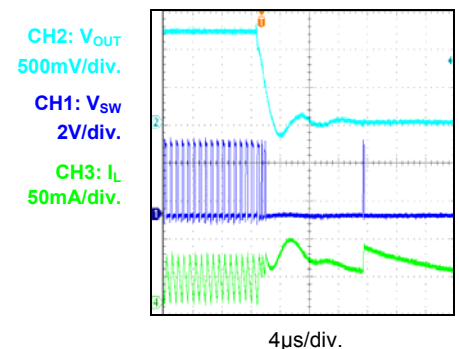

TYPICAL PERFORMANCE CHARACTERISTICS

$V_{BATT} = 3.8V$, $V_{CH} = 5V$, $L = 10\mu H$, $C_{IN} = 10\mu F$, $C_{OUT} = 10\mu F$, $T_A = +30^\circ C$, unless otherwise noted.

DC/DC Section

SCP Recovery

Short Circuit to $I_{OUT} = 0$

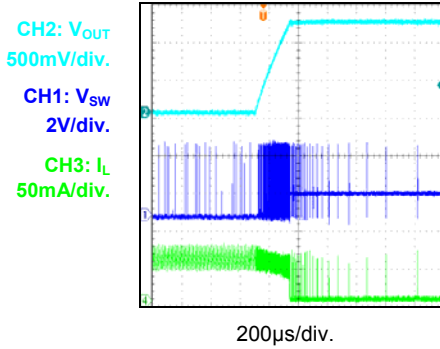

SCP Recovery

Short Circuit to $I_{OUT} = 30mA$

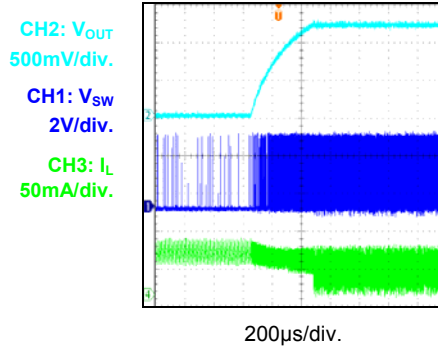

Thermal Shutdown

$I_{OUT} = 30mA$

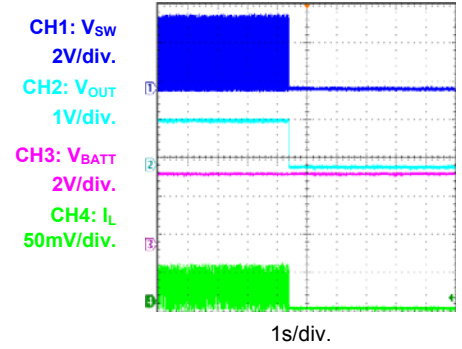

TYPICAL PERFORMANCE CHARACTERISTICS

$V_{BATT} = 3.8V$, $V_{CH} = 5V$, $R_{CHG} = 2.49k\Omega$, $L = 10\mu H$, $C_{IN} = 10\mu F$, $C_{OUT} = 10\mu F$, $T_A = +30^\circ C$, unless otherwise noted.

Charger Section

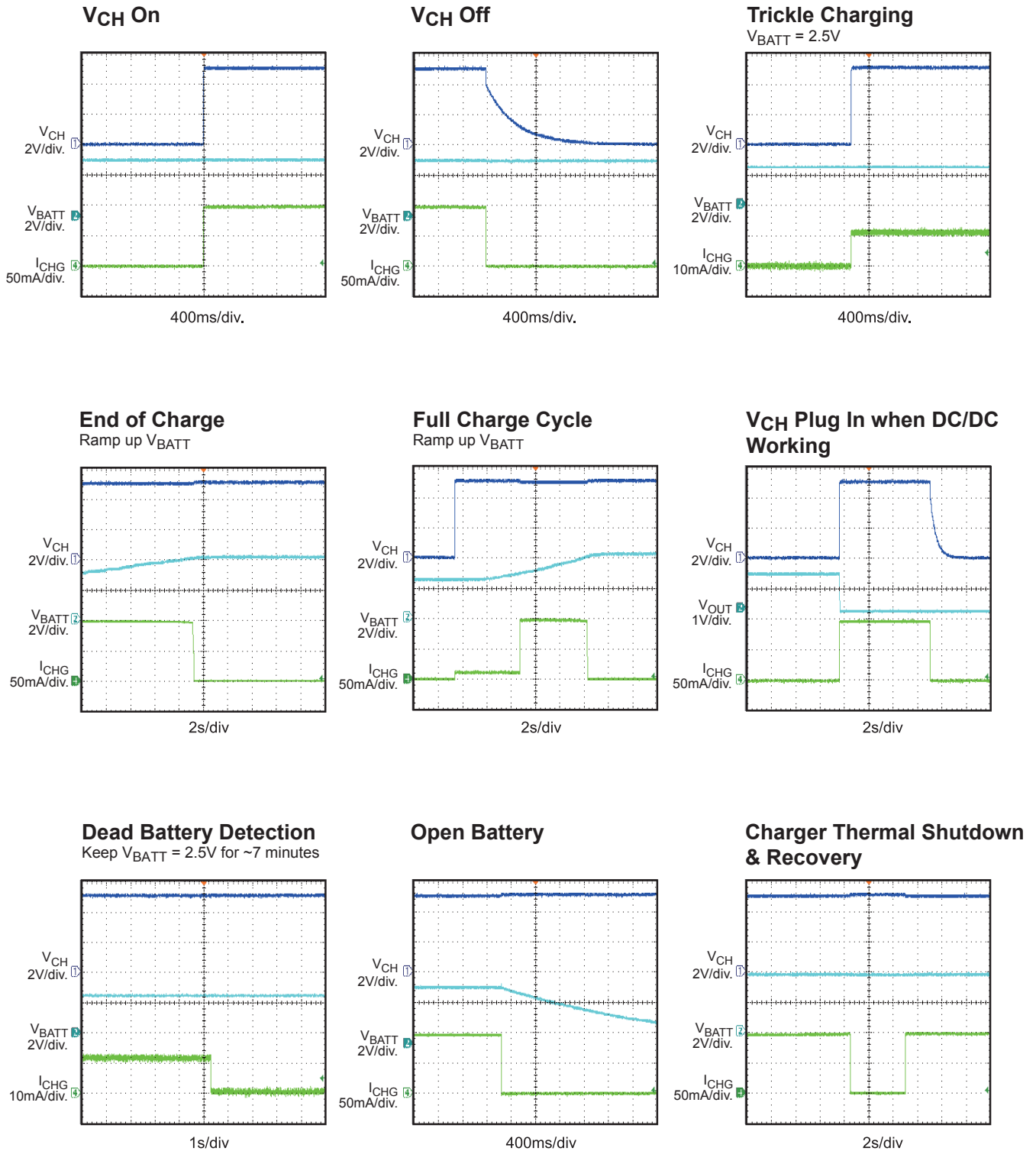

TYPICAL PERFORMANCE CHARACTERISTICS

$V_{BATT} = 3.8V$, $V_{CH} = 5V$, $L = 10\mu H$, $C_{IN} = 10\mu F$, $C_{OUT} = 10\mu F$, $T_A = +30^\circ C$, unless otherwise noted.

Vo2 Function

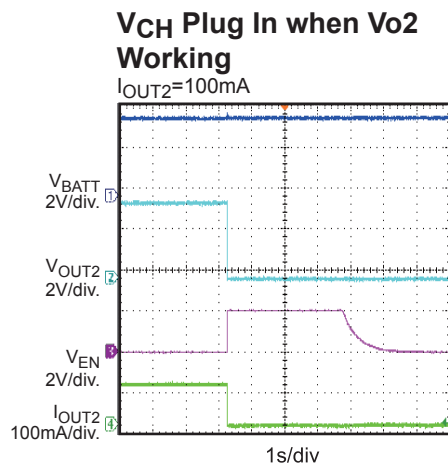
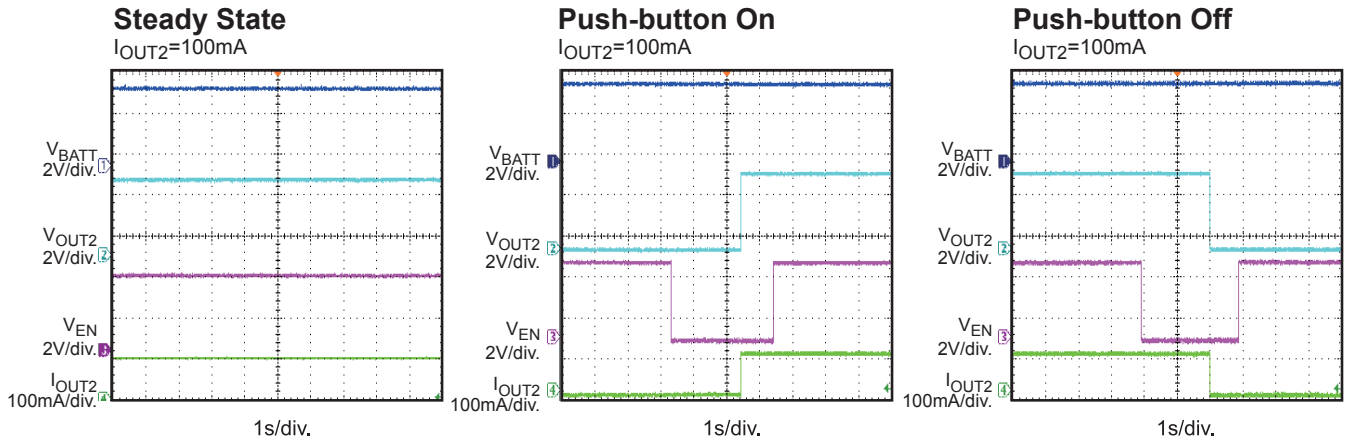

PIN FUNCTIONS (Pin arrangement refer to package top view on page 2)

Pin #	Name	Description
A1	CH	Charger input. USB compatible input voltage for CC/CV lithium-ion battery charger.
A2	ICHG	Charge current set. Connect resistor between this pin and ground to set maximum charge current.
A3	NC	Do not connect. NC must be left floating.
A4	NC	Do not connect. NC must be left floating.
B1	BATT	Connect to Lithium-Ion battery. A decoupling capacitor is needed here.
B2	Vo2	Extension output. Switched pin that provides battery power to external circuitry when device is active.
B3	NC	Do not connect. NC must be left floating.
B4	EN/PB	Enable input, push-button. Toggle control pin for enable/disable DC/DC converter and Vo2. Connect a push-button between this pin and GND.
C1	PGND	Power ground. Reference ground of the power device.
C2	AGND	Analog ground. Reference ground of logic circuit.
C3	EOL	Low battery voltage detection. Connect to a 0.1uF capacitor to provide filtered battery voltage for battery UVLO protection.
C4	NC	Do not connect. NC must be left floating.
D1	SW	Switch output of DC/DC converter. Connect to step-down inductor.
D2	VOUT	Power output of DC/DC converter.
D3	IPK	Peak current set of DC/DC converter. Connect resistor between this pin and ground to set inductor peak current. There is an internal 2kΩ resistor in series with IPK to ensure the peak current not too large even $R_{IPK}=0$.
D4	NC	Do not connect. NC must be left floating.

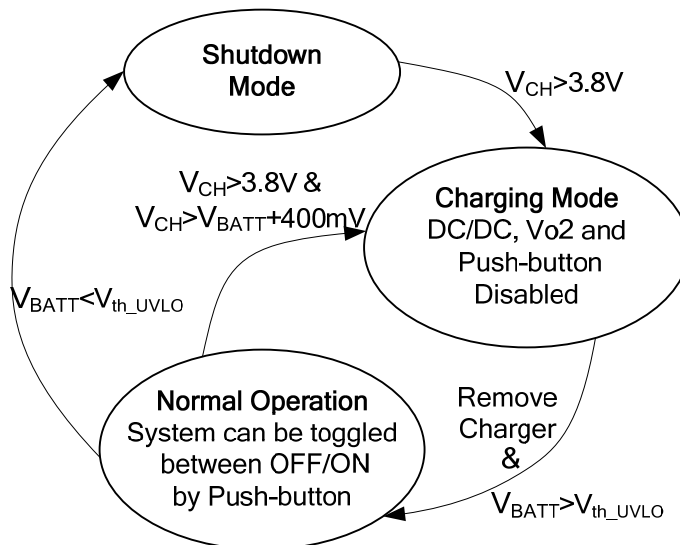

BLOCK DIAGRAM

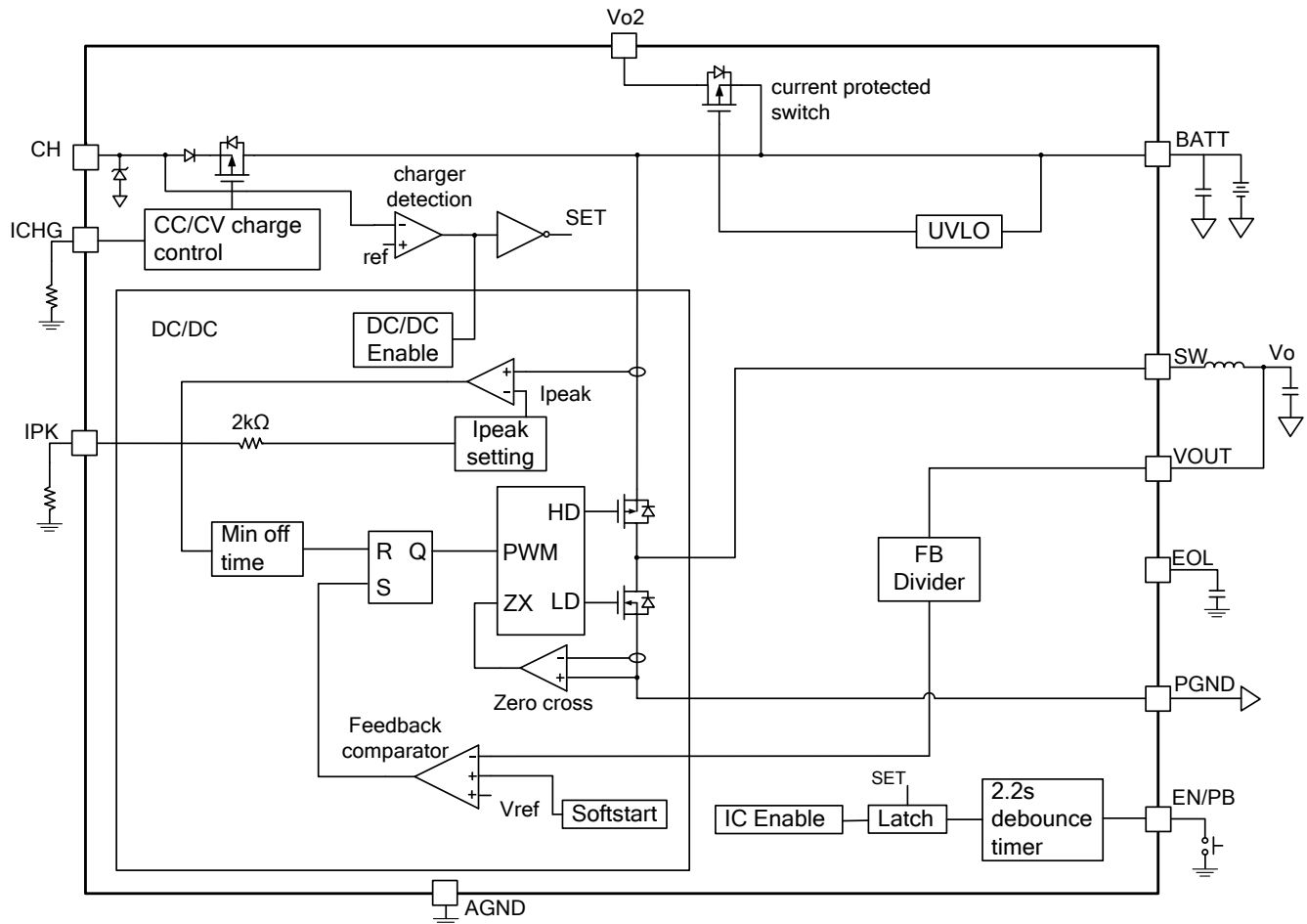

Figure 1: Functional Block Diagram

OPERATION

MPQ5480 is a complete power management solution for Lithium-Ion battery powered device. It integrates a CC/CV charger, cell protection function, high efficiency synchronous buck regulator and a push-button controller.

MPQ5480 has following modes:

Shutdown: When $V_{BATT} < V_{th_UVLO}$, system draws only leakage current from battery and re-activation is only possible by connecting a charger.

Charging: Charger is connected to system. DC/DC, Vo2 and push-button are de-activated. After charger is removed system will be in Normal Operation OFF condition.

Normal Operation (ON/OFF): $V_{BATT} > V_{th_UVLO}$ and no charger is connected. In this mode the system can be turned ON or OFF by toggling the push-button.

Charger

The MPQ5480 integrated linear charger provides CC/CV charging algorithms. It changes charge modes automatically depending on the battery status. A typical charging profile is shown on Figure 2.

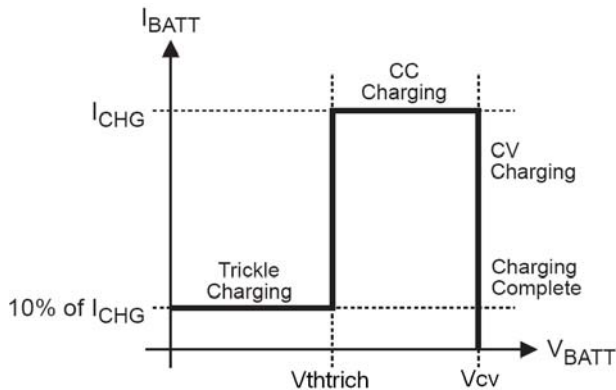

Figure 2: Typical Charging Profile

The defined charging current, I_{CHG} is programmed through resistor R_{ICHG} from ICHG pin to GND. The relationship of the charging current and R_{ICHG} is shown in Table 1 and Figure 3.

Table 1: I_{CHG} vs. R_{ICHG}

I_{CHG} (mA)	R_{ICHG} (k Ω)
7.8	169
10	124
11	110
12	100
21.2	51
34.4	27
51	15
71	8.25
100	2.49
127	0

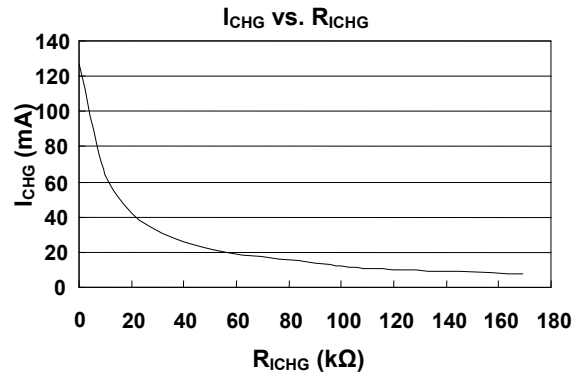

Figure 3: I_{CHG} vs. R_{ICHG}

When battery voltage falls below the trickle falling threshold (V_{th_trich} with $\sim 180mV$ hysteresis), the charging current is limited to 10% of the programmed value to trickle charge the fully depleted battery. After the battery voltage reaches the trickle rising threshold (V_{th_trich}), the charger begins to charge at a constant current of the programmed value (I_{CHG}). I_{CHG} is typically set to C/2. This is referred to as Constant Current (CC) mode. Once the battery voltage reaches CV-Level V_{CV} (e.g. 4.10V), the charger will operate in Constant Voltage (CV) mode until the battery is fully charged. Charging is terminated when the current into the battery falls to 10% of the defined charging current I_{CHG} or the charge termination timer (3.6h) expires.

MPQ5480 also provides an ON Chip temperature sensor to prevent charging outside normal battery temperature limits. The charger will only start to charge when the die temperature is between 6°C and 49°C.

Dead Battery Detection

When the cell voltage is below trickle charge level, the system will therefore start with trickle charge. If the cell voltage will not rise above the threshold within 7 minutes, the IC will consider the battery is dead and stop charging.

High Efficiency DC/DC

The core of the MPQ5480 is a high efficiency integrated synchronous buck to step down the voltage of the battery to a regulated voltage. The peak inductor current is always limited to prevent the damage of the small cell. The default output voltage is set to 1.22V. The max output voltage ripple is controlled to be <80mV for load transients of 45mA/5ms. The over shoot voltage during the startup is controlled to be <150mV. The max output capacitor is up to 250uF. The DC/DC is automatically disabled when charger is connected ($V_{CH}>3.8V$), and can be enabled through push-button when the charger is disconnected ($V_{CH}<3.5V$). When the DC/DC is off, the output impedance is active low to discharge the capacitor.

The output voltage (V_O) can also be set by adding an external resistive voltage divider from the output to VOUT pin (as shown in Figure 4).

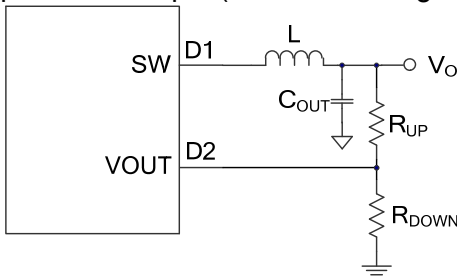

Figure 4: Output voltage set by resistor dividers

To get the desired output voltage, divider resistors can be chosen through below equation:

$$V_O = [1 + R_{UP} / (R_{DOWN} // R_S)] * V_{OUT}$$

Where R_S is the sum of internal FB resistor divider ($R_S=900k\Omega$), V_{OUT} is the 1.22V default output.

The DC/DC converter is controlled through the current limit comparator, output feedback comparator and the zero current comparator. If V_O is below the reference and the min off time is passed, the high-side MOSFET (HS-FET) turns

on, and then the current through the HS-FET is sensed and compared with the current limit threshold. When the current reaches this threshold, the HS-FET turns off immediately. Then the low-side MOSFET (LS-FET) turns on to discharge the inductor current. The LS-FET turns off when zero inductor current is detected. The converter is entering DCM mode and waiting for V_O dropping below the threshold. When V_O drops below the threshold, the HS-FET turns on again and starts another cycle. The converter is normally worked as DCM; while during the load transient, it is able to go into CCM for a fast transient response. This operation will minimize the output cap and still always limit the max input current close to peak current to protect the battery cell. The peak current is set by the resistor on the IPK pin. The relationship of the peak current and R_{IPK} is shown in Table 2 and Figure 5. There is an internal $2k\Omega$ resistor in series with R_{IPK} to ensure the peak current not too large even $R_{IPK}=0$.

Table 2: I_{PK} vs. R_{IPK}

I_{PK} (mA)	R_{IPK} (k Ω)
30	100
45	42.2
50	36.5
100	17.8
200	7.87

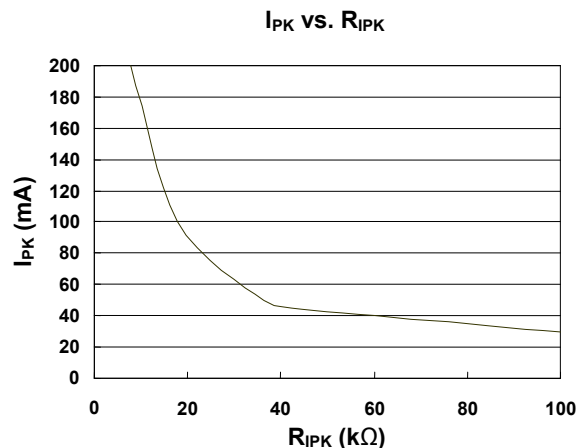

Figure 5: I_{PK} vs. R_{IPK}

The effective switching frequency with a given load can be influenced by the inductor value and IPK setting.

During the light load, the switching frequency will decrease. To prevent the frequency entering the audible band, a proper inductor is needed (when I_{PK} and load is fixed) to keep switching frequency over 20kHz.

The DC/DC features internal soft starts function. The soft start time is about 0.3ms. The soft start voltage (V_{SS}) slowly ramps up from 0V to the internal reference (V_{REF}). When V_{SS} is lower than V_{REF} , V_{SS} overrides V_{REF} as the reference. When V_{SS} exceeds V_{REF} , V_{REF} acts as the reference. With large output cap, it is possible that V_o is not charged to the regulated voltage during the soft start time. At this condition, the converter will charge the output cap with its max current as set by I_{PK} .

Thermal shutdown is implemented to prevent the chip from operating at exceedingly high temperatures. When the die temperature exceeds the upper threshold, the entire chip shuts down. When the die temperature is recovered, the system will be in Normal Operation OFF condition.

Push-button Control

The push-button is a toggle switch input: If the IC is off, a push action of longer than T_{PUSH} will cause the IC to turn on. Additional pressing of longer than T_{PUSH} will cause the IC to turn off. The push-button controller contains an internal timer, and a flip-flop. The debounce timer will start counting when the output of the debouncer is equal to the EN. And resets whenever the EN pin bounce. The output flips when the time is out. When the output of the debouncer is not equal to the EN, the timer will start to count as the idle mode delay timer. When time elapsed, the debouncer goes to idle mode and consumes no power until the EN pin bounces again.

The output of the debouncer then feeds the signal to a flip-flop which is triggered by rising edge to enable/disable the DC/DC and the Vo2 MOSFET.

The output of the flip-flop is forced to low when V_{CH} is connected ($V_{CH} > 3.8V$). it forces the DC/DC and Vo2 MOSFET to be disabled. Toggling the push-button cannot turn on the DC/DC and the Vo2 MOSFET at this condition. When charger is removed ($V_{CH} < 3.5V$), the

output of the flip-flop will stay low, but will flip when push-button is toggled.

The push-button is also disabled when battery voltage is below under-voltage lockout threshold.

$T_{PUSH} > 2.2s$, OFF → ON; and $T_{PUSH} > 2.2s$, ON → OFF.

Push times shorter than T_{PUSH} will be ignored by MPQ5480.

Battery Under-Voltage Protection

The capacitor on the EOL pin acts as a low pass filter to obtain the average voltage of the battery over 1ms (which is depending on the EOL capacitor value). If the low pass filtered battery voltage is lower than V_{th_UVLO} , the DC/DC will be disabled. The MOSFET connected to the Vo2 will also be turned off and the system will be in shutdown mode. Push-button is inactive in this condition. MPQ5480 is latched in this shutdown mode until a valid external power source is connected to CH pin ($V_{CH} > 3.8V$). There is no UVLO hysteresis.

System Extension

MPQ5480 offers a Vo2 pin to extend the power system for more complex application. Additional DC/DC converter can be connected to Vo2 to draw the power from the battery while sharing the power management function of MPQ5480.

When the battery voltage is lower than V_{th_UVLO} , the MOSFET between Vo2 and V_{BATT} will be turned off. During the charge, when $V_{CH} > 3.8V$, the MOSFET is also turned off.

The extension switch also integrates the over current protection and short circuit protection in case too much current is drawn from the battery resulting in cell damage.

When the output current is sensed higher than the over current threshold ($> 3.8 \times I_{CHG}$) but lower than the short circuit threshold ($> 5 \times I_{CHG}$), the switch will turn off after the over current detection delay time ($TD_{OC}=9ms$). When the output current is higher than short circuit threshold ($> 5 \times I_{CHG}$), the switch will turn off after the short circuit detection delay time ($TD_{SC}=300\mu s$). The switch will turn on again after the auto retry time delay ($TD_{AR}=75ms$). In case that the battery voltage is lower than V_{th_UVLO} , the auto retry will not happen.

The timing charts are shown in Figure 6 and Figure 7.

Four events can shut down Vo2: toggling the push-button, charger is connected, $V_{BATT} < V_{th_UVLO}$, and thermal shutdown.

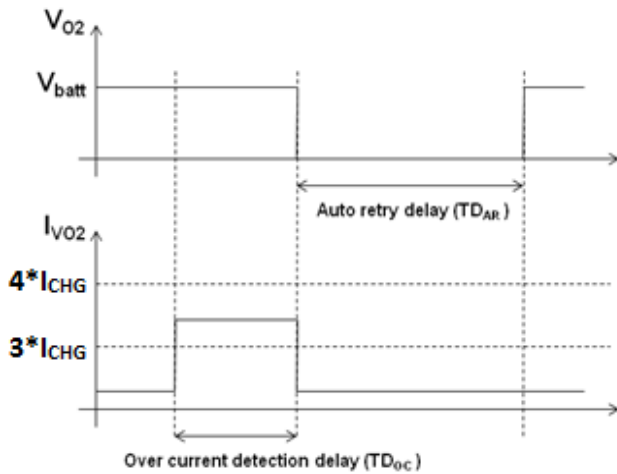

Figure 6: Vo2 over current detection

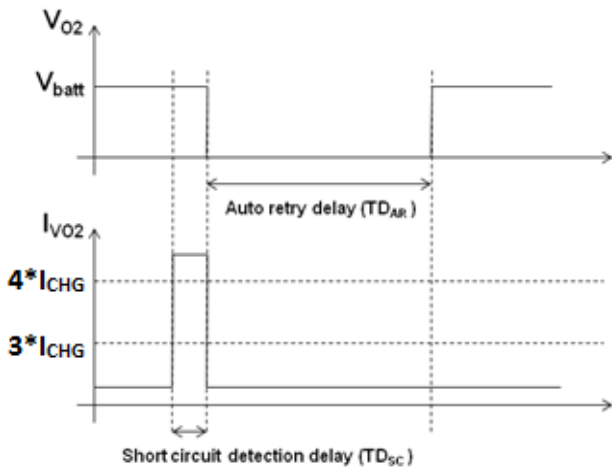
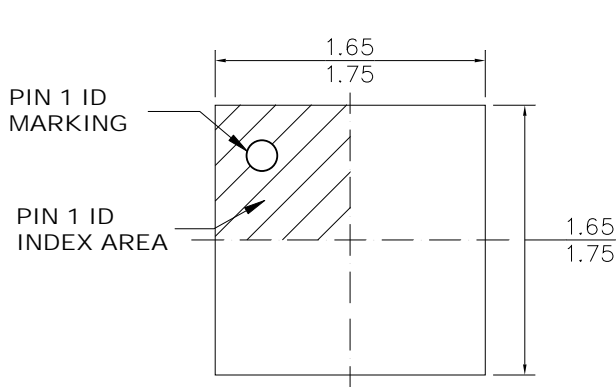

Figure 7: Vo2 short circuit detection

PACKAGE INFORMATION

WLCSP-16 (1.7mmx1.7mm)



TOP VIEW

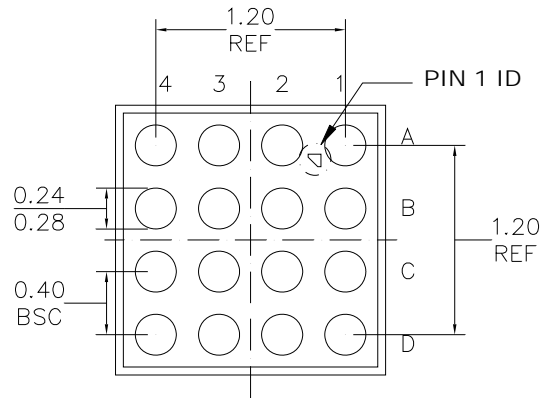

BOTTOM VIEW

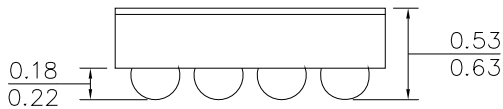

SIDE VIEW

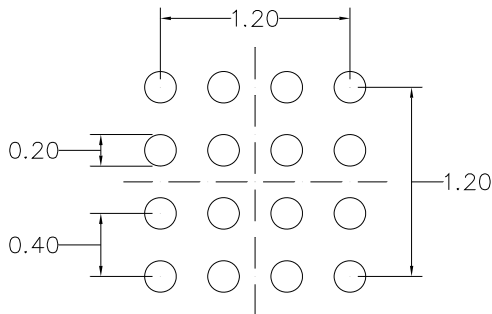

RECOMMENDED LAND PATTERN

NOTE:

- 1) ALL DIMENSIONS ARE IN MILLIMETERS.
- 2) BALL COPLANARITY SHALL BE 0.05 MILLIMETER MAX.
- 3) JEDEC REFERENCE IS MO-211.
- 4) DRAWING IS NOT TO SCALE.

NOTICE: The information in this document is subject to change without notice. Users should warrant and guarantee that third party Intellectual Property rights are not infringed upon when integrating MPS products into any application. MPS will not assume any legal responsibility for any said applications.