

DESCRIPTION

The MP1606 is a monolithic, step-down, switch-mode converter with built-in internal power MOSFETs. It achieves 2A continuous output current from a 2.5V to 5.5V input voltage with excellent load and line regulation. The MP1606 provides different fixed output voltages with PG functionality.

The constant-on-time (COT) control scheme provides fast transient response and eases loop stabilization. Fault protections include cycle-by-cycle current limiting and thermal shutdown.

The MP1606 is available in an ultra-small SOT563 package and requires a minimal number of readily available, standard external components.

The MP1606 is ideal for a wide range of applications, including high-performance DSPs, wireless power, portable and mobile devices, and other low-power systems.

FEATURES

- Low I_Q : 30 μ A
- 1.1MHz Switching Frequency
- EN for Power Sequencing
- 1% Output Voltage Accuracy
- Wide 2.5V to 5.5V Operating Input Range
- V_{OUT} : 0.8/0.9/1.0/1.2/1.35/2.0/2.85/3.2V
- Power Good
- Up to 2A Output Current
- 75m Ω and 45m Ω Internal Power MOSFET Switches
- 100% Duty On
- Output Discharge
- V_O OVP
- Short-Circuit Protection with Hiccup Mode
- Available in a SOT563 Package

APPLICATIONS

- Wireless/Networking Cards
- Solid State Drives (SSD)
- Battery Powered Devices
- Low Voltage I/O System Power
- Multi Function Printer

All MPS parts are lead-free, halogen free, and adhere to the RoHS directive. For MPS green status, please visit MPS website under Quality Assurance.

"MPS" and "The Future of Analog IC Technology" are Registered Trademarks of Monolithic Power Systems, Inc.

TYPICAL APPLICATION

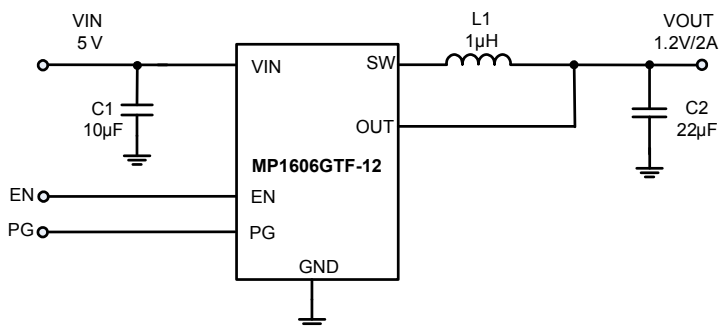

Efficiency vs. Output Current

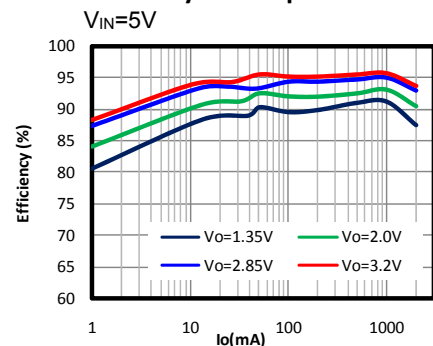

ORDERING INFORMATION

Part Number*	Package	Top Marking	V _{OUT} Range
MP1606GTF-08	SOT563	<i>See Below</i>	0.8V
MP1606GTF-09		<i>See Below</i>	0.9V
MP1606GTF-10		<i>See Below</i>	1.0V
MP1606GTF-12		<i>See Below</i>	1.2V
MP1606GTF-135		<i>See Below</i>	1.35V
MP1606GTF-20		<i>See Below</i>	2.0V

* For Tape & Reel, add suffix -Z (e.g. MP1606GTF-xx-Z);

TOP MARKING

AZNY

LLL

AZN: Product code of MP1606GTF-08

Y: Year code

LLL: Lot number

TOP MARKING

AZPY

LLL

AZP: Product code of MP1606GTF-09

Y: Year code

LLL: Lot number

TOP MARKING

AZQY

LLL

AZQ: Product code of MP1606GTF-10

Y: Year code

LLL: Lot number



TOP MARKING

AYAY

LLL

AYA: Product code of MP1606GTF-12
Y: Year code
LLL: Lot number

TOP MARKING

AZMY

LLL

AZM: Product code of MP1606GTF-135
Y: Year code
LLL: Lot number

TOP MARKING

AZLY

LLL

AZL: Product code of MP1606GTF-20
Y: Year code
LLL: Lot number

PACKAGE REFERENCE

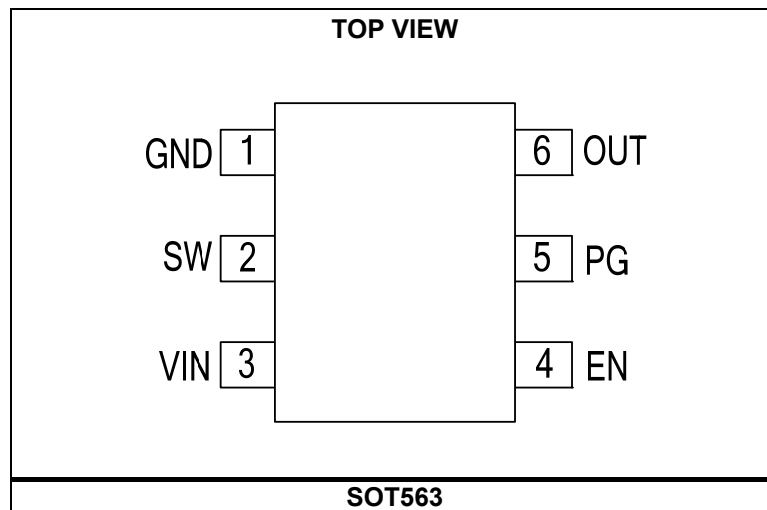

PIN FUNCTIONS

Pin #	Name	Description
1	GND	Power ground.
2	SW	Output switching node. SW is the drain of the internal high-side P-Channel MOSFET. Connect the inductor to SW to complete the converter.
3	VIN	Supply voltage. The MP1606 operates from a +2.5V to +5.5V unregulated input. A decoupling capacitor is needed to prevent large voltage spikes from appearing at the input.
4	EN	On/Off control.
5	PG	Power Good indicator. The output of this pin is an open drain and needs an external pull-up resistor to VIN.
6	OUT	Output voltage power rail and input sense pin for output voltage. Connect the load to this pin. An output capacitor is needed to decrease the output voltage ripple.

ABSOLUTE MAXIMUM RATINGS ⁽¹⁾

Supply voltage (V_{IN})	6.5V
V_{SW}	-0.3V (-3V for <10ns) to 6.5V (8V for <10ns)
All other pins	-0.3V to 6.5 V
Junction temperature	150°C
Lead temperature	260°C
Continuous power dissipation ($T_A = +25^\circ\text{C}$) ⁽²⁾⁽⁴⁾	1.5W
Storage temperature	-65°C to +150°C

Recommended Operating Conditions ⁽³⁾

Supply voltage (V_{IN})	2.5V to 5.5V
Operating junction temp. (T_J).....	-40°C to +125°C

Thermal Resistance	θ_{JA}	θ_{JC}
EV1606-TF-00A ⁽⁴⁾	80.....	50... °C/W
JESD51-7 ⁽⁵⁾	130.....	60... °C/W

Notes:

- 1) Exceeding these ratings may damage the device.
 - 2) The maximum allowable power dissipation is a function of the maximum junction temperature T_J (MAX), the junction-to-ambient thermal resistance θ_{JA} , and the ambient temperature T_A . The maximum allowable continuous power dissipation at any ambient temperature is calculated by P_D (MAX) = $(T_J$ (MAX)- T_A)/ θ_{JA} . Exceeding the maximum allowable power dissipation will cause excessive die temperature, and the regulator will go into thermal shutdown. Internal thermal shutdown circuitry protects the device from permanent damage.
 - 3) The device is not guaranteed to function outside of its operating conditions.
 - 4) Measured on MPS demo board, 2-layer PCB, 63mm×63mm.
 - 5) Measured on JESD51-7, 4-layer PCB.
- note 5) The value of θ_{JA} given in this table is only valid for comparison with other packages and cannot be used for design purposes. These values are calculated in accordance with JESD51-7, and simulated on a specified JEDEC board. They do not represent the performance obtained in an actual application.

ELECTRICAL CHARACTERISTICS

$V_{IN} = 3.6V$, $T_J = -40^{\circ}C$ to $+125^{\circ}C$ ⁽⁶⁾, Typical value is tested at $T_J = +25^{\circ}C$. The limit over temperature is guaranteed by characterization, unless otherwise noted.

Parameter	Symbol	Condition	Min	Typ	Max	Units
V_{IN} range			2.5		5.5	V
Under-voltage lockout threshold rising				2.3	2.45	V
Under-voltage lockout threshold hysteresis				200		mV
MP1606GTF-08	V_o	$T_J=25^{\circ}C$	792	800	808	mV
		$T_J=-40^{\circ}C$ to $+125^{\circ}C$	788	800	812	
MP1606GTF-09	V_o	$T_J=25^{\circ}C$	891	900	909	mV
		$T_J=-40^{\circ}C$ to $+125^{\circ}C$	887	900	913	
MP1606GTF-10	V_o	$T_J=25^{\circ}C$	990	1000	1010	mV
		$T_J=-40^{\circ}C$ to $+125^{\circ}C$	985	1000	1015	
MP1606GTF-12	V_o	$T_J=25^{\circ}C$	1188	1200	1212	mV
		$T_J=-40^{\circ}C$ to $+125^{\circ}C$	1182	1200	1218	
MP1606GTF-135	V_o	$T_J=25^{\circ}C$	1337	1350	1363	mV
		$T_J=-40^{\circ}C$ to $+125^{\circ}C$	1330	1350	1370	
MP1606GTF-20	V_o	$T_J=25^{\circ}C$	1980	2000	2020	mV
		$T_J=-40^{\circ}C$ to $+125^{\circ}C$	1970	2000	2030	
PFET switch on resistance	R_{DSON_P}	$V_{IN}=5V$		75		m Ω
NFET switch on resistance	R_{DSON_N}	$V_{IN}=5V$		45		m Ω
Switch leakage		$V_{EN} = 0V$, $V_{IN} = 6V$, $V_{SW} = 0V$ and $6V$, $T_J=25^{\circ}C$		0	1	μ A
PFET peak current limit			2.8		4	A
NFET valley current limit				2.5		A
ZCD				50		mA
ON time	T_{ON}	$V_{IN}=5V$, $V_{OUT}=1.2V$	180	220	260	ns
		$V_{IN}=3.6V$, $V_{OUT}=1.2V$	240	300	360	
Switching frequency	f_s	$V_{OUT}=1.2V$		1100		kHz
Minimum off time	$T_{MIN-OFF}$			100		ns
Minimum on time ⁽⁷⁾	T_{MIN-ON}			60		ns
Soft-start time	T_{SS-ON}			0.5		ms
Maximum duty cycle			100			%
Power good rising threshold UV		V_o rising edge		90		%
Power good falling threshold UV		V_o falling edge		85		%

ELECTRICAL CHARACTERISTICS (continued)

$V_{IN} = 3.6V$, $T_J = -40^{\circ}C$ to $+125^{\circ}C$ ⁽⁶⁾, Typical value is tested at $T_J = +25^{\circ}C$. The limit over temperature is guaranteed by characterization, unless otherwise noted.

Parameter	Symbol	Condition	Min	Typ	Max	Units
Power good rising threshold OV		Vo rising edge		115		%
Power good falling threshold OV		Vo falling edge		105		%
Power good delay	PG _D	PG rising/falling edge		150		μ s
Power good sink current capability	V _{PG-L}	Sink 1mA			0.4	V
Power good logic high voltage	V _{PG-H}	V _{IN} =5V, V _O = Fixed OUT	4.9			V
EN turn-on delay		EN on to SW active		150		us
EN input logic low voltage					0.4	V
EN input logic high voltage			1.2			V
Output discharge resistor	R _{DIS}	V _{EN} =0V, V _{OUT} =1.2V		200		Ω
EN input current		V _{EN} =2V		1.2		μ A
		V _{EN} =0V		0		μ A
Supply current (shutdown)		V _{EN} =0V		0	1	μ A
Supply current (quiescent)		V _{EN} =2V, V _{out} = Fixed OUT + 0.03V, V _{IN} =5V, T _J =25 $^{\circ}$ C		30	35	μ A
Output over-voltage threshold	V _{OVP}		110%	115%	120%	V _O
Vo OVP hysteresis	V _{OVP_HYS}			10%		V _O
OVP delay				12		μ s
Low-side current ⁽⁷⁾		Current flow from GND to SW		1.5		A
Absolute VIN OVP		After Vo OVP enable		6.1		V
Absolute VIN OVP hysteresis				400		mV
Thermal shutdown ⁽⁷⁾				160		$^{\circ}$ C
Thermal hysteresis ⁽⁷⁾				30		$^{\circ}$ C

Notes:

- 6) Not tested in production. Guaranteed by over-temperature correlation.
 7) Guaranteed by engineering sample characterization.

TYPICAL CHARACTERISTICS

$V_{IN} = 3.6V$, $V_{OUT} = 1.2V$, $L = 1\mu H$, $C_{OUT} = 22\mu F$, $T_A = +25^\circ C$, unless otherwise noted.

Quiescent Current vs. Input Voltage

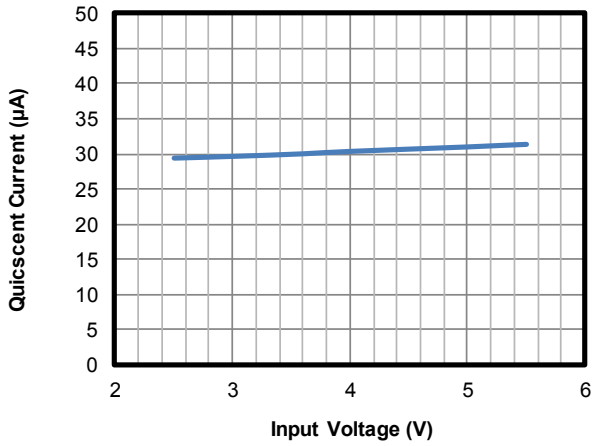

Shutdown Current vs. Input Voltage

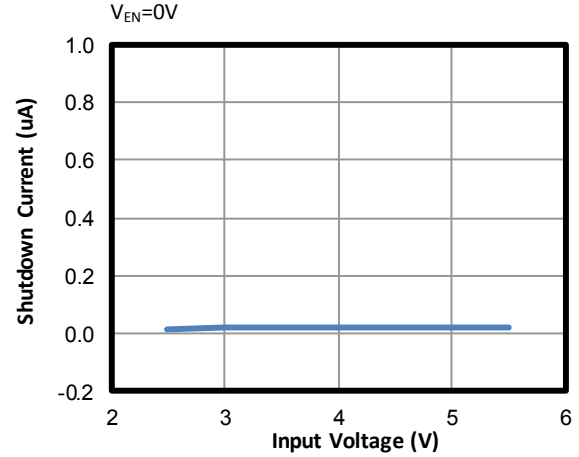

Load Regulation

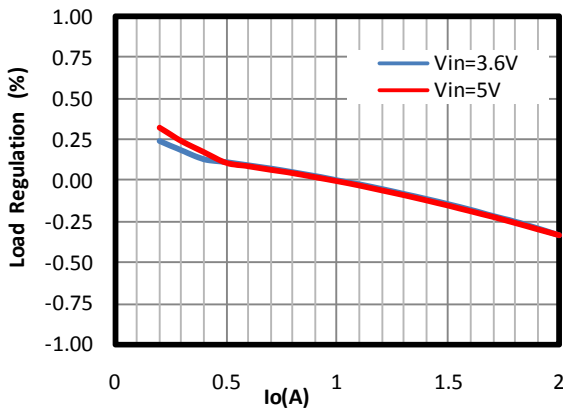

Line Regulation

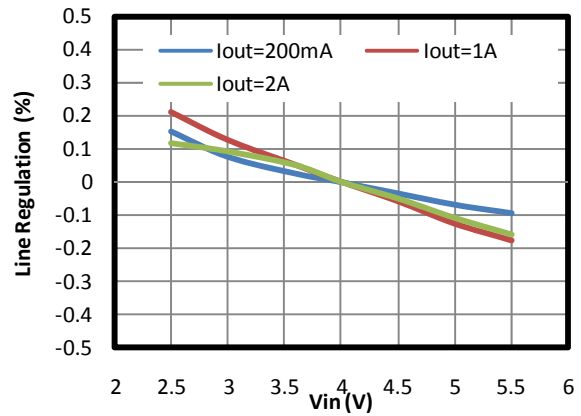

Case Temperature Rise vs. Output Current

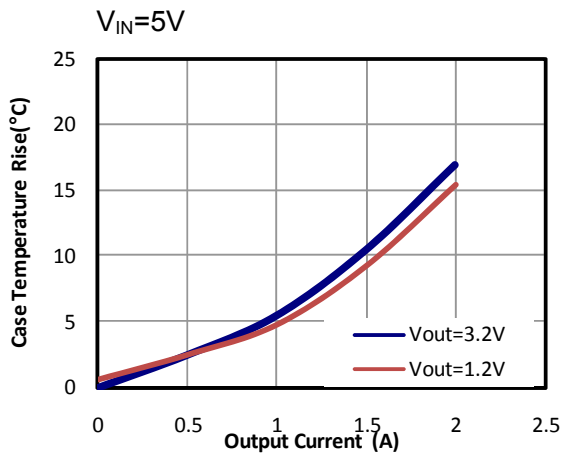

Efficiency vs. Output Current

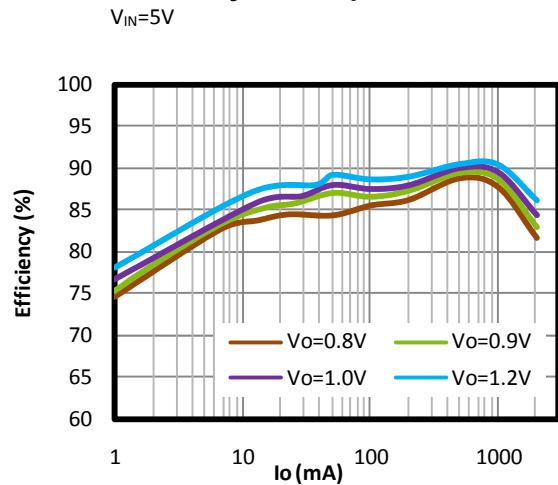

TYPICAL CHARACTERISTICS

$V_{IN} = 3.6V$, $V_{OUT} = 1.2V$, $L = 1\mu H$, $C_{OUT} = 22\mu F$, $T_A = +25^\circ C$, unless otherwise noted.

Efficiency vs. Output Current

$V_{IN} = 5V$

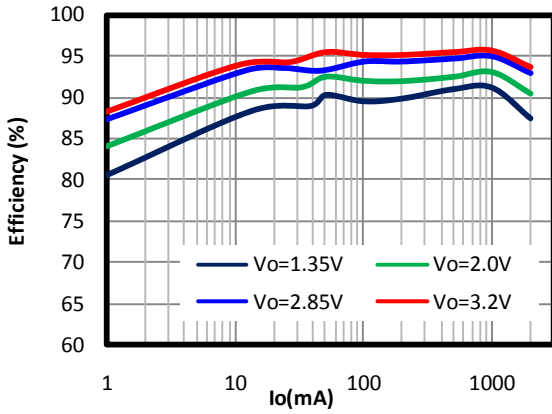

Efficiency vs. Output Current

$V_{IN} = 3.6V$

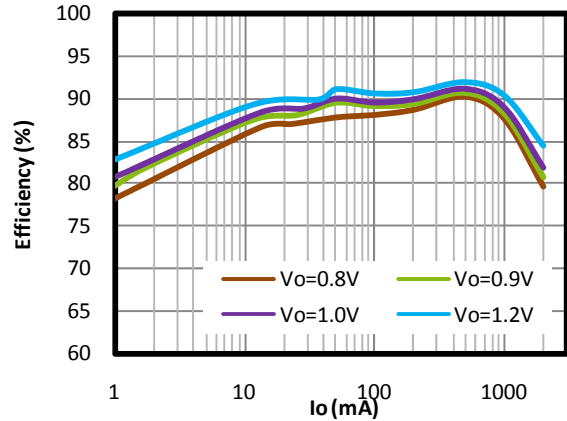

Efficiency vs. Output Current

$V_{IN} = 3.6V$

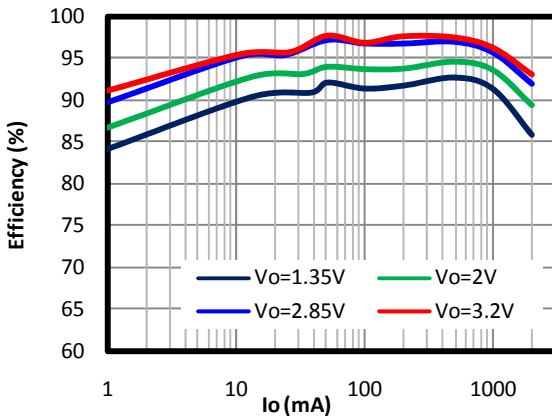

Quiescent Current vs. Temperature

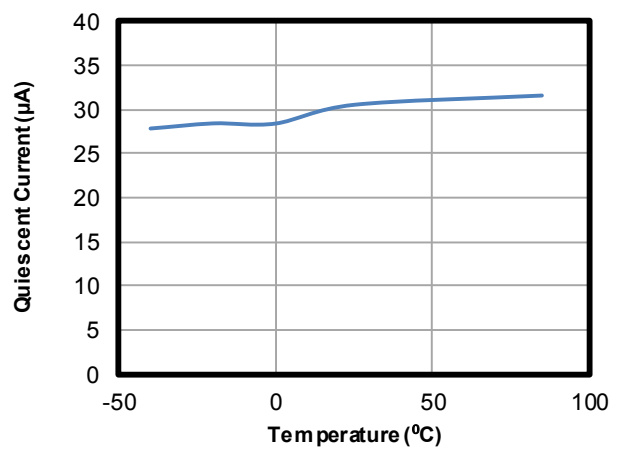

EN Rising and Falling Threshold vs. Temperature

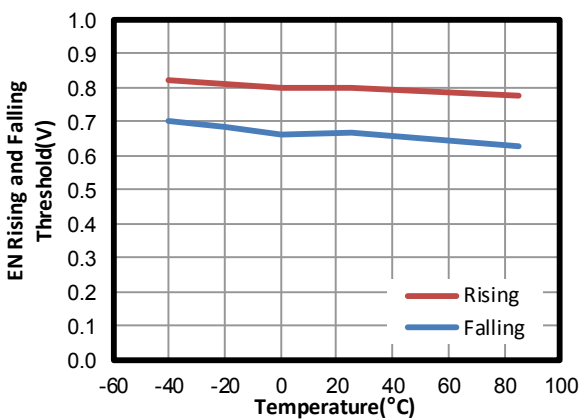

V_{IN} Rising and Falling Threshold vs. Temperature

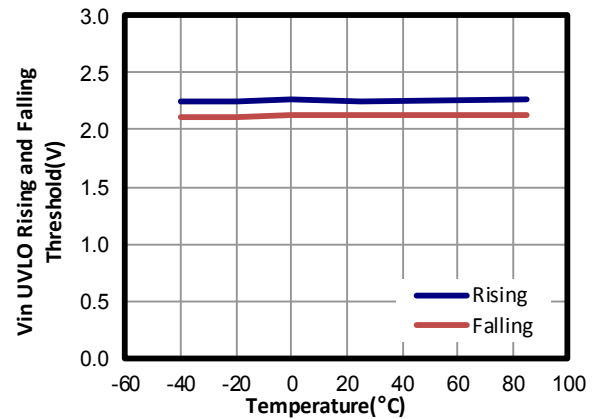

TYPICAL CHARACTERISTICS

$V_{IN} = 3.6V$, $V_{OUT} = 1.2V$, $L = 1\mu H$, $C_{OUT} = 22\mu F$, $T_A = +25^\circ C$, unless otherwise noted.

V_{IN} OVP Rising and Falling Threshold vs. Temperature

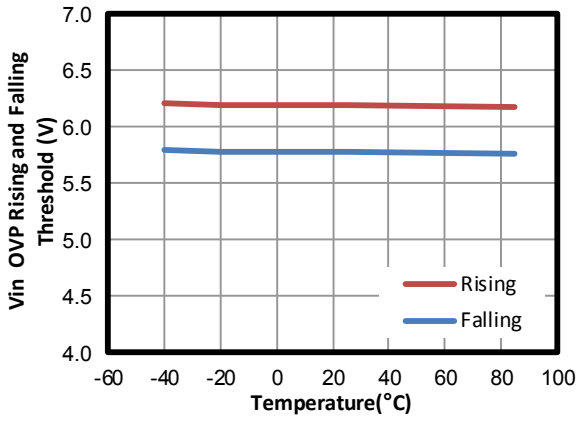

Output Current Derating vs. Ambient Temperature

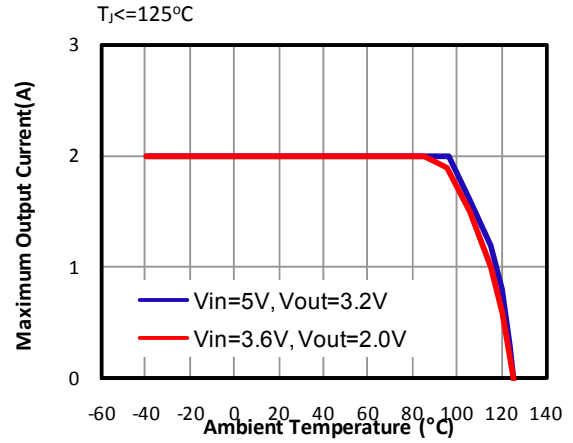

Output Current Derating vs. Output Voltage

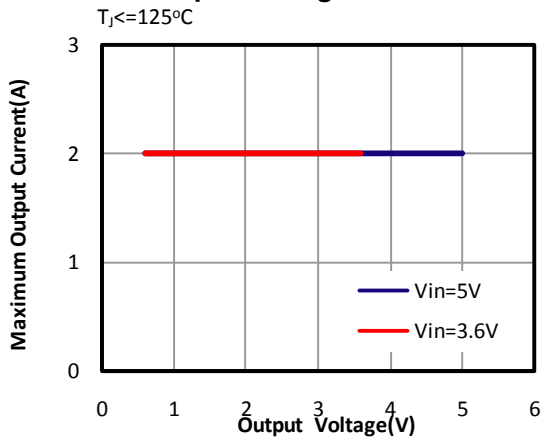

TYPICAL PERFORMANCE CHARACTERISTICS

$V_{IN} = 5V$, $V_{OUT} = 1.2V$, $L = 1\mu H$, $C_{OUT} = 22\mu F$, $T_A = +25^\circ C$, unless otherwise noted.

Steady State

$I_{OUT} = 0A$

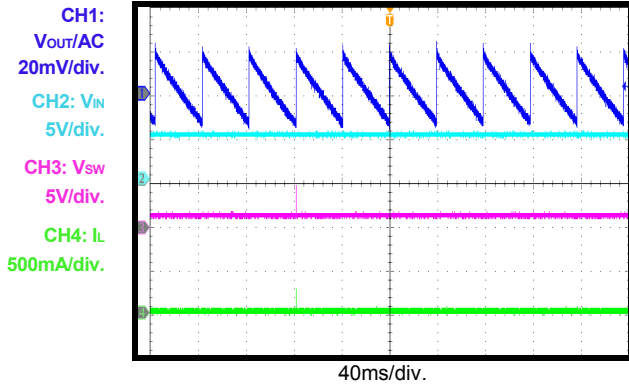

Steady State

$I_{OUT} = 2A$

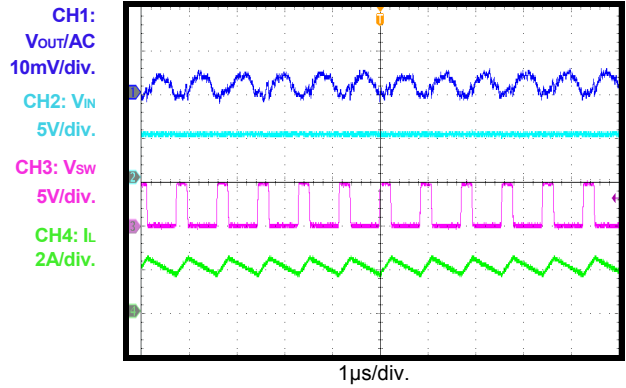

V_{IN} Power-Up

$I_{OUT} = 0A$

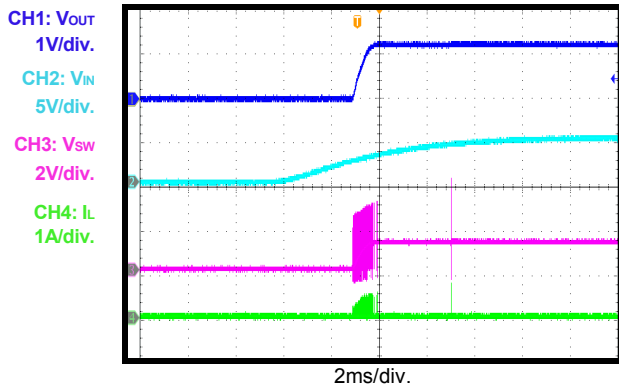

V_{IN} Power-Up

$I_{OUT} = 2A$

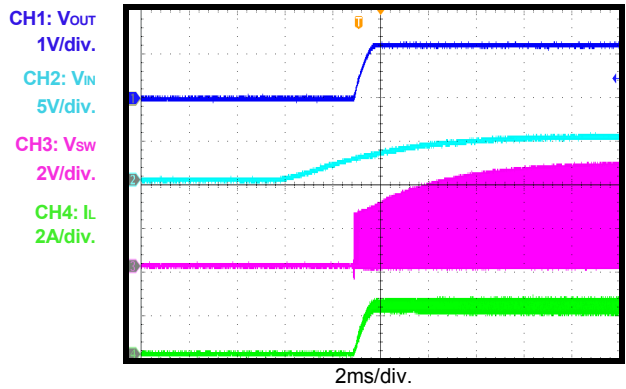

V_{IN} Shutdown

$I_{OUT} = 0A$

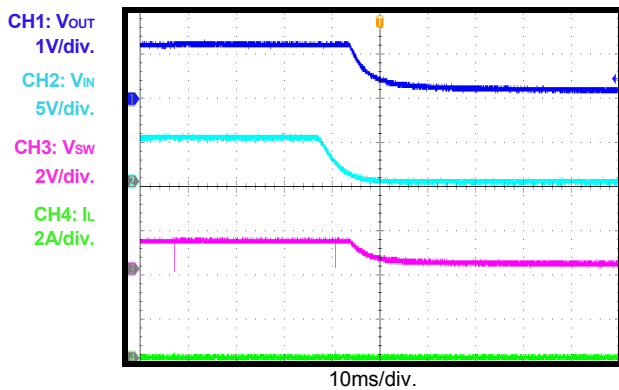

V_{IN} Shutdown

$I_{OUT} = 2A$

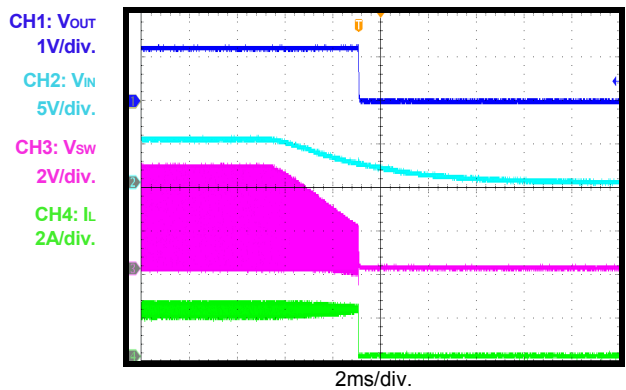

TYPICAL PERFORMANCE CHARACTERISTICS *(continued)*

$V_{IN}=5V$, $V_{OUT}=1.2V$, $L=1\mu H$, $C_{OUT}=22\mu F$, $T_A = +25^\circ C$, unless otherwise noted.

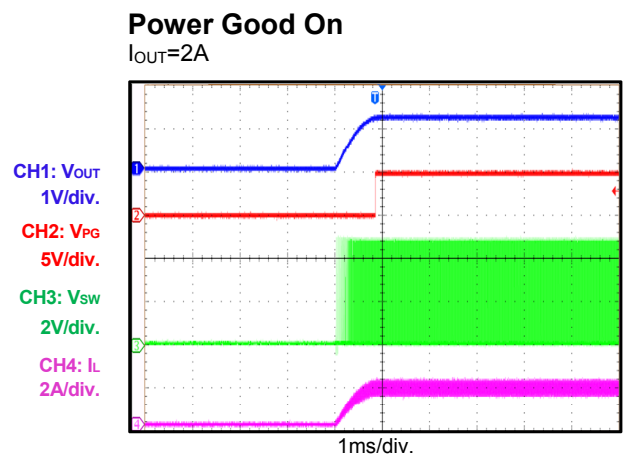
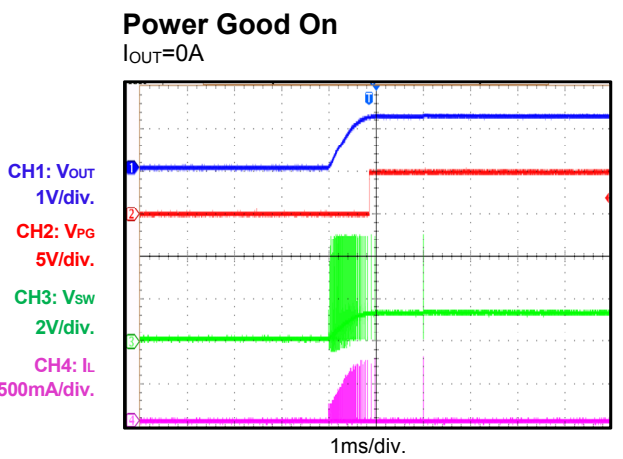
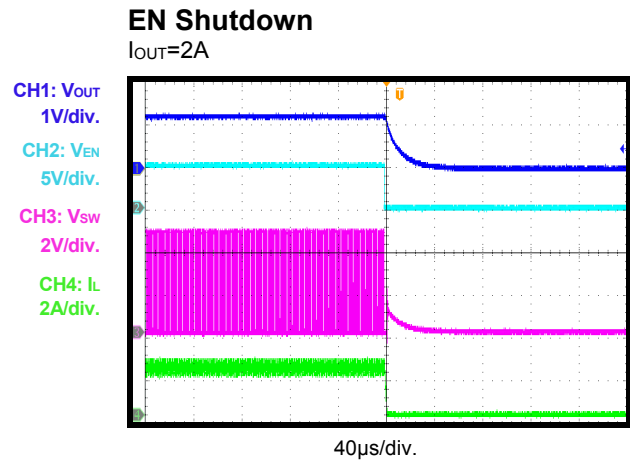
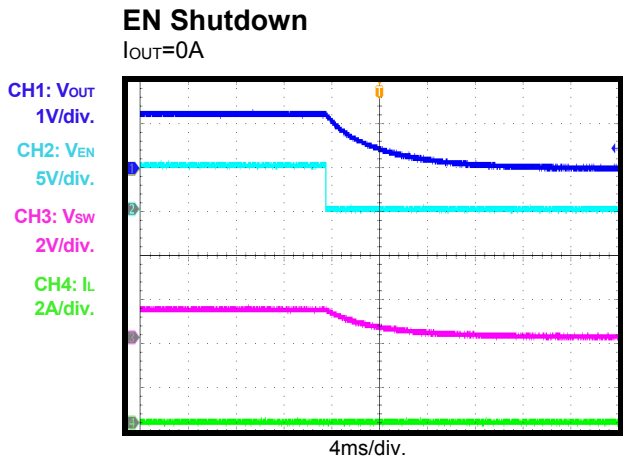
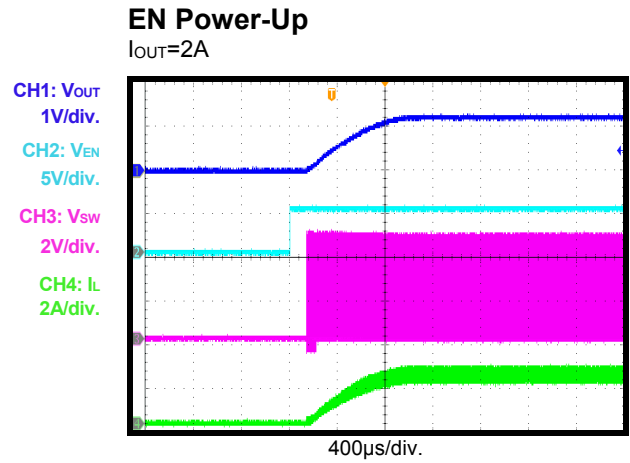
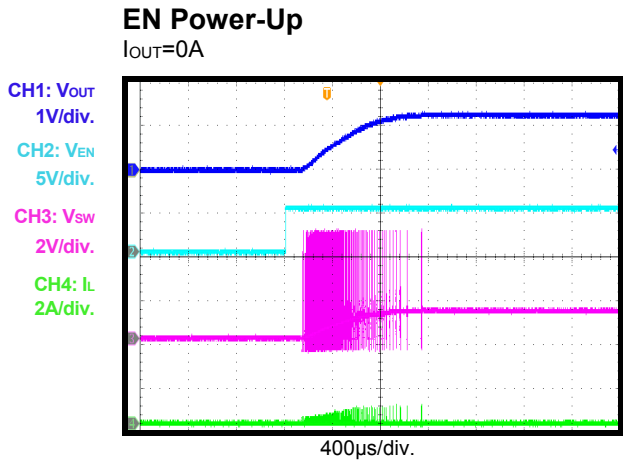

TYPICAL PERFORMANCE CHARACTERISTICS (continued)

$V_{IN}=5V$, $V_{OUT}=1.2V$, $L=1\mu H$, $C_{OUT}=22\mu F$, $T_A = +25^\circ C$, unless otherwise noted.

Power Good Off

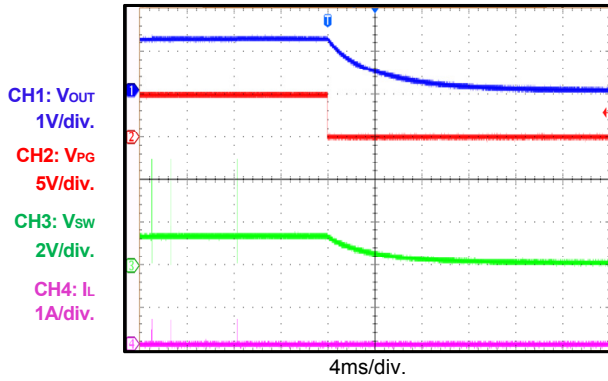

Power Good Off

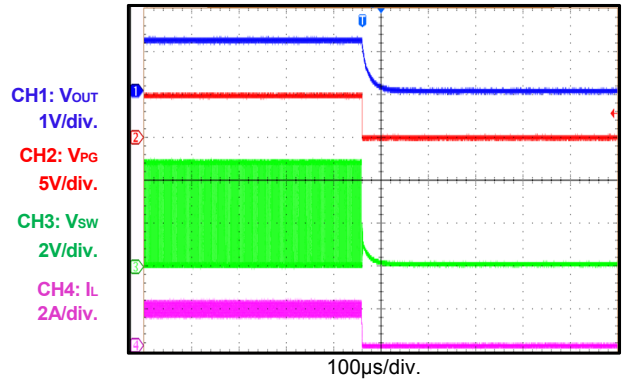

Load Transient

$I_{OUT}=0A-1A$

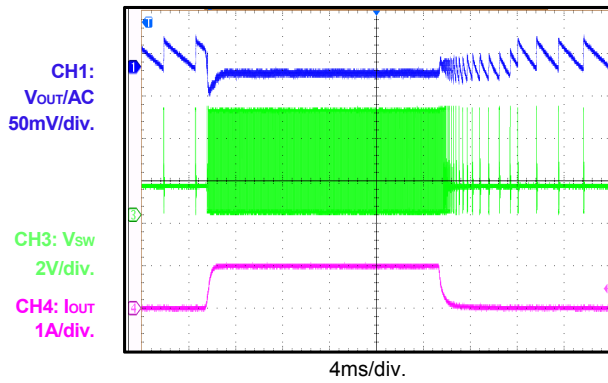

Load Transient

$I_{OUT}=0.1A-2A$, 1A/ μ s

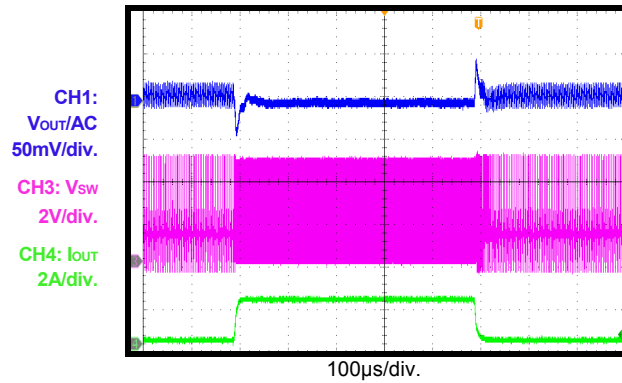

Short-Circuit Entry

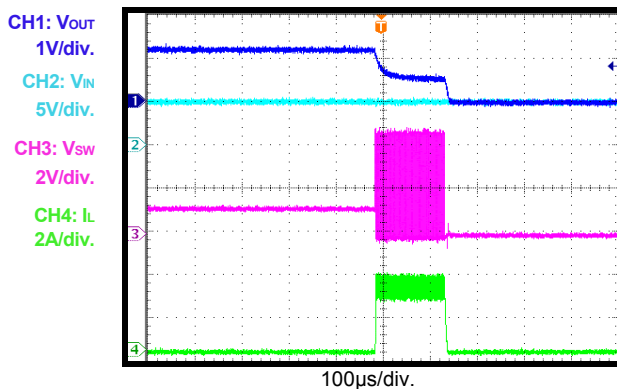

Short-Circuit State

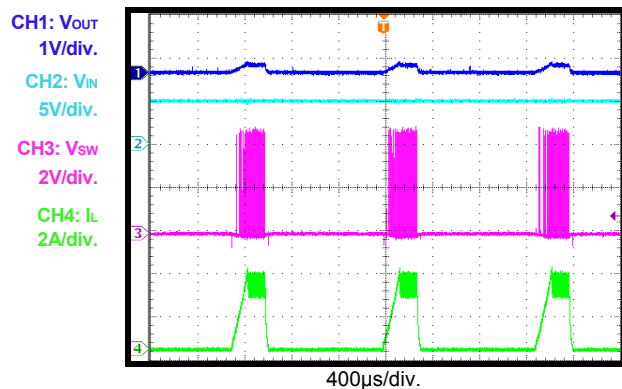

TYPICAL PERFORMANCE CHARACTERISTICS *(continued)*

$V_{IN} = 5V$, $V_{OUT} = 1.2V$, $L = 1\mu H$, $C_{OUT} = 22\mu F$, $T_A = +25^\circ C$, unless otherwise noted.

Short-Circuit Recovery

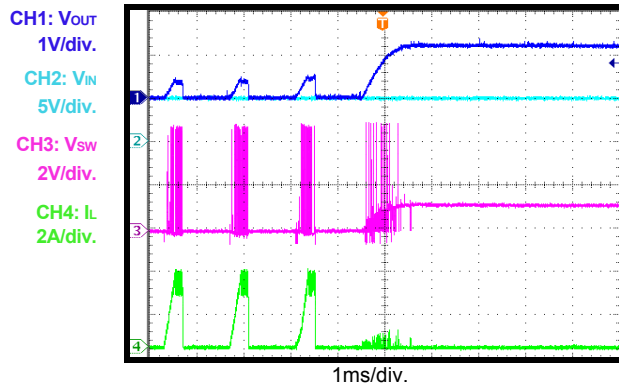

BLOCK DIAGRAM

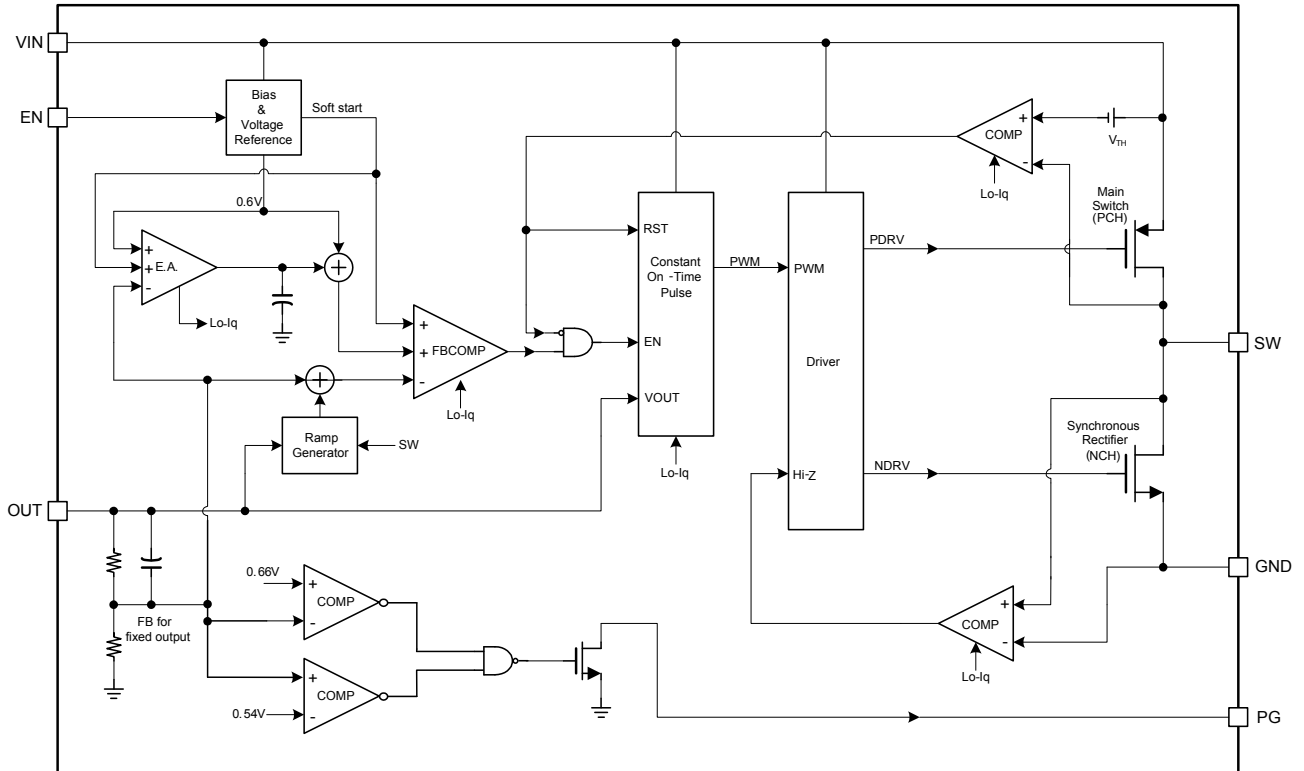

Figure 1: Functional Block Diagram

OPERATION

The MP1606 uses constant-on-time (COT) control with input voltage feed forward to stabilize the switching frequency over the full input range. It achieves 2A continuous output current from a 2.5V to 5.5V input voltage with excellent load and line regulation. The MP1606 provides different fixed output voltages with PG functionality.

Constant-On-Time (COT) Control

Compared to fixed frequency PWM control, constant-on-time (COT) control offers a simpler control loop and a faster transient response. By using input voltage feed forward, the MP1606 maintains a nearly constant switching frequency across the input and output voltage ranges. The switching pulse on time can be estimated using equation (1):

$$T_{ON} = \frac{V_{OUT}}{V_{IN}} \cdot 0.91\mu s \quad (1)$$

To prevent inductor current runaway during load transient, the MP1606 has a fixed minimum off time of 100ns.

Sleep Mode Operation

The MP1606 features sleep mode to get high efficiency at extreme light load. In sleep mode, most of the circuit blocks are turned off, except the error amplifier and PWM comparator, thus the operation current is reduced to a minimal value (see Figure 2).

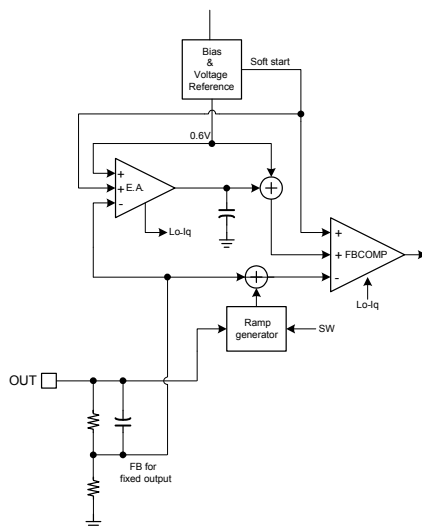

Figure 2: Operation Blocks at Sleep Mode

When the load gets lighter, the ripple of the output voltage increases and it drives the error amplifier output (EAO) lower. When the EAO hits an internal low threshold, it is clamped at that level, and the MP1606 enters sleep mode. In sleep mode, the valley of the FB voltage is regulated to the internal reference voltage, thus, the average output voltage is slightly higher than the output voltage at DCM or CCM. The on-time pulse at sleep mode is a little larger than that on DCM or CCM. Figure 3 shows the average FB voltage relationship with the internal reference at sleep mode.

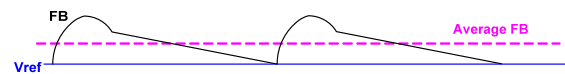

Figure 3: FB Average Voltage at Sleep Mode

When the MP1606 is in sleep mode, the average output voltage is higher than the internal reference voltage. The EAO is kept low and clamped in sleep mode. When the load increases, the PWM switching period decreases in order to keep the output voltage regulated; the output voltage ripple decreases relatively. Once the EAO rises above the internal low threshold, the MP1606 exits sleep mode and enters DCM or CCM, depending on the load. In DCM or CCM, the EA regulates the average output voltage to the internal reference (see Figure 4).

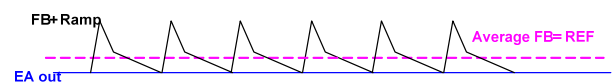

Figure 4: DCM Mode Control

There is always a loading hysteresis when entering and exiting sleep mode due to the error amplifier clamping response time.

AAM Operation at Light-Load Operation

The MP1606 has advanced asynchronous modulation (AAM) power-save mode (see Figure 5) and a zero current cross detection (ZCD) circuit for light load.

The AAM current (I_{AAM}) is set internally. The SW on pulse time is decided by an on-timer generator and AAM comparator. In a light-load condition, the SW on pulse time is the longer one. See Figure 6 when the AAM comparator pulse is longer than the on-timer generator.

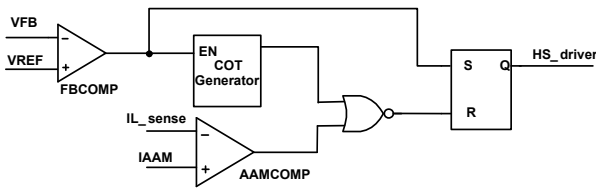

Figure 5: Simplified AAM Control Logic

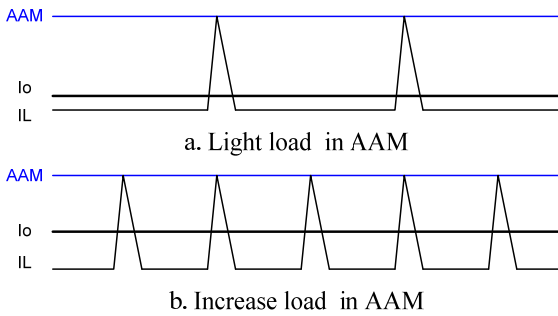

Figure 6: AAM Comparator Control Ton

See Figure 7 when the AAM comparator pulse is shorter than the on-timer generator. Generally, very low inductance may create this condition.

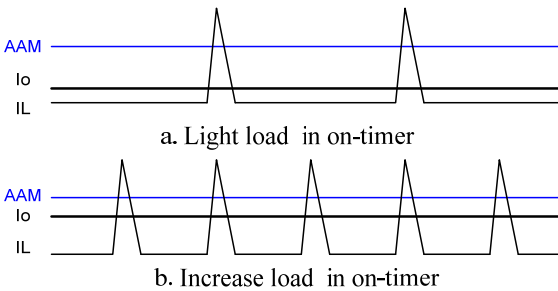

Figure 7: On-Timer Control Ton

Figure 8 shows when the AAM threshold decreases as T_{ON} increases gradually. For the CCM state, I_O needs to be more than half of the AAM threshold.

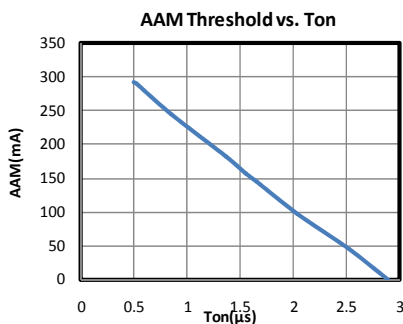

Figure 8: AAM Threshold Decreases as T_{ON} Increases.

The MP1606 has a zero current cross detect circuit (ZCD) to determine if the inductor current starts to reverse. When the inductor current reaches the ZCD threshold, the low-side switch will be turned off.

The AAM mode and ZCD circuit allow the MP1606 to always work in DCM mode at light load, even if V_{OUT} is closed to V_{in} .

Enable

When the input voltage is greater than the under-voltage lockout threshold (UVLO), typically 2.3V, the MP1606 can be enabled by pulling the EN pin to higher than 1.2V. Leaving the EN pin floating or pulled down to ground will disable the MP1606. There is an internal 1M Ω resistor from EN to ground.

When the device is disabled, the part goes into output discharge mode automatically, and its internal discharge MOSFET provides a resistive discharge path for the output capacitor.

Soft Start

The MP1606 has a built-in soft start that ramps up the output voltage at a controlled slew rate to avoid overshoot at start-up. The soft-start time is about 0.5ms, typically.

Current limit

The MP1606 has a minimum 2.8A high-side switch current limit, typically. When the high-side switch hits its current limit, the MP1606 will remain in hiccup mode until the current drops. This prevents the inductor current from continuing to rise and damaging components.

Short Circuit and Recovery

The MP1606 will enter short-circuit protection mode when it hits the current limit and tries to recover with hiccup mode: The MP1606 will disable the output power stage, discharge the soft-start capacitor, and then automatically soft start again. If the short-circuit condition remains after the soft start ends, the MP1606 repeats this cycle until the short circuit disappears and the output rises back to regulation level.

Over-Voltage Protection (Vo OVP)

The MP1606 monitors a resistor divided feedback voltage to detect over voltage. When the feedback voltage rises above 115% of the target voltage, the controller will enter a dynamic regulation period. During this period, the LS is on until the LS current hits -1.5A, this will discharge the output and try to keep it within the normal range. If OV still exists, the LS will turn on again after a 1 μ S time delay. The device will exit this regulation

period when the feedback voltage drops below 105% of the reference voltage. If the dynamic regulation cannot limit the V_{OUT} increasing, once the input detects the 6.1V, it will trigger the input OVP. The MP1606 will stop switching until the input voltage drops below 5.7V, then the MP1606 will begin to operate again.

Power Good Indicator (only for MP1606GTF-XX)

The MP1606GTF-XX has an open-drain output and requires an external pull-up resistor (100~500k Ω) for the power good indicator. When the V_{FB} is within -10%/+15% of the regulation voltage, the V_{PG} is pulled up to V_{OUT}/V_{IN} by the external resistor. If V_{FB} exceeds this window, the internal MOSFET pulls PG to ground. The MOSFET has a maximum $R_{DS(ON)}$ of less than 400 Ω .

APPLICATION INFORMATION

OTHER VOUT APPLICATION

The MP1606-XX Fixed V_{OUT} is decided by the internal feedback divider (see Table 1).

Table 1: MP1606-XX Internal Feedback Divider

Fixed Vout(V) MP1606-XX	IC_R1(KΩ)	IC_R2(KΩ)
0.80	100	300
0.90	150	300
1.00	200	300
1.20	300	300
1.35	250	200
2.00	280	120
2.85	300	80
3.20	260	60

If an additional V_{OUT} value is needed, the MP1606-XX can set up the V_{OUT} by the external divider resistors in two ways:

1. Choose the IC and the output is close to the expectation V_{OUT} .
2. Design the external divider. The R4 value should not be too large to achieve noise immunity. Typically less than 40KΩ is recommended.

The external divider can be estimated using equation (2).

$$\frac{V_{OUT} - V_{FIX}}{R3} = \frac{V_{FIX}}{R4} + \frac{V_{FIX}}{(IC_R1 + IC_R2)} \quad (2)$$

Where V_{FIX} is the output voltage of the Fixed version IC. IC_R1 and IC_R2 are the internal feedback divider. See Figure 9 for a 1.1V V_{OUT} application.

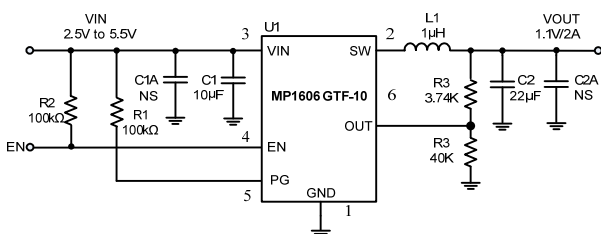

Figure 9: Other VOUT Application Circuit for MP1606-XX

COMPONENT SELECTION

Selecting the Inductor

For most applications, the MP1606 works best with a 1μH to 2.2μH inductor. Select an inductor with a DC resistance less than 50mΩ to optimize efficiency.

High frequency switch mode power supplies with magnetic devices create strong electronic magnetic inference for the system. Avoid any un-shielded power inductors. Shielding the inductors with metal alloy or a multilayer chip can decrease the interference effectively (see Table 2).

Table 2: Suggested Inductor List

Manufacturer P/N	Inductance(μH)	Manufacturer
PIFE25201B-1R0MS	1.0	CYNTEC CO. LTD.
74438322010	1.0	Würth

For most designs, estimate the inductance value using equation (3).

$$L_1 = \frac{V_{OUT} \times (V_{IN} - V_{OUT})}{V_{IN} \times \Delta I_L \times f_{OSC}} \quad (3)$$

Where ΔI_L is the inductor ripple current.

Choose an inductor current to be approximately 30% of the maximum load current. The maximum inductor peak current is calculated using equation (4):

$$I_{L(MAX)} = I_{LOAD} + \frac{\Delta I_L}{2} \quad (4)$$

Selecting the Input Capacitor

The input current to the step-down converter is discontinuous, and therefore requires a capacitor to supply the AC current to the step-down converter while maintaining the DC input voltage. Use low ESR capacitors for the best performance. Ceramic capacitors with X5R or X7R dielectrics are highly recommended because of their low ESR and small temperature coefficients. For most applications, a 10μF capacitor is sufficient. Higher output voltages may require a 22μF capacitor to increase system stability.

The input capacitor requires an adequate ripple current rating because it absorbs the input

switching current. Estimate the RMS current in the input capacitor with equation (5):

$$I_{C1} = I_{LOAD} \times \sqrt{\frac{V_{OUT}}{V_{IN}} \times \left(1 - \frac{V_{OUT}}{V_{IN}}\right)} \quad (5)$$

The worst case occurs at $V_{IN} = 2V_{OUT}$, where:

$$I_{C1} = \frac{I_{LOAD}}{2}$$

For simplification, choose an input capacitor with an RMS current rating greater than half of the maximum load current.

The input capacitor can be electrolytic, tantalum or ceramic. When using electrolytic or tantalum capacitors, add a small, high quality ceramic 0.1μF capacitor as close to the IC as possible. When using ceramic capacitors, make sure that they have enough capacitance to provide sufficient charge to prevent excessive voltage ripple at the input. The input voltage ripple caused by capacitance can be estimated with equation (6):

$$\Delta V_{IN} = \frac{I_{LOAD}}{f_s \times C1} \times \frac{V_{OUT}}{V_{IN}} \times \left(1 - \frac{V_{OUT}}{V_{IN}}\right) \quad (6)$$

Selecting the Output Capacitor

The output capacitor (C2) stabilizes the DC output voltage. Ceramic capacitors are recommended. Low ESR capacitors are preferred to limit the output voltage ripple. Estimate the output voltage ripple with equation (7):

$$\Delta V_{OUT} = \frac{V_{OUT}}{f_s \times L_1} \times \left(1 - \frac{V_{OUT}}{V_{IN}}\right) \times \left(R_{ESR} + \frac{1}{8 \times f_s \times C2}\right) \quad (7)$$

Where L_1 is the inductor value and R_{ESR} is the equivalent series resistance (ESR) value of the output capacitor.

When using ceramic capacitors, the capacitance dominates the impedance at the switching frequency and causes most of the output voltage ripple. For simplification, the output voltage ripple can be estimated with equation (8):

$$\Delta V_{OUT} = \frac{V_{OUT}}{8 \times f_s^2 \times L_1 \times C2} \times \left(1 - \frac{V_{OUT}}{V_{IN}}\right) \quad (8)$$

For tantalum or electrolytic capacitors, the ESR dominates the impedance at the switching

frequency. For simplification, the output ripple can be approximated with equation (9):

$$\Delta V_{OUT} = \frac{V_{OUT}}{f_s \times L_1} \times \left(1 - \frac{V_{OUT}}{V_{IN}}\right) \times R_{ESR} \quad (9)$$

The characteristics of the output capacitor also affect the stability of the regulation system. For output ripple and system stability, a 22μF output ceramic capacitor works for most applications.

PCB Layout

Efficient PCB layout is critical for stable operation. A poor layout can result in line or load regulation and stability issues. For best results, refer to Figure 10 and follow the guidelines below.

1. Place the high-current paths (GND, V_{in} and SW) very close to the device with short, direct and wide traces.
2. Place input capacitor needs as close as possible to the V_{in} and GND pins.
3. Keep the V_{out} sense line as short as possible or keep it away from the power inductor.

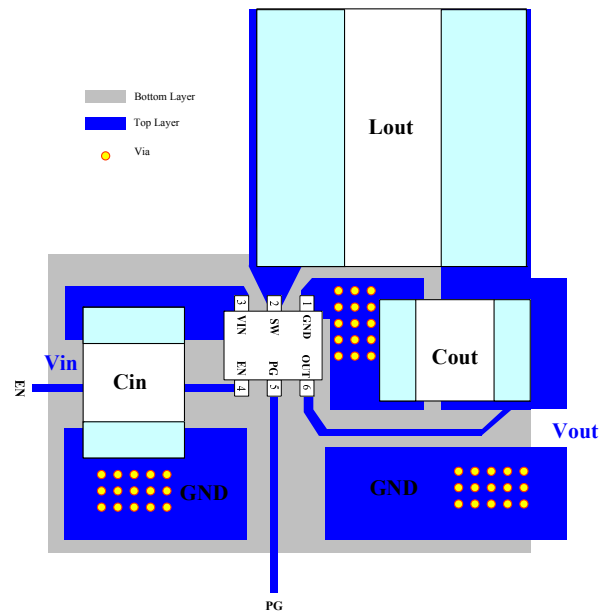

Figure 10: PCB layout

TYPICAL APPLICATION CIRCUITS

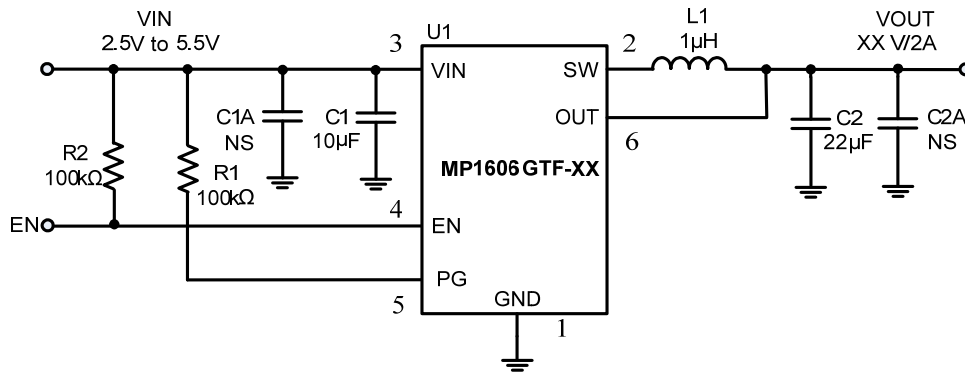
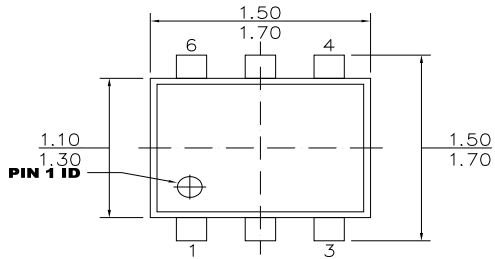

Figure 11: Typical Application Circuit for MP1606-XX

Note: $V_{IN} < 3.3V$ may need more input capacitors; V_{IN} is larger than V_{OUT} .

PACKAGE INFORMATION

SOT563



TOP VIEW

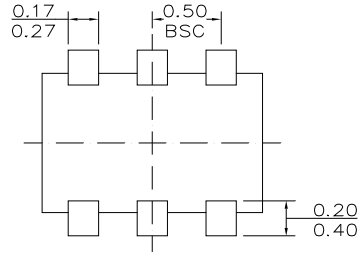

BOTTOM VIEW



FRONT VIEW

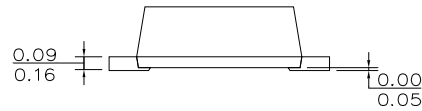

SIDE VIEW

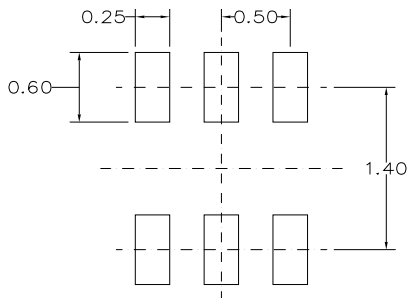

RECOMMENDED LAND PATTERN

NOTE:

- 1) ALL DIMENSIONS ARE IN MILLIMETERS.
- 2) PACKAGE LENGTH DOES NOT INCLUDE MOLD FLASH, PROTRUSION OR GATE BURR.
- 3) PACKAGE WIDTH DOES NOT INCLUDE INTERLEAD FLASH OR PROTRUSION.
- 4) LEAD COPLANARITY (BOTTOM OF LEADS AFTER FORMING) SHALL BE 0.10 MILLIMETERS MAX.
- 5) DRAWING IS NOT TO SCALE.



Revision History

Revision #	Revision Date	Description	Pages Updated
1.01	10/10/2020	Delete these two options: the MP1606GTF-285 and MP1606GTF-32	P2, P6

NOTICE: The information in this document is subject to change without notice. Users should warrant and guarantee that third party Intellectual Property rights are not infringed upon when integrating MPS products into any application. MPS will not assume any legal responsibility for any said applications.