

DESCRIPTION

The MP2192C is a monolithic, step-down, switch-mode converter with built-in internal power MOSFETs. It can achieve up to 2A of continuous output current (I_{OUT}) from a 2.5V to 5.5V input voltage (V_{IN}) range, with excellent load and line regulation. The output voltage (V_{OUT}) can be regulated to as low as 0.6V.

The constant-on-time (COT) control scheme provides fast transient response and eases loop stabilization. Fault protections include cycle-by-cycle current limiting and thermal shutdown.

The MP2192C is ideal for a wide range of applications, including high-performance DSPs, wireless power, portable and mobile devices, and other low-power systems.

The MP2192C is available in an ultra-small WLCSP (0.85mmx1.25mm) package, and requires a minimal number of readily available standard, external components.

FEATURES

- Forced Pulse-Width Modulation (PWM) Mode Operation
- 1.1MHz Switching Frequency (f_{sw})
- EN for Power Sequencing
- 1% FB Accuracy
- Wide 2.5V to 5.5V Operating Input Voltage (V_{IN}) Range
- Output Adjustable from 0.6V
- Up to 2A Output Current (I_{OUT})
- 75m Ω and 45m Ω Internal Power MOSFETs
- 100% Duty On
- Output Discharge
- Output Voltage (V_{OUT}) Over-Voltage Protection (OVP)
- Short-Circuit Protection (SCP) with Hiccup Mode
- Available in a 6-Ball WLCSP (0.85mmx1.25mm) Package



Optimized Performance with
MPS Inductor MPL-AL4020 Series

APPLICATIONS

- Wireless/Networking Cards
- Portable Instruments
- Battery-Powered Devices
- Low-Voltage I/O System Power
- Multi-Function Printers

All MPS parts are lead-free, halogen-free, and adhere to the RoHS directive. For MPS green status, please visit the MPS website under Quality Assurance. "MPS", the MPS logo, and "Simple, Easy Solutions" are trademarks of Monolithic Power Systems, Inc. or its subsidiaries.

TYPICAL APPLICATION

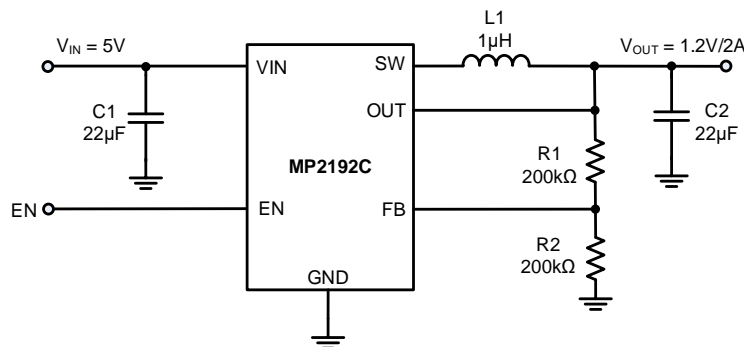

Efficiency vs. Output Current

$V_{IN} = 5V$, $L = 1\mu H$ (DCR = 10.1m Ω)

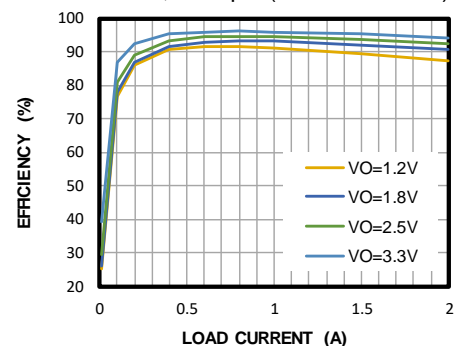

ORDERING INFORMATION

Part Number*	Package	Top Marking	V _{OUT} Range	MSL Rating
MP2192CGC	WLCSP-6 (0.85mmx1.25mm)	See Below	Adjustable	1

* For Tape & Reel, add suffix -Z (e.g. MP2192CGC-Z).

TOP MARKING

KBY
LLL

KB: Product code of MP2192CGC
 Y: Year code
 LLL: Lot number

PACKAGE REFERENCE

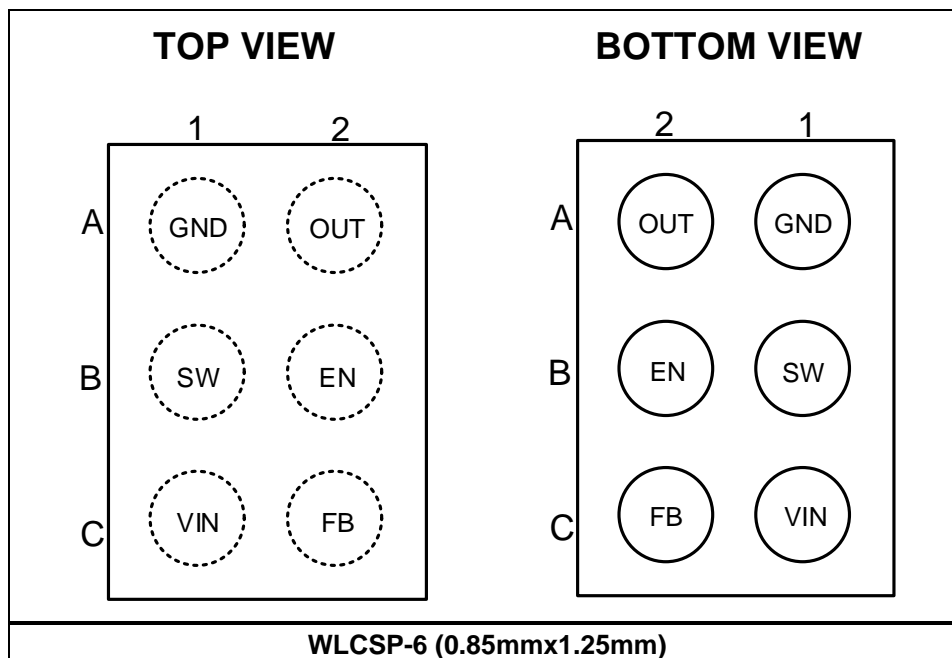

PIN FUNCTIONS

Pin #	Pin Name	Description
A1	GND	Power ground.
A2	OUT	Output sense. The OUT pin is the voltage power rail and input sense pin for the output voltage (V_{OUT}). An output capacitor (C_{OUT}) is required to decrease the V_{OUT} ripple.
B1	SW	Output switching node. The SW pin is the drain of the internal high-side P-channel MOSFET. Connect the inductor to SW to complete the converter.
B2	EN	On/off control.
C1	VIN	Supply voltage. The MP2192C operates from a 2.5V to 5.5V unregulated input voltage (V_{IN}). A decoupling capacitor is required to prevent large voltage spikes from appearing at the input.
C2	FB	Feedback. An external resistor divider from the output to GND tapped to the FB pin sets V_{OUT} .

ABSOLUTE MAXIMUM RATINGS ⁽¹⁾

Supply voltage (V_{IN})	6.5V
Switching voltage (V_{SW})	
-0.3V (-5V for <10ns) to +6.5V (10V for <10ns)	
All other pins	-0.3V to +6.5V
Junction temperature	150°C
Lead temperature	260°C
Continuous power dissipation ($T_A = 25^\circ\text{C}$) ^{(2) (4)}	
.....	1.39W
Storage temperature	-65°C to +150°C

ESD Ratings

Human body model (HBM)	±2000V
Charged device model (CDM) ..	+1000V, -1500V

Recommended Operating Conditions ⁽³⁾

Supply voltage (V_{IN})	2.5V to 5.5V
Operating junction temp (T_J)	-40°C to +125°C

Thermal Resistance	θ_{JA} ⁽⁶⁾	θ_{JC} (TOP)
EVL2192C-C-00A ⁽⁴⁾	90	30
WLCSP6 ⁽⁶⁾	141	2

Notes:

- Exceeding these ratings may damage the device.
- The maximum allowable power dissipation is a function of the maximum junction temperature T_J (MAX), the junction-to-ambient thermal resistance θ_{JA} , and the ambient temperature T_A . The maximum allowable continuous power dissipation at any ambient temperature is calculated by P_D (MAX) = $(T_J$ (MAX) - T_A) / θ_{JA} . Exceeding the maximum allowable power dissipation can cause excessive die temperature, and the regulator may go into thermal shutdown. Internal thermal shutdown circuitry protects the device from permanent damage.
- The device is not guaranteed to function outside of its operating conditions.
- Measured on EVL2192C-C-00A demo board, 2-layer PCB.
- Measured on JESD51-7, 4-layer PCB.
- The value of θ_{JA} given in this table is only valid for comparison with other packages and cannot be used for design purposes. These values are calculated in accordance with JESD51-7, and simulated on a specified JEDEC board. They do not represent the performance obtained in an actual application.

ELECTRICAL CHARACTERISTICS

$V_{IN} = 3.6V$, $T_J = -40^{\circ}C$ to $+125^{\circ}C$ ⁽⁷⁾, typical value is tested at $T_J = 25^{\circ}C$, over-temperature limit is guaranteed by characterization, unless otherwise noted.

Parameter	Symbol	Condition	Min	Typ	Max	Units
Input voltage (V_{IN}) range			2.5		5.5	V
Under-voltage lockout (UVLO) rising threshold				2.3	2.45	V
UVLO threshold hysteresis				135		mV
Feedback (FB) voltage	V_{FB}	$T_J = 25^{\circ}C$, $2.5V \leq V_{IN} \leq 5.5V$, $I_{OUT} = 1.5A$	594	600	606	mV
		$T_J = -40^{\circ}C$ to $+125^{\circ}C$, $I_{OUT} = 1.5A$	591	600	609	
FB current	I_{FB}	$V_{FB} = 0.63V$		50	100	nA
P-channel MOSFET on resistance	$R_{DS(ON)_P}$	$V_{IN} = 5V$		75		m Ω
N-channel MOSFET on resistance	$R_{DS(ON)_N}$	$V_{IN} = 5V$		45		m Ω
Switch leakage		$V_{EN} = 0V$, $V_{IN} = 6V$, $V_{SW} = 0V$ and $6V$, $T_J = 25^{\circ}C$		0	1	μA
P-channel MOSFET peak current limit			2.8		4	A
N-channel MOSFET valley current limit				3.5		A
On time	t_{ON}	$V_{IN} = 5V$, $V_{OUT} = 1.2V$		220		ns
		$V_{IN} = 3.6V$, $V_{OUT} = 1.2V$		300		
Switching frequency	f_{SW}	$V_{OUT} = 1.2V$, $I_{OUT} = 0.5A$		1100		kHz
Minimum off time	t_{MIN_OFF}			100		ns
Minimum on time ⁽⁸⁾	t_{MIN_ON}			60		ns
Soft-start time	t_{SS_ON}	V_{OUT} rising from 0% to 100%		1.2		ms
EN turn-on delay		EN on to SW active		220		μs
EN input logic-low voltage					0.4	V
EN input logic-high voltage			1.2			V
Output discharge resistor	R_{DIS}	$V_{EN} = 0V$, $V_{OUT} = 1.2V$		13		Ω
EN input current		$V_{EN} = 2V$		1.2		μA
		$V_{EN} = 0V$		0		μA
Shutdown supply current		$V_{EN} = 0V$, $T_J = 25^{\circ}C$		0	1	μA
Quiescent supply current		$V_{EN} = 2V$, $V_{FB} = 0.63V$, $V_{IN} = 5V$, $T_J = 25^{\circ}C$		450		μA
Output voltage (V_{OUT}) over-voltage (OV) threshold	V_{OVP}		112%	117%	122%	V_{FB}
V_{OUT} over-voltage protection (OVP) hysteresis	V_{OVP_HYS}			13%		V_{FB}
OVP delay				12		μs
Low-side current		Current flow from SW to GND		1.5		A
Absolute V_{IN} OVP threshold		After V_{OUT} OVP enable		6.2		V

ELECTRICAL CHARACTERISTICS (continued)

$V_{IN} = 3.6V$, $T_J = -40^{\circ}C$ to $+125^{\circ}C$ ⁽⁷⁾, typical value is tested at $T_J = 25^{\circ}C$, over-temperature limit is guaranteed by characterization, unless otherwise noted.

Parameter	Symbol	Condition	Min	Typ	Max	Units
Absolute V_{IN} OVP hysteresis				400		mV
Thermal shutdown ⁽⁸⁾				160		$^{\circ}C$
Thermal hysteresis ⁽⁸⁾				30		$^{\circ}C$

Notes:

- 7) Not tested in production. Guaranteed by over-temperature correlation.
- 8) Guaranteed by engineering sample characterization.

TYPICAL CHARACTERISTICS

$V_{IN} = 3.6V$, $V_{OUT} = 1.2V$, $L = 1\mu H$, $C_{OUT} = 22\mu F$, $T_A = 25^\circ C$, unless otherwise noted.

Quiescent Current vs. Input Voltage

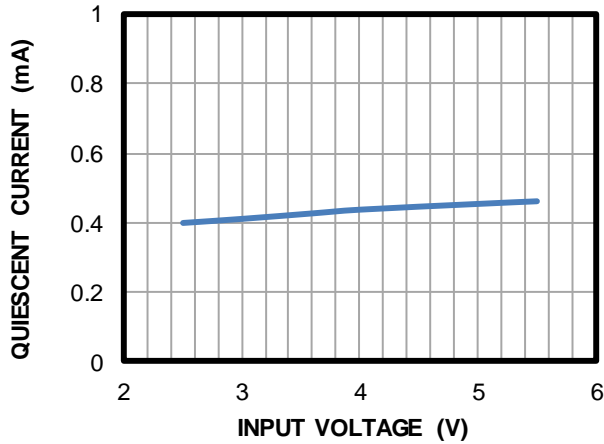

Shutdown Current vs. Input Voltage

$V_{EN} = 0V$

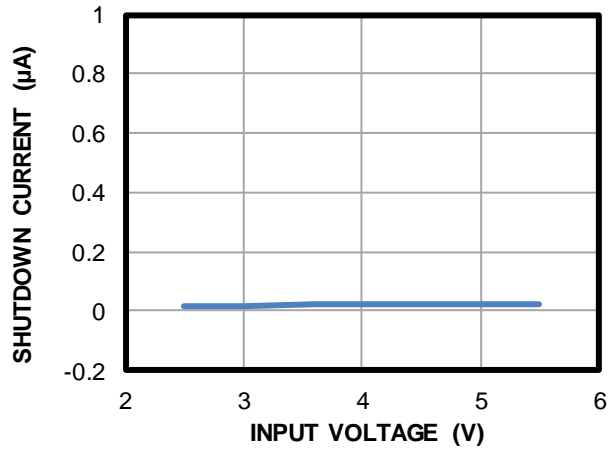

Load Regulation vs. Output Current

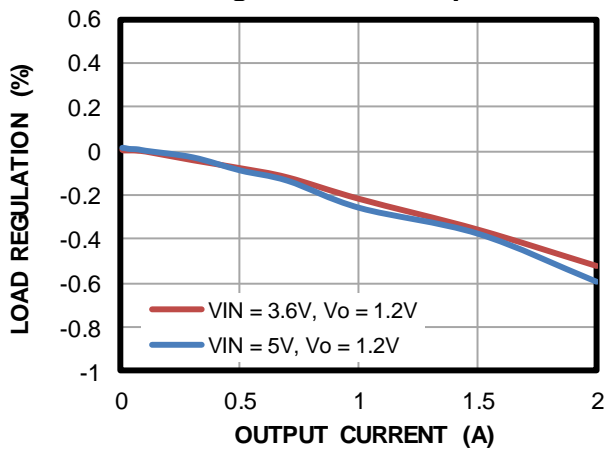

Line Regulation vs. Input Voltage

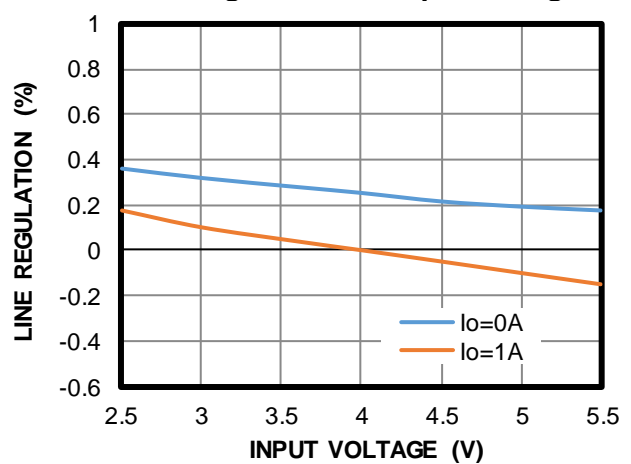

Case Temperature Rise vs. Output Current

$V_{IN} = 5V$

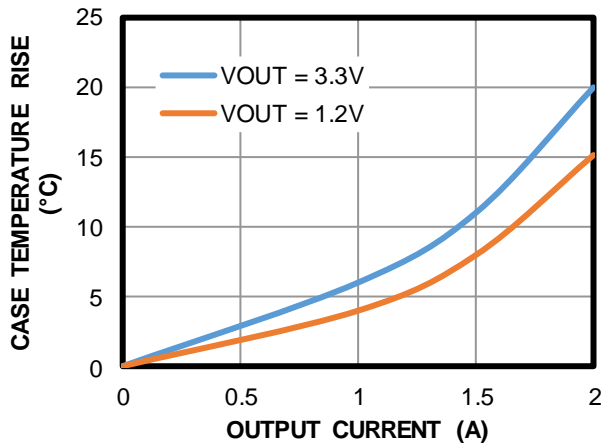

Efficiency vs. Load Current

$V_{IN} = 5V$, $L = 1\mu H$, $DCR = 10.1m\Omega$

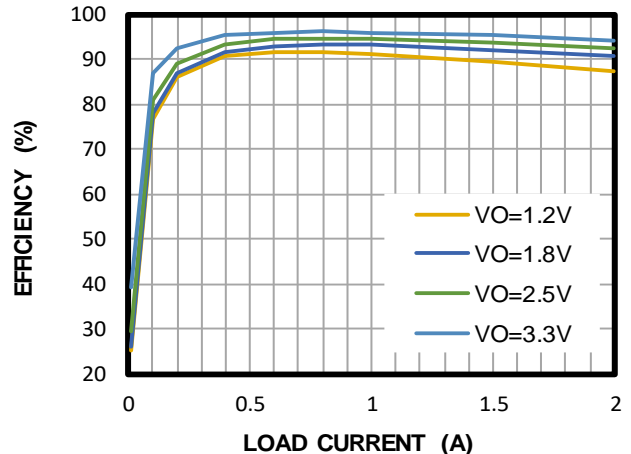

TYPICAL PERFORMANCE CHARACTERISTICS

$V_{IN} = 5V$, $V_{OUT} = 1.2V$, $L = 1\mu H$, $C_{OUT} = 22\mu F$, $T_A = 25^\circ C$, unless otherwise noted.

Efficiency vs. Load Current

$V_{IN} = 3.6V$, $L = 1\mu H$, $DCR = 10.1m\Omega$

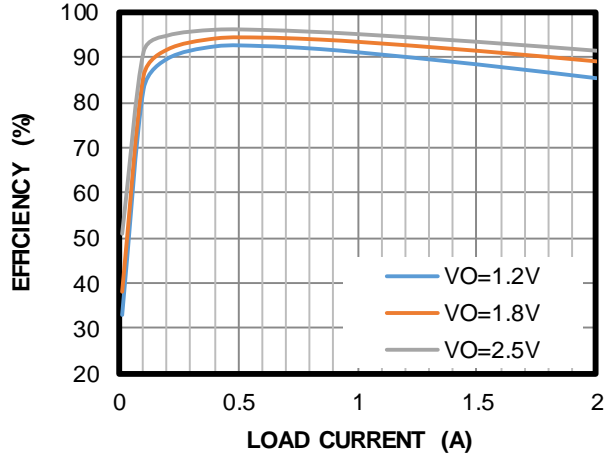

EN Rising and Falling Threshold vs. Temperature

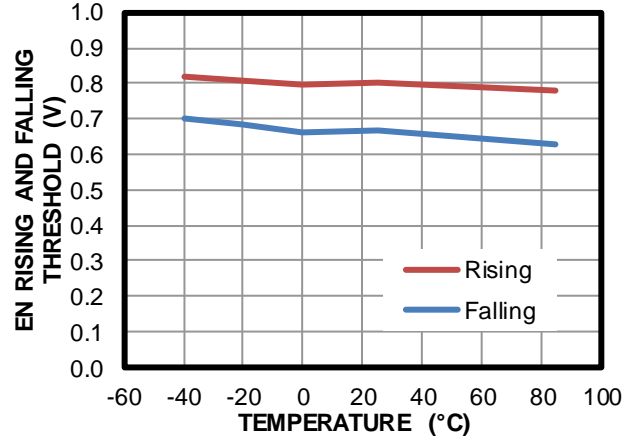

V_{IN} UVLO Rising and Falling Threshold vs. Temperature

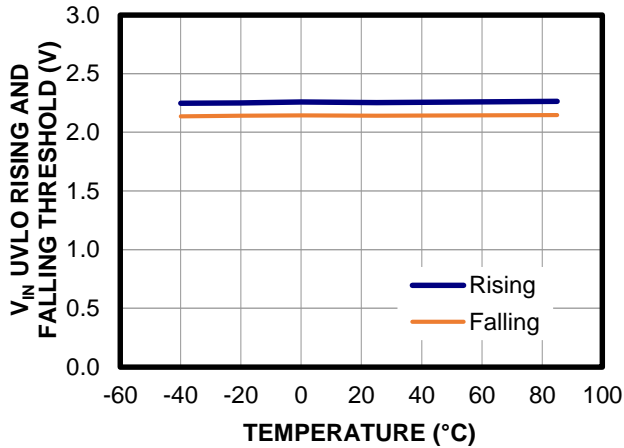

Switching Frequency vs. Temperature

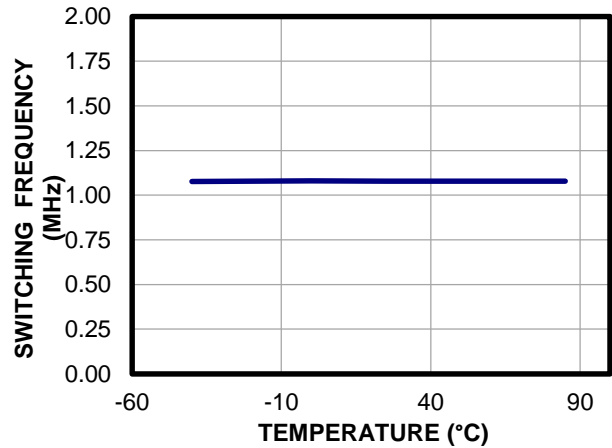

Reference Voltage vs. Temperature

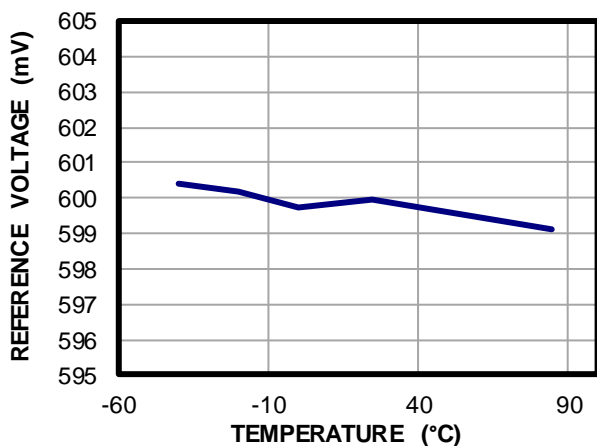

V_{OUT} OVP Rising and Falling Threshold vs. Temperature

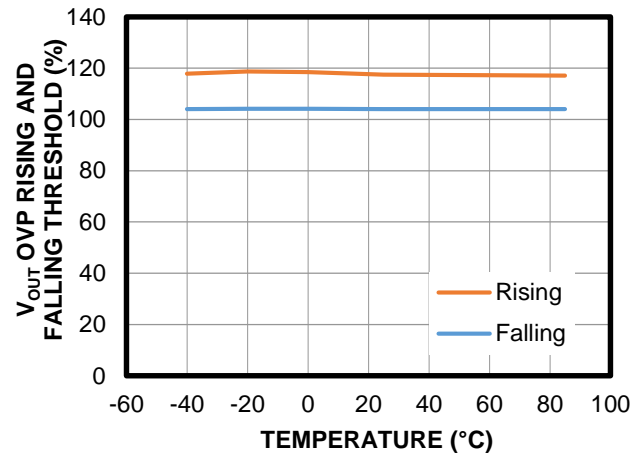

TYPICAL PERFORMANCE CHARACTERISTICS (continued)
 $V_{IN} = 5V$, $V_{OUT} = 1.2V$, $L = 1\mu H$, $C_{OUT} = 22\mu F$, $T_A = 25^\circ C$, unless otherwise noted.

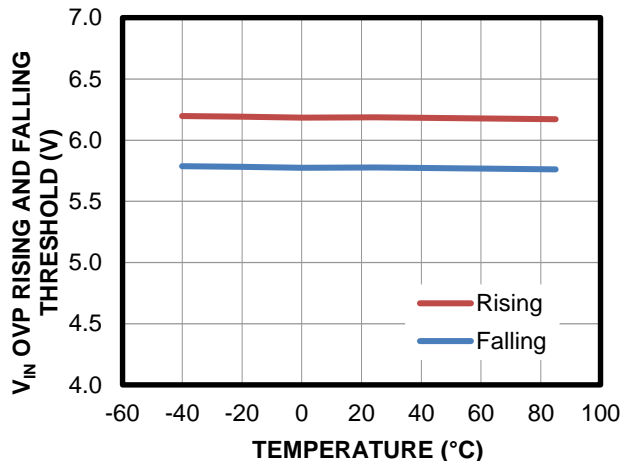
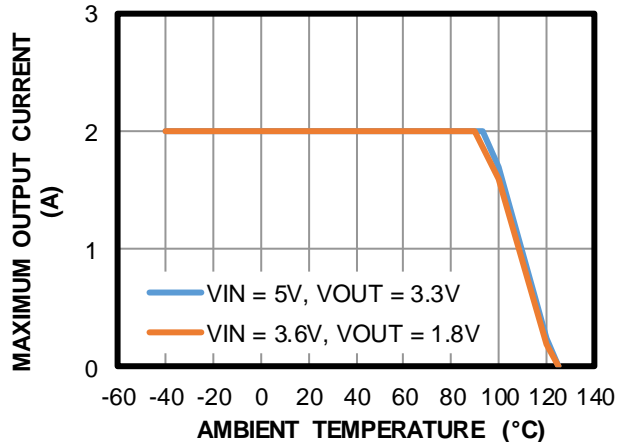
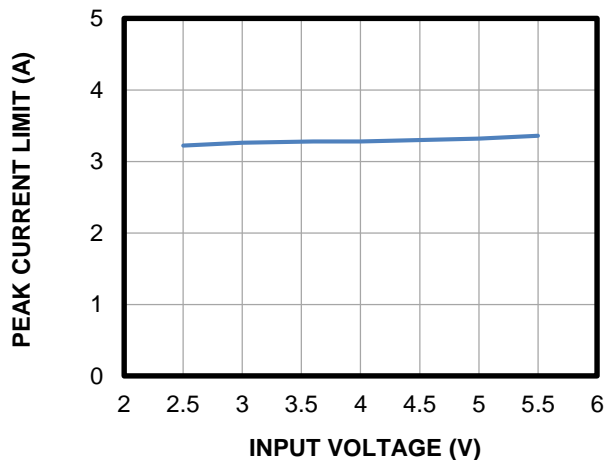
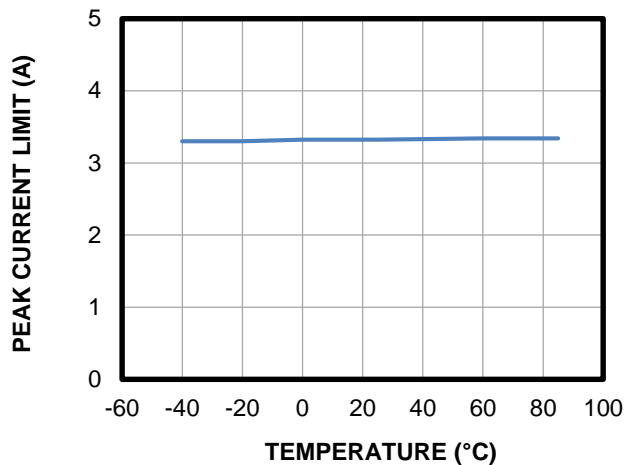
 V_{IN} OVP Rising and Falling Threshold vs. Temperature

Output Current Derating vs. Ambient Temperature
 $T_J \leq 125^\circ C$

Peak Current Limit vs. Input Voltage

Peak Current Limit vs. Temperature

TYPICAL PERFORMANCE CHARACTERISTICS (continued)

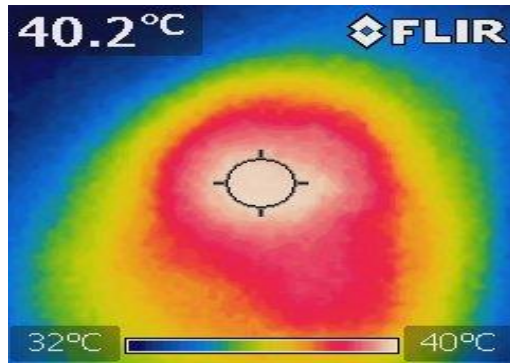
$V_{IN} = 5V$, $V_{OUT} = 1.2V$, $L = 1\mu H$, $C_{OUT} = 22\mu F$, $T_A = 25^\circ C$, unless otherwise noted.

Thermal

$V_{IN} = 5V$, $V_{OUT} = 1.2V$, $I_{OUT} = 2A$, 2-layer
(64mmx48mm) PCB



Thermal

$V_{IN} = 5V$, $V_{OUT} = 1.8V$, $I_{OUT} = 2A$, 2-layer
(64mmx48mm) PCB

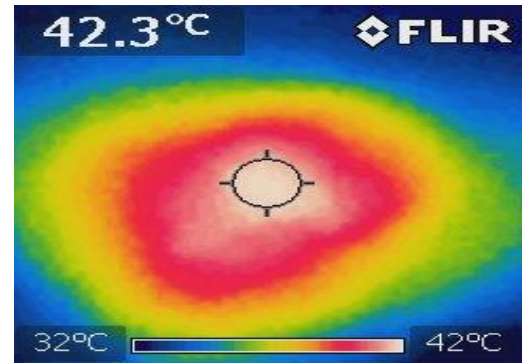

Thermal

$V_{IN} = 5V$, $V_{OUT} = 2.5V$, $I_{OUT} = 2A$, 2-layer
(64mmx48mm) PCB

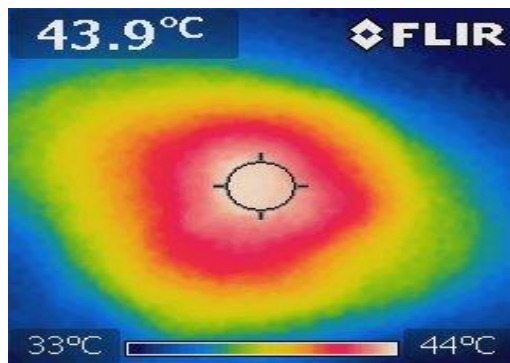

Thermal

$V_{IN} = 5V$, $V_{OUT} = 3.3V$, $I_{OUT} = 2A$, 2-layer
(64mmx48mm) PCB

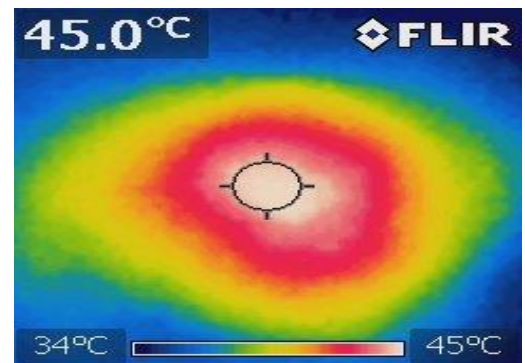

TYPICAL PERFORMANCE CHARACTERISTICS (continued)
 $V_{IN} = 5V, V_{OUT} = 1.2V, L = 1\mu H, C_{OUT} = 22\mu F, T_A = 25^\circ C$, unless otherwise noted.

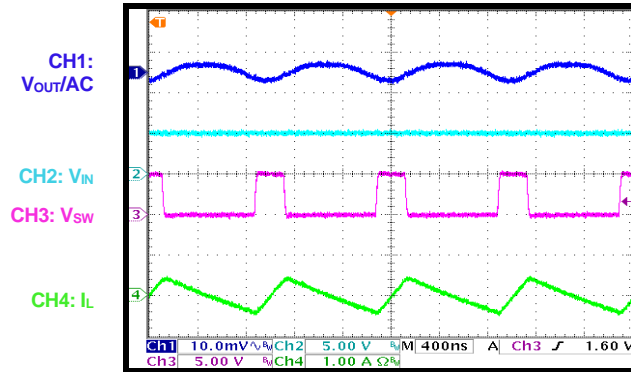
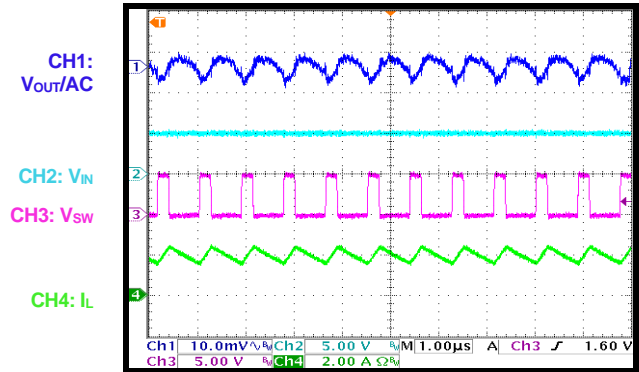
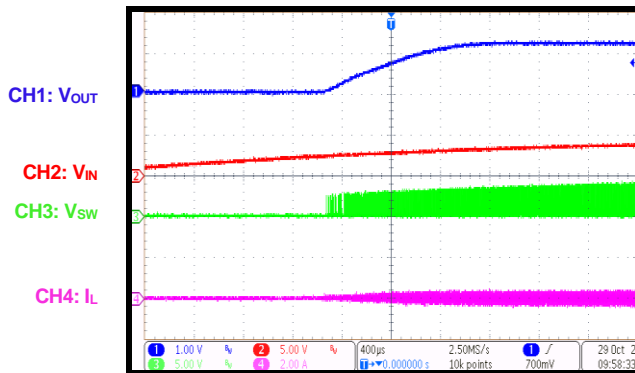
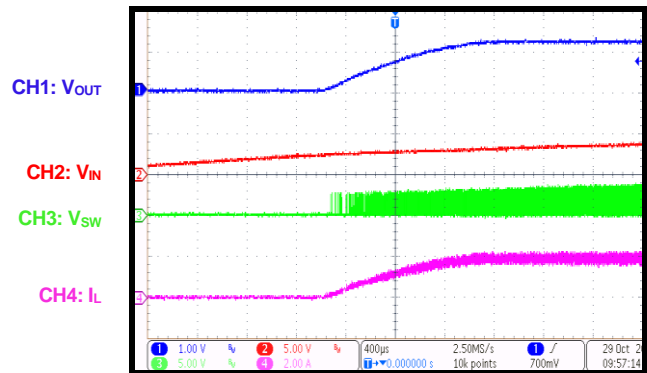
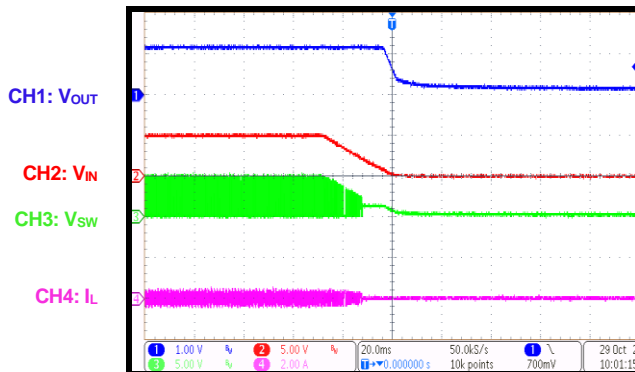
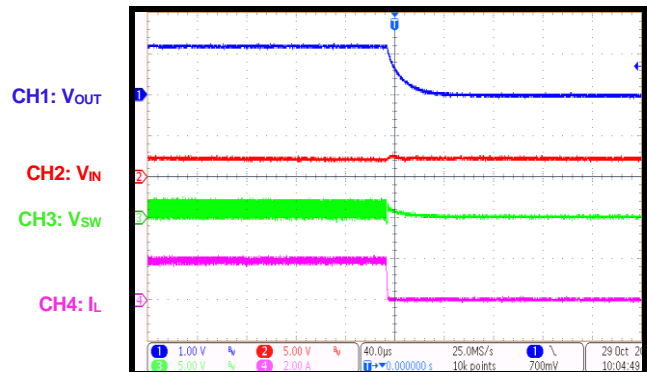
Steady State
 $I_{OUT} = 0A$

Steady State
 $I_{OUT} = 2A$

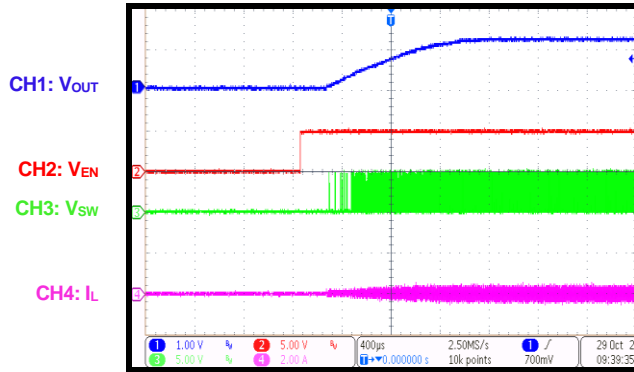
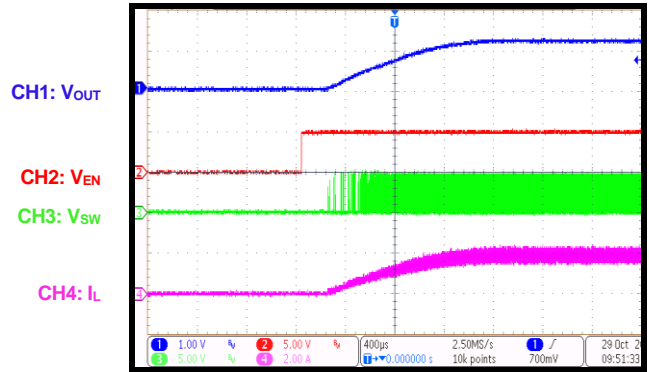
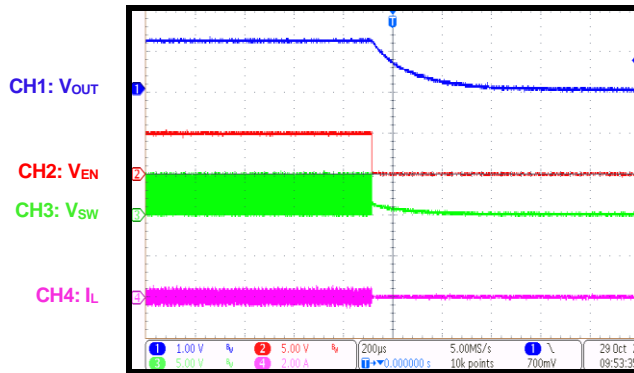
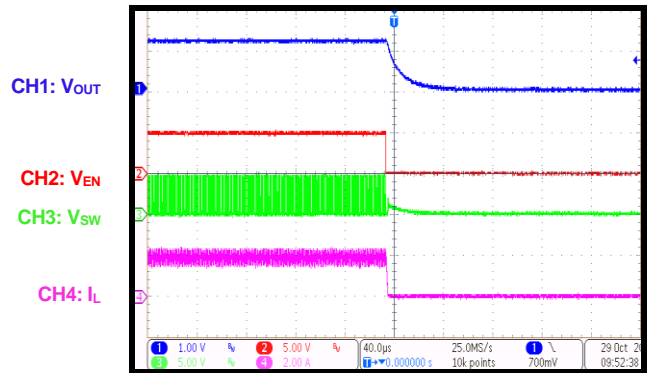
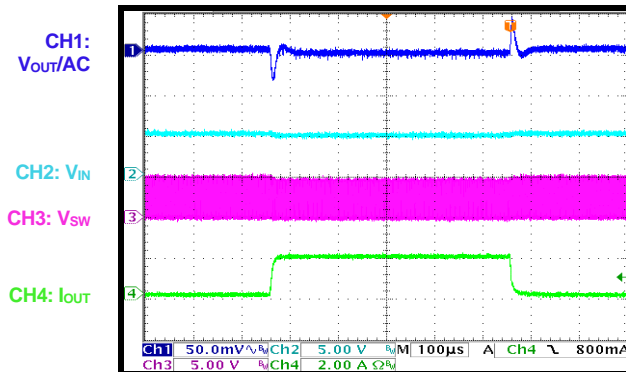
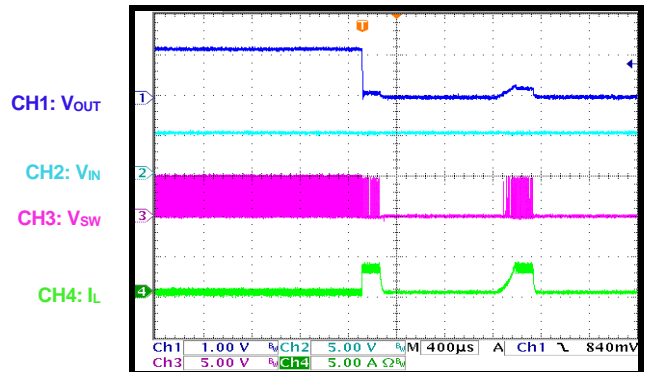
Start-Up through VIN
 $I_{OUT} = 0A$

Start-Up through VIN
 $I_{OUT} = 2A$

Shutdown through VIN
 $I_{OUT} = 0A$

Shutdown through VIN
 $I_{OUT} = 2A$

TYPICAL PERFORMANCE CHARACTERISTICS (continued)
 $V_{IN} = 5V$, $V_{OUT} = 1.2V$, $L = 1\mu H$, $C_{OUT} = 22\mu F$, $T_A = 25^\circ C$, unless otherwise noted.

Start-Up through EN
 $I_{OUT} = 0A$

Start-Up through EN
 $I_{OUT} = 2A$

Shutdown through EN
 $I_{OUT} = 0A$

Shutdown through EN
 $I_{OUT} = 2A$

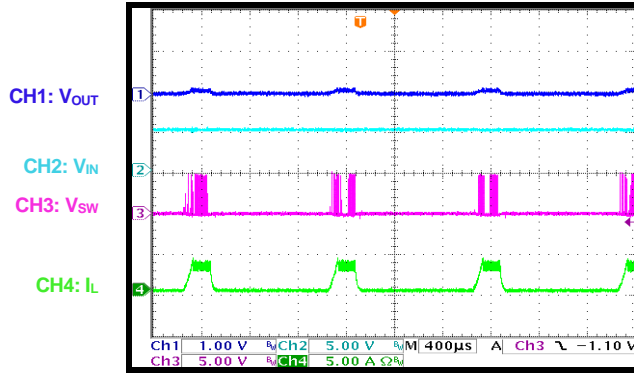
Load Transient
 $V_{IN} = 5V$, $I_{OUT} = 0A$ to $2A$

Short-Circuit Protection Entry

TYPICAL PERFORMANCE CHARACTERISTICS (continued)

$V_{IN} = 5V$, $V_{OUT} = 1.2V$, $L = 1\mu H$, $C_{OUT} = 22\mu F$, $T_A = 25^\circ C$, unless otherwise noted.

Short-Circuit Protection Steady State



Short-Circuit Protection Recovery

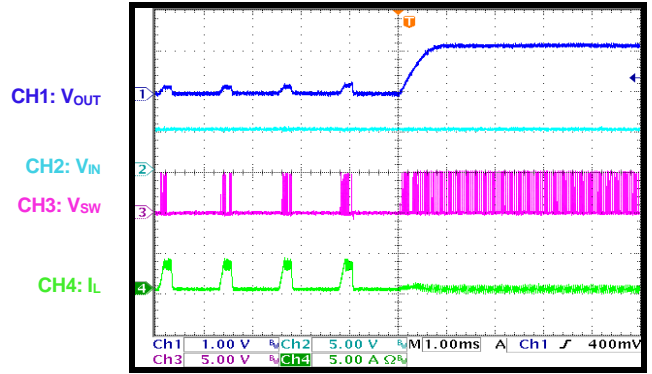

FUNCTIONAL BLOCK DIAGRAM

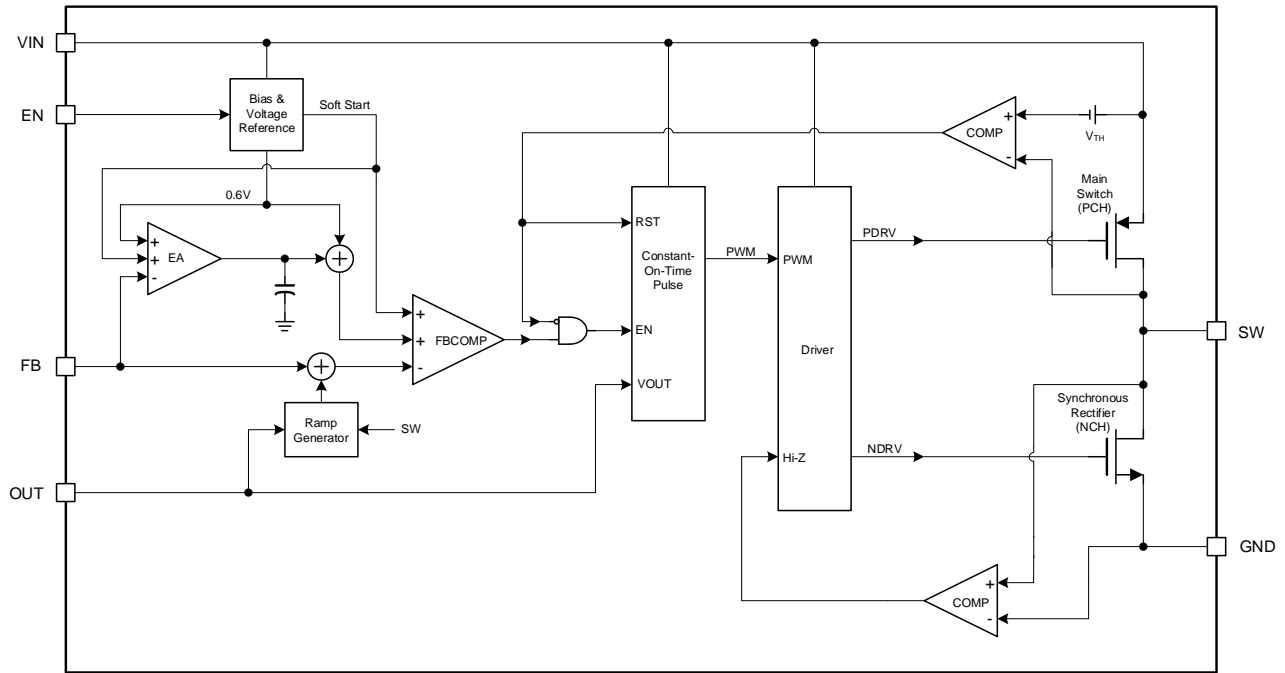

Figure 1: Functional Block Diagram

OPERATION

The MP2192C uses constant-on-time (COT) control with input voltage (V_{IN}) feed-forward to stabilize the switching frequency (f_{SW}) across the entire V_{IN} range. It achieves up to 2A of continuous output current (I_{OUT}) from a 2.5V to 5.5V V_{IN} , with excellent load and line regulation. The output voltage (V_{OUT}) can be regulated to as low as 0.6V.

Constant-On-Time (COT) Control

Compared to fixed-frequency pulse-width modulation (PWM) control, COT control offers a simpler control loop and a faster transient response. By using V_{IN} feed-forward, the MP2192C maintains a nearly constant f_{SW} across the V_{IN} and V_{OUT} ranges. The switching pulse on time (t_{ON}) can be estimated with Equation (1):

$$t_{ON} = \frac{V_{OUT}}{V_{IN}} \times 0.91\mu\text{s} \quad (1)$$

To prevent inductor current (I_L) runaway during load transient, the MP2192C has fixed minimum off time of 100ns.

Forced Pulse-Width Modulation (PWM) Operation

The MP2192C works in continuous conduction mode (CCM) to achieve a smaller V_{OUT} ripple, load regulation, and load transient across the entire load range.

Enable (EN)

When V_{IN} exceeds the under-voltage lockout (UVLO) threshold (typically 2.3V), the MP2192C can be enabled by pulling the EN pin above 1.2V. Float the EN pin float or pull it down to ground to disable the MP2192C. There is an internal 1M Ω resistor from the EN pin to ground.

When the device is disabled, the part goes into output discharge mode automatically, and the internal discharge MOSFET provides a resistive discharge path for the output capacitor.

Soft Start (SS)

The MP2192C features built-in soft start (SS), which ramps up V_{OUT} at a controlled slew rate to avoid overshoot at startup. The soft-start time (t_{SS}) is typically 1.2ms.

Current Limit

The MP2192C typically has a 4A (maximum) high-side switching current limit. When the high-side MOSFET (HS-FET) reaches its current limit, the MP2192C remains in hiccup mode until the current drops. This prevents I_L from continuing to rise and possibly damaging components.

Short Circuit and Recovery

If the MP2192C reaches its current limit, the device enters short-circuit protection (SCP) and tries to recover with hiccup mode. The MP2192C disables the output power (P_{OUT}) stage, discharges the soft-start capacitor (C_{SS}) then automatically tries to soft start again. If the short-circuit condition remains after SS ends, then the MP2192C repeats this cycle until the short circuit disappears and the output rises back to regulation level.

Over-Voltage Protection (OVP)

The MP2192C monitors feedback (FB) voltage (V_{FB}) to detect over-voltage (OV) conditions. If V_{FB} exceeds 117% of the reference voltage (V_{REF}), the controller enters the dynamic regulation period. During this period, the low-side MOSFET (LS-FET) turns on and remains on until the low-side current goes to -1.5A to discharge the output and try to keep it within the normal range. After this, if the OV condition still exists, there is a 1 μ s delay and the LS-FET turns on again. Once V_{FB} falls below 104% of V_{REF} , the device exits this regulation period. If dynamic regulation cannot prevent V_{OUT} from increasing and the device detects V_{IN} has reached or exceeded 6.2V, over-voltage protection (OVP) occurs. At this point, the MP2192C stops switching until V_{IN} drops below 5.7V. Once V_{IN} falls below 5.7V, the MP2192C starts up again and resumes normal operation.

APPLICATION INFORMATION

Setting the Output Voltage

The external resistor divider sets V_{OUT} (see Figure 4 on page 17). When selecting the FB resistor (R1), consider reducing the V_{OUT} leakage current (typically 100kΩ to 200kΩ). There is no strict requirement for R1. An R1 value above 10kΩ is recommended for most applications. R2 is then calculated with Equation (2):

$$R2 = \frac{R1}{\frac{V_{OUT}}{0.6} - 1} \quad (2)$$

Figure 2 shows the feedback circuit.

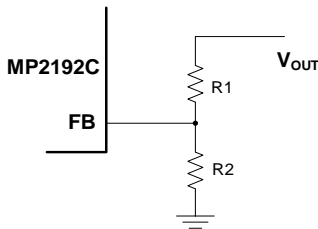

Figure 2: Feedback Network

Table 1 lists the recommended resistor values for common output voltages.

Table 1: Resistor Values for Common Output Voltages

V_{OUT} (V)	R1 (kΩ)	R2 (kΩ)
1	200 (1%)	300 (1%)
1.2	200 (1%)	200 (1%)
1.8	200 (1%)	100 (1%)
2.5	200 (1%)	63.2 (1%)
3.3	200 (1%)	44.2 (1%)

Selecting the Inductor



**Optimized Performance with MPS Inductor
MPL-AL4020 Series**

Most applications work best with a 1μH to 2.2μH inductor. Select an inductor with a DC resistance below 50mΩ to optimize efficiency.

A high-frequency, switch-mode power supply with a magnetic device can introduce strong electromagnetic interference (EMI) to the system. Unshielded power inductor should be avoided, as they provide poor magnetic shielding. Shielded inductors, such as metal alloy or multilayer chip power inductors, are recommended as they can effectively reduce

EMI. For most designs, the inductance (L_1) can be estimated using Equation (3):

$$L_1 = \frac{V_{OUT} \times (V_{IN} - V_{OUT})}{V_{IN} \times \Delta I_L \times f_{OSC}} \quad (3)$$

Where ΔI_L is the inductor ripple current.

Choose the inductor current (I_L) to be approximately 30% of the maximum load current. The maximum peak inductor current ($I_{L(MAX)}$) is calculated with Equation (4):

$$I_{L(MAX)} = I_{LOAD} + \frac{\Delta I_L}{2} \quad (4)$$

MPS inductors are optimized and tested for use with our complete line of integrated circuits. Table 2 lists recommended power inductors. Select a part number based on the relevant design requirements.

Table 2: Recommended Power Inductors

Part Number	Inductance	Manufacturer
MPL-AL4020-1R0	1μH	MPS
MPL-AL4020-1R2	1.2μH	MPS
MPL-AL4020-1R5	1.5μH	MPS
MPL-AL4020-2R2	2.2μH	MPS

Visit MonolithicPower.com under Products > Inductors for more information.

Selecting the Input Capacitor

The step-down converter has a discontinuous input current, and requires a capacitor to supply the AC current to the converter while maintaining the DC V_{IN} . Use low-ESR capacitors for the best performance. Ceramic capacitors with X5R or X7R dielectrics are strongly recommended due to their low ESR and small temperature coefficients. For most applications, a 22μF capacitor is sufficient. Higher output voltages may require a 44μF capacitor to increase system stability.

The input capacitor requires an adequate ripple current rating because it absorbs the input switching current. Estimate the RMS current (I_{C1}) in the input capacitor with Equation (5):

$$I_{C1} = I_{LOAD} \times \sqrt{\frac{V_{OUT}}{V_{IN}} \times \left(1 - \frac{V_{OUT}}{V_{IN}}\right)} \quad (5)$$

The worst-case scenario occurs at $V_{IN} = 2 \times V_{OUT}$, which can be calculated with Equation (6):

$$I_{C1} = \frac{I_{LOAD}}{2} \quad (6)$$

For simplification, choose an input capacitor with an RMS current rating greater than half of the maximum load current.

The input capacitor can be electrolytic, tantalum, or ceramic. When using electrolytic or tantalum capacitors, place a small, high-quality ceramic capacitor (e.g. 0.1µF) as close to the IC as possible. When using ceramic capacitors, ensure that they have enough capacitance to provide sufficient charge to prevent excessive voltage ripple at the input. The input voltage ripple (ΔV_{IN}) caused by capacitance can be estimated with Equation (7):

$$\Delta V_{IN} = \frac{I_{LOAD}}{f_{SW} \times C1} \times \frac{V_{OUT}}{V_{IN}} \times \left(1 - \frac{V_{OUT}}{V_{IN}}\right) \quad (7)$$

Selecting the Output Capacitor

The output capacitor (C2) stabilizes the DC V_{OUT} . Ceramic capacitors are recommended. Low-ESR capacitors are preferred to limit the output voltage ripple. Estimate the output voltage ripple (ΔV_{OUT}) with Equation (8):

$$\Delta V_{OUT} = \frac{V_{OUT}}{f_{SW} \times L_1} \times \left(1 - \frac{V_{OUT}}{V_{IN}}\right) \times \left(R_{ESR} + \frac{1}{8 \times f_{SW} \times C2}\right) \quad (8)$$

Where L_1 is the inductance, and R_{ESR} is the equivalent series resistance (ESR) of the output capacitor.

When using ceramic capacitors, the capacitance dominates the impedance at f_{SW} , and causes the majority of ΔV_{OUT} . For simplification, the output voltage ripple (ΔV_{OUT}) can be estimated with Equation (9):

$$\Delta V_{OUT} = \frac{V_{OUT}}{8 \times f_{SW}^2 \times L_1 \times C2} \times \left(1 - \frac{V_{OUT}}{V_{IN}}\right) \quad (9)$$

For tantalum or electrolytic capacitors, the ESR dominates the impedance at f_{SW} . For

simplification, the output voltage ripple (ΔV_{OUT}) can be estimated with Equation (10):

$$\Delta V_{OUT} = \frac{V_{OUT}}{f_{SW} \times L_1} \times \left(1 - \frac{V_{OUT}}{V_{IN}}\right) \times R_{ESR} \quad (10)$$

The characteristics of the output capacitor also affect the stability of the regulation system.

PCB Layout Guidelines

Proper PCB layout is critical for proper function. Poor layout design can result in poor line or load regulation and stability issues. For the best results, refer to Figure 3 and follow the guidelines below:

1. Place the high-current paths (GND, VIN, and SW) very close to the device with short, direct, and wide traces.
2. Place the input capacitor as close as possible to the VIN and GND pins.
3. Place the external feedback resistors next to the FB pin.
4. Keep the switching node (SW) short and away from the feedback network.
5. Keep the V_{OUT} sense line as short as possible and away from the power inductor (especially from surrounding the inductor).

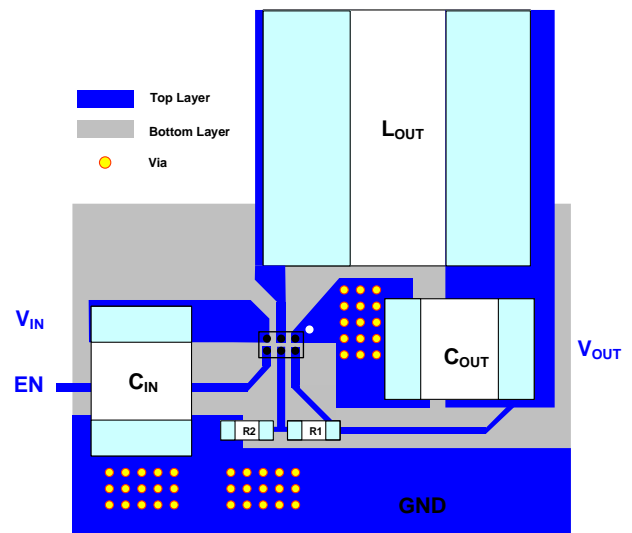

Figure 3: Recommended PCB Layout

TYPICAL APPLICATION CIRCUITS

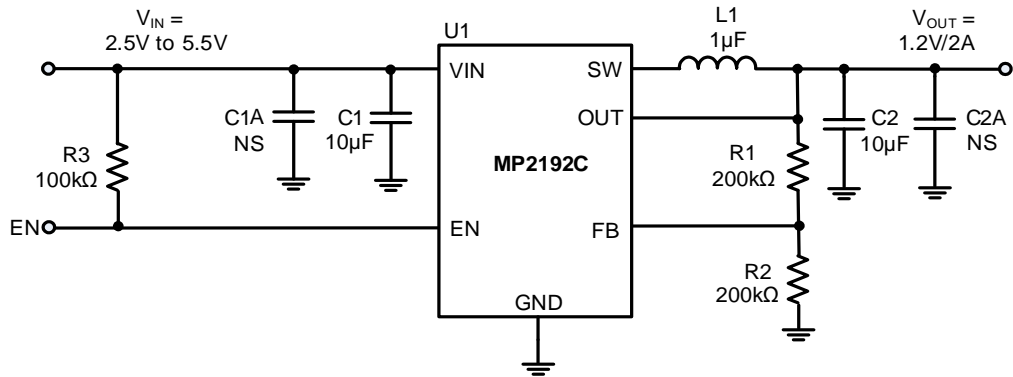

Figure 4: Typical Application Circuit ⁽⁹⁾

Note:

9) For applications where $V_{IN} < 3.3V$, additional input capacitance may be required.

PACKAGE INFORMATION

WLCSP-6 (0.85mmx1.25mm)

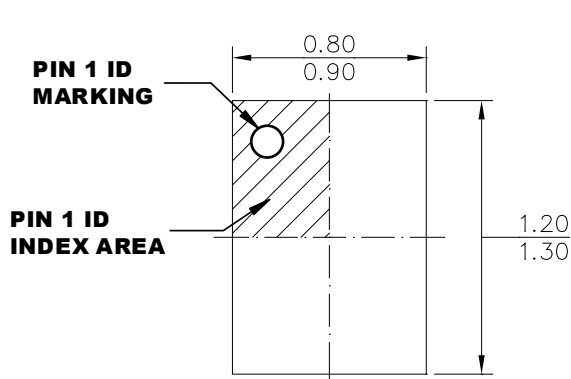

TOP VIEW

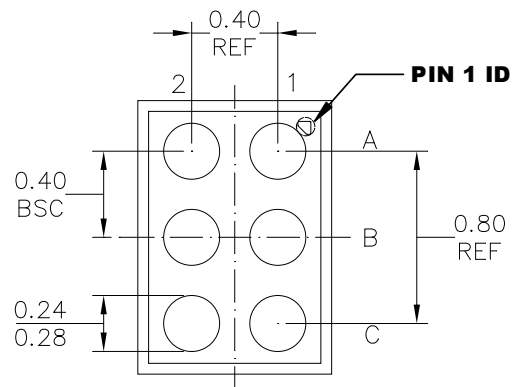

BOTTOM VIEW

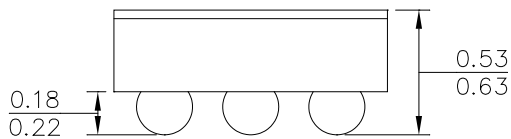

SIDE VIEW

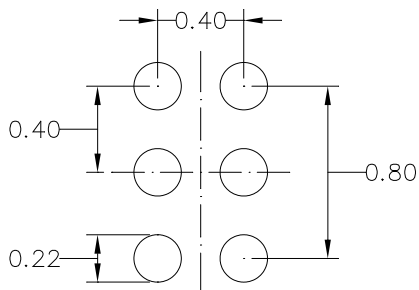

RECOMMENDED LAND PATTERN

NOTE:

- 1) ALL DIMENSIONS ARE IN MILLIMETERS.
- 2) BALL COPLANARITY SHALL BE 0.05 MILLIMETER MAX.
- 3) JEDEC REFERENCE IS MO-211.
- 4) DRAWING IS NOT TO SCALE.

CARRIER INFORMATION

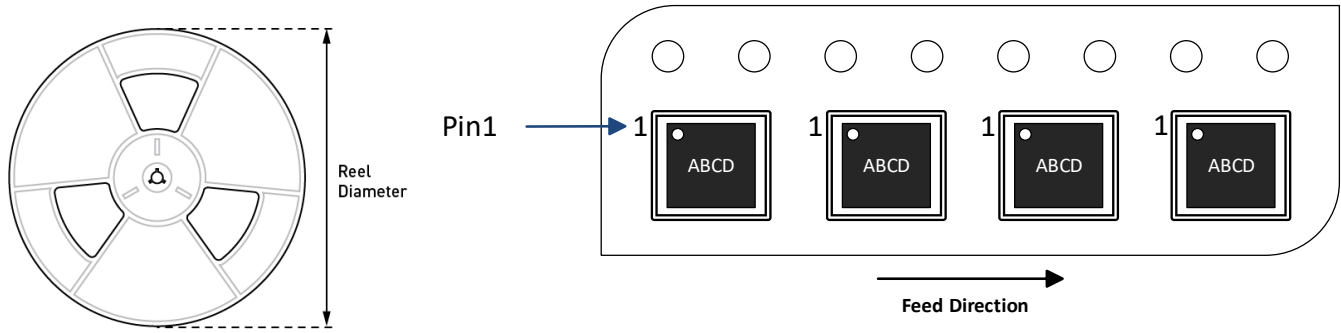

Part Number	Package Description	Quantity/ Reel	Quantity/ Tube	Quantity/ Tray	Reel Diameter	Carrier Tape Width	Carrier Tape Pitch
MP2192CGC-Z	WLCSP-6 (0.85mmx1.25mm)	3000	N/A	N/A	7in	8mm	4mm



REVISION HISTORY

Revision #	Revision Date	Description	Pages Updated
1.0	7/5/2022	Initial Release	-

Notice: The information in this document is subject to change without notice. Please contact MPS for current specifications. Users should warrant and guarantee that third-party Intellectual Property rights are not infringed upon when integrating MPS products into any application. MPS will not assume any legal responsibility for any said applications.