



# MP28310

300mA, 2V to 5.5V, 500nA  $I_Q$ , Step-Down Converter with 300nA  $I_Q$ , 2V to 5.5V, 100mA LDO Regulator in CSP-12 (1.2mmx1.6mm)

## DESCRIPTION

The MP28310 is a monolithic power management unit containing a 300mA, high-efficiency, switching step-down converter and a 100mA low-dropout (LDO) regulator. The ultra-low 500nA quiescent current ( $I_Q$ ) provides extremely high efficiency when the load current is within the  $\mu$ A range. The MP28310's low 2V minimum input voltage allows the system to operate directly from the battery.

Constant-on-time (COT) control provides fast transient response and high light-load efficiency, and requires minimal capacitance. Good regulation is achieved by integrating an error amplifier (EA) to correct the output voltage ( $V_{OUT}$ ).

The 100mA LDO regulator provides easy system configuration and a clean  $V_{OUT}$ . The control (CTRL) pins control the on/off and  $V_{OUT}$  selection functions.

Fault protection features include under-voltage lockout (UVLO), over-current protection (OCP), and thermal shutdown.

The MP28310 requires a minimal number of readily available, standard external components, and is available in a small CSP-12 (1.2mmx1.6mm) package.

## FEATURES

- **300mA Buck Converter**
  - Ultra-Low 500nA Quiescent Current ( $I_Q$ )
  - Wide 2V to 5.5V Operating Input Range
  - 7 Selectable Output Voltages
  - Up to 300mA of Output Current
  - 1.5MHz Switching Frequency in Continuous Conduction Mode (CCM)
  - 100% Duty Cycle in Low-Dropout Mode
  - 0.25 $\Omega$  and 0.25 $\Omega$  Internal Power MOSFET Switches
  - Cycle-by-Cycle Over-Current Protection (OCP)
  - Short-Circuit Protection (SCP) with Hiccup Mode
- **100mA LDO**
  - Ultra-Low 300nA  $I_Q$
  - 2V to 5.5V Operating Input Range
  - 3 Selectable Output Voltages
  - Over-Temperature Protection (OTP)
- Available in a CSP-12 (1.2mmx1.6mm) Package

## APPLICATIONS

- Wearables
- Internet of Things (IoT)
- Portable Instruments
- Battery-Powered Devices

All MPS parts are lead-free, halogen-free, and adhere to the RoHS directive. For MPS green status, please visit the MPS website under Quality Assurance. "MPS", the MPS logo, and "Simple, Easy Solutions" are trademarks of Monolithic Power Systems, Inc. or its subsidiaries.

## TYPICAL APPLICATION

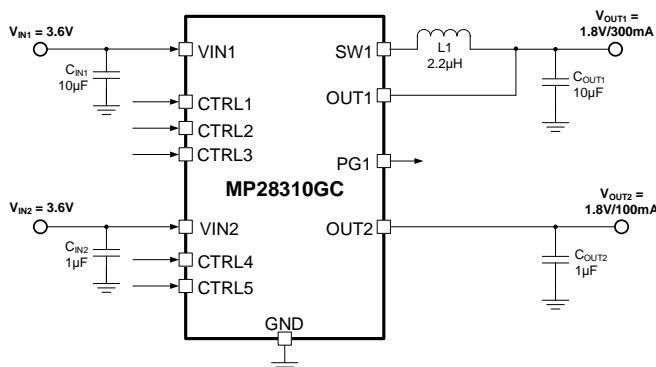

Efficiency vs. Load Current  
 $V_{OUT} = 1.8V$

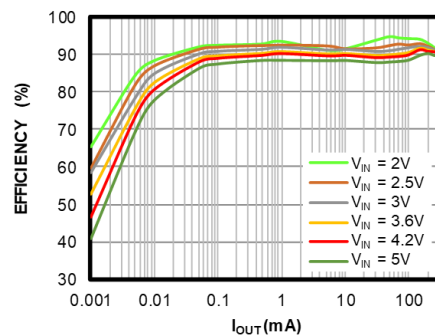

### ORDERING INFORMATION

Part Number*	Package	Top Marking	MSL Rating
MP28310GC	CSP-12 (1.2mmx1.6mm)	See Below	1

\* For Tape & Reel, add suffix -Z (e.g. MP28310GC-Z).

### TOP MARKING

**FAY**

**LLL**

FA: Product code of MP28310GC

Y: Year code

LLL: Lot number

### PACKAGE REFERENCE

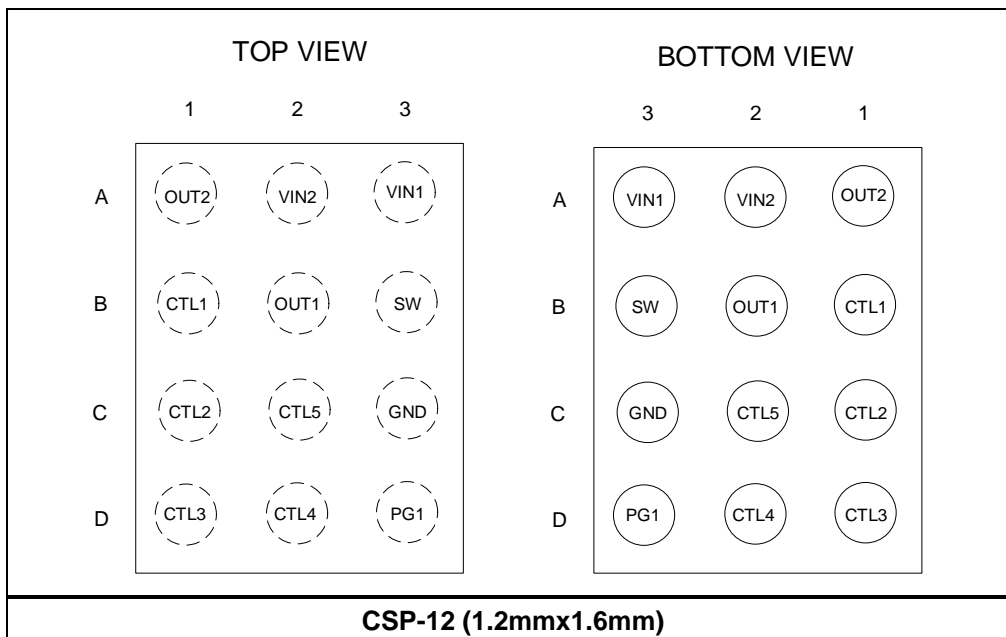

**PIN FUNCTIONS**

Pin #	Name	Description
A1	OUT2	<b>LDO output voltage sensor.</b> OUT2 is the output of the linear regulator. Use a 1 $\mu$ F output capacitor to bypass OUT2 to GND.
A2	VIN2	<b>LDO input supply voltage.</b> Place a small decoupling capacitor as close to VIN2 and GND as possible.
A3	VIN1	<b>Step-down converter input supply voltage.</b> Place a small decoupling capacitor as close to VIN1 and GND as possible.
B1	CTL1	<b>Step-down converter control signal (CTL means CTRL).</b> These pins dynamically adjust the step-down converter's output voltage (V <sub>OUT</sub> ). Do not float the CTRL pins. When used, ensure that the CTRL voltage is above the input voltage (V <sub>IN</sub> ). If unused, tie the CTRL pin(s) to GND. See Table 1 on page 15 to set the buck output value.
C1	CTL2	
D1	CTL3	
D2	CTL4	<b>LDO control signal (CTL means CTRL).</b> These pins dynamically adjust the LDO V <sub>OUT</sub> . Do not float the CTRL pins. When used, ensure that the CTRL voltage is above V <sub>IN</sub> . If unused, tie the CTRL pin(s) to GND. See Table 1 on page 15 to set the LDO output value.
C2	CTL5	
C3	GND	<b>Ground.</b>
D3	PG1	<b>Step-down converter power good (PG) indicator.</b> PG1 is an open-drain output.
B2	OUT1	<b>Step-down converter output voltage sensor.</b> Connect the load to OUT1. Use an output capacitor to reduce the output voltage ripple.
B3	SW	<b>Step-down converter switch output.</b> SW is the drain of the internal high-side MOSFET (HS-FET). Connect the inductor to SW to complete the converter.

**ABSOLUTE MAXIMUM RATINGS** <sup>(1)</sup>

Supply voltage (V <sub>IN1/2</sub> )	6V
V <sub>SW1</sub>	-0.3V to V <sub>IN</sub> + 0.3V
	-0.3V (-5V for <10ns) to +6V (8V for <10ns or 10V for <3ns)
All other pins	-0.3V to +6V
Continuous power dissipation (T <sub>A</sub> = +25°C) <sup>(2)(4)</sup>	
EV28310-C-00A	2.27W
Junction temperature	150°C
Lead temperature	260°C
Storage temperature	-65°C to +150°C

**ESD Ratings**

Human body model (HBM)	2000V
Charged device model (CDM)	±1750V

**Recommended Operating Conditions** <sup>(3)</sup>

Supply voltage (V <sub>IN1/2</sub> )	2.0V to 5.5V
Operating junction temp (T <sub>J</sub> )	-40°C to +125°C

<b>Thermal Resistance</b>	<b>θ<sub>JA</sub></b>	<b>θ<sub>JC</sub></b>
EV28310-C-00A <sup>(4)</sup>	55	8.2
CSP-12 (1.2mmx1.6mm) <sup>(5)</sup>	95	30

**Notes:**

- 1) Exceeding these ratings may damage the device.
- 2) The maximum allowable power dissipation is a function of the maximum junction temperature, T<sub>J</sub> (MAX), the junction-to-ambient thermal resistance θ<sub>JA</sub>, and the ambient temperature T<sub>A</sub>. The maximum allowable continuous power dissipation at any ambient temperature is calculated by P<sub>D</sub> (MAX) = (T<sub>J</sub> (MAX) - T<sub>A</sub>) / θ<sub>JA</sub>. Exceeding the maximum allowable power dissipation may produce an excessive die temperature, which can cause the regulator to go into thermal shutdown. Internal thermal shutdown circuitry protects the device from permanent damage.
- 3) The device is not guaranteed to function outside of its operating conditions.
- 4) Measured on EV28310-C-00A, 2-layer, 63mmx63mm PCB.
- 5) The value of θ<sub>JA</sub> given in this table is only valid for comparison with other packages and cannot be used for design purposes. These values were calculated in accordance with JESD51-7, and simulated on a specified JEDEC board. They do not represent the performance obtained in an actual application.

## ELECTRICAL CHARACTERISTICS

V<sub>IN1</sub> = 3.6V, V<sub>IN2</sub> = 3.6V, T<sub>J</sub> = -40°C to +125°C <sup>(6)</sup>, typical value is tested at T<sub>J</sub> = 25°C. The limit over-temperature is guaranteed by characterization, unless otherwise noted.

Parameters	Symbol	Condition	Min	Typ	Max	Units
<b>Buck Converter</b>						
Input voltage range	V <sub>IN1</sub>		2		5.5	V
Buck under-voltage lockout (UVLO) rising threshold	V <sub>IN1_UVLO_R</sub>		1.65	1.8	1.95	V
Buck UVLO threshold hysteresis	V <sub>IN1_UVLO_H</sub>			150		mV
Shutdown supply current	I <sub>SD_25</sub>	CTRL1/2/3 = 0V, or EN = 0		70		nA
Quiescent supply current	I <sub>Q_BUCK</sub>	No load, CTRL4/5 = 0V, CTRL1/2/3 = H/H/L, OUT1 = 1.8V, no switching		500		nA
High-side MOSFET (HS-FET) switch on resistance	R <sub>DS(ON)1_H</sub>			0.25		Ω
Low-side MOSFET (LS-FET) switch on resistance	R <sub>DS(ON)1_L</sub>			0.25		Ω
Switch leakage current	I <sub>LK_SW1</sub>	CTRL1/2/3 = 0V, V <sub>IN1</sub> = 5.5V, V <sub>SW</sub> = 0V and 5.5V, T <sub>J</sub> = 25°C	-100	0	+100	nA
HS-FET current limit	I <sub>LIM1_H</sub>		480	600	720	mA
LS-FET valley source current	I <sub>LIMV1_L</sub>		300	400		mA
LS-FET zero-current detection	I <sub>ZCD</sub>		0	20		mA
On time	t <sub>ON</sub>	V <sub>IN1</sub> = 3.6V, V <sub>OUT</sub> = 1.8V	280	330	380	ns
LDO input voltage range	V <sub>IN2</sub>	When V <sub>IN1</sub> > V <sub>IN1_UVLO</sub>	2.0		5.5	V
Minimum on time	t <sub>MIN_ON</sub>			60		ns
Minimum off time	t <sub>MIN_OFF</sub>			100		ns
Maximum duty cycle <sup>(7)</sup>	D <sub>MAX</sub>		100			%
Output voltage accuracy	V <sub>OUT</sub>	CTRL1/2/3 = H/H/L, T <sub>J</sub> = 25°C, I <sub>OUT</sub> = 0.1A	1.782	1.8	1.818	V
		CTRL1/2/3 = H/H/L, T <sub>J</sub> = -40°C to +85°C, I <sub>OUT</sub> = 0.1A	1.773		1.827	
Buck line-load regulation <sup>(7)</sup>		From 2.5V to 5.5V, from 0A to 300mA	-1		+1	%

**ELECTRICAL CHARACTERISTICS (continued)**

V<sub>IN1</sub> = 3.6V, V<sub>IN2</sub> = 3.6V, T<sub>J</sub> = -40°C to +125°C <sup>(6)</sup>, typical value is tested at T<sub>J</sub> = 25°C. The limit over-temperature is guaranteed by characterization, unless otherwise noted.

Parameters	Symbol	Condition	Min	Typ	Max	Units
<b>LDO</b>						
Quiescent supply current	I <sub>Q_LDO</sub>	No load, CTRL1/2/3 = 0V, CTRL4/5 = H/L, no load current from V <sub>IN2</sub>		300		nA
Shutdown supply current	I <sub>SD_25</sub>	CTRL4/5 = 0V, or EN = 0		50		nA
LDO voltage dropout	V <sub>DP</sub>	I <sub>LDO</sub> = 0.1A, V <sub>OUT</sub> = 3.3V		50		mV
LDO current limit	I <sub>LIM_LDO</sub>		150	200		mA
DC output voltage accuracy	V <sub>OUT</sub>	CTRL4/5 = H/L, T <sub>J</sub> = 25°C	1.782	1.8	1.818	V
		CTRL4/5 = H/L, T <sub>J</sub> = -40°C to +85°C	1.773		1.827	
		Internal reference, T <sub>A</sub> = -40°C to +85°C	0.591	0.6	0.609	
LDO line regulation		I <sub>OUT</sub> = 1mA		0		%
LDO load regulation		I <sub>OUT</sub> = 1mA to 100mA	-1		+1	%
Power supply rejection ratio <sup>(7)</sup>	PSRR	10Hz, I <sub>OUT</sub> = 100mA		40		dB
		100Hz, I <sub>OUT</sub> = 100mA		20		
		1kHz, I <sub>OUT</sub> = 100mA		15		
<b>Buck and LDO</b>						
Internal soft-start time	t <sub>SS</sub>	Buck		0.5		ms
	t <sub>SS</sub>	LDO: V <sub>OUT</sub> = 3.3V, I <sub>OUT</sub> = 100mA, C <sub>OUT</sub> = 1μF		2		ms
Discharge resistance during shutdown	R <sub>DIS_OFF</sub>			50		Ω
Control (CTRL) high logic	CTRL <sub>H</sub>		1.2			V
CTRL low logic	CTRL <sub>L</sub>				0.4	V
CTRL input current	I <sub>CTRL</sub>	V <sub>CTRL</sub> = 3.6V		1		nA
		V <sub>CTRL</sub> = 0		0		
		V <sub>EN</sub> = 0V		0		
CTRL turn-on delay	t <sub>D</sub>			300		μs
CTRL pull-down resistor	R <sub>PD</sub>	Not present when CTRL is high to avoid I <sub>Q</sub> impact		2		MΩ
Power good (PG) threshold	PG	Feedback with respect to the regulation		90		%
PG hysteresis	PG <sub>HYS</sub>			10		%
PG delay	PG <sub>TD</sub>			75		μs
PG sink current capability	V <sub>PG_LO</sub>	Sink 1mA			0.4	V
PG leakage current	I <sub>PGLK</sub>	V <sub>PGBUS</sub> = 1.8V			10	nA
Thermal shutdown <sup>(7)</sup>	T <sub>SD</sub>			150		°C
Thermal hysteresis <sup>(7)</sup>	T <sub>SDHY</sub>			30		°C

**Notes:**

- 6) Not tested in production. Guaranteed by over-temperature correlation.  
7) Guaranteed by engineering sample characterization.

## TYPICAL PERFORMANCE CHARACTERISTICS

$V_{IN1} = 3.6V$ ,  $V_{OUT1} = 1.8V$ ,  $L_1 = 2.2\mu H$ ,  $C_{IN1} = 10\mu F$ ,  $C_{OUT1} = 10\mu F$ ,  $V_{IN2} = 3.6V$ ,  $V_{OUT2} = 1.8V$ ,  $C_{IN2} = 1\mu F$ ,  $C_{OUT2} = 1\mu F$ ,  $T_A = 25^\circ C$ , unless otherwise noted.

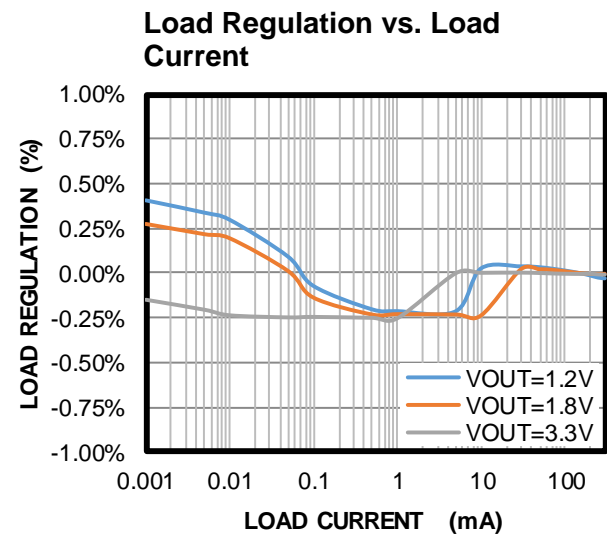
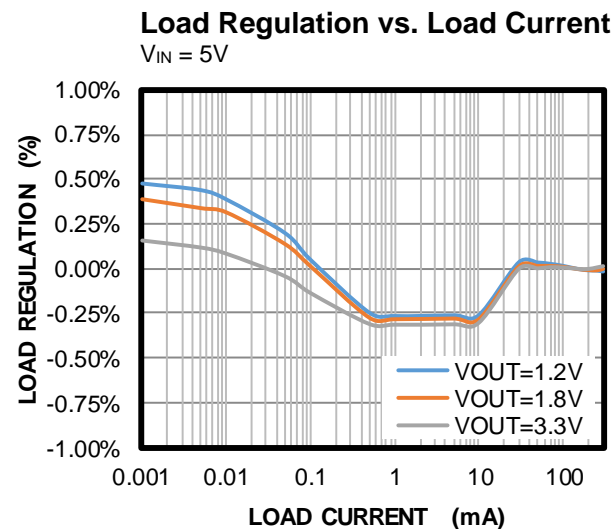
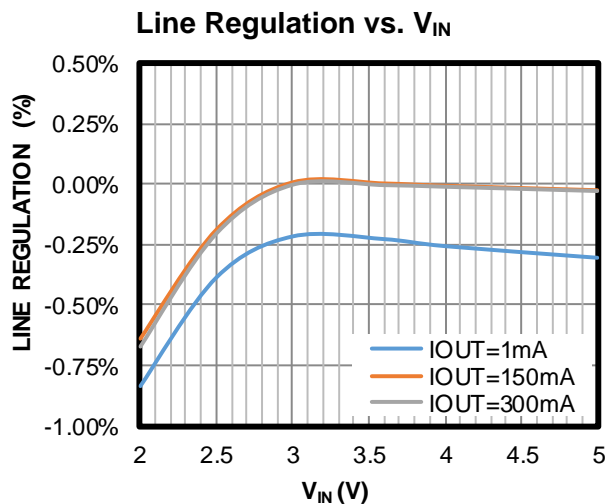
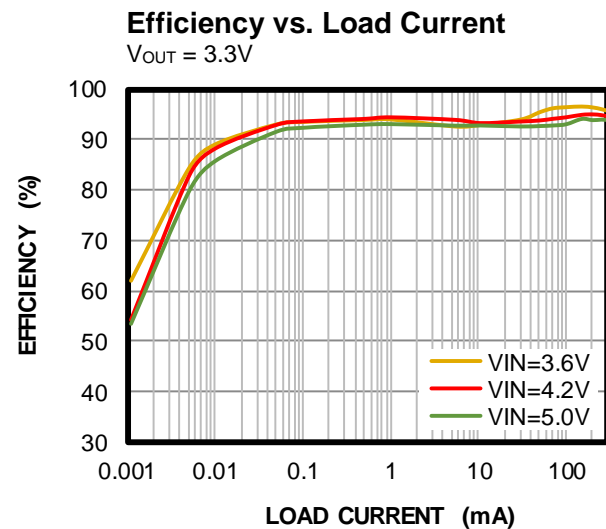
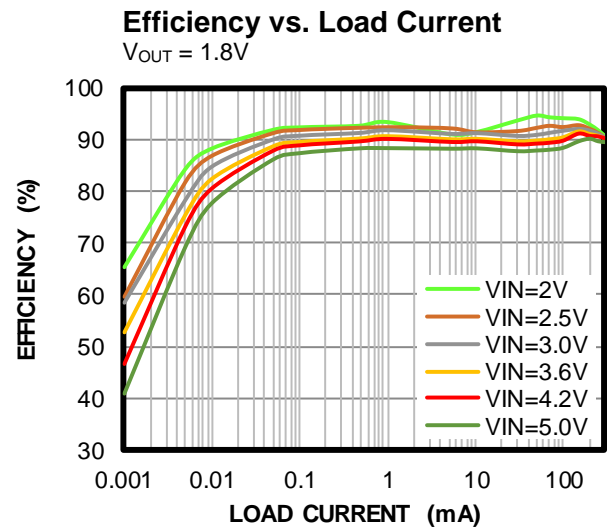
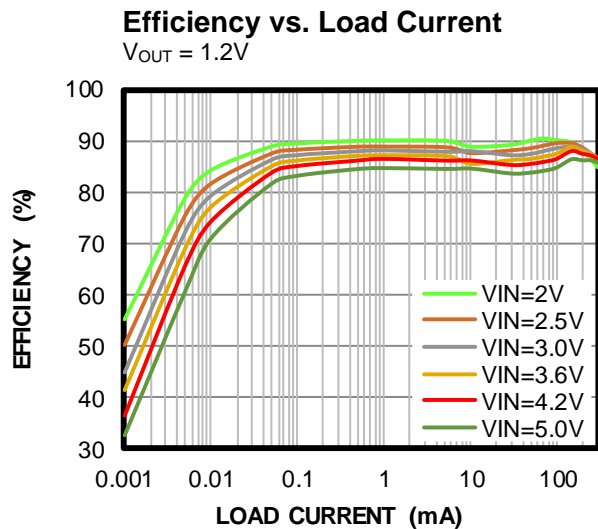

**TYPICAL PERFORMANCE CHARACTERISTICS (continued)**

$V_{IN1} = 3.6V$ ,  $V_{OUT1} = 1.8V$ ,  $L_1 = 2.2\mu H$ ,  $C_{IN1} = 10\mu F$ ,  $C_{OUT1} = 10\mu F$ ,  $V_{IN2} = 3.6V$ ,  $V_{OUT2} = 1.8V$ ,  $C_{IN2} = 1\mu F$ ,  $C_{OUT2} = 1\mu F$ ,  $T_A = 25^\circ C$ , unless otherwise noted.

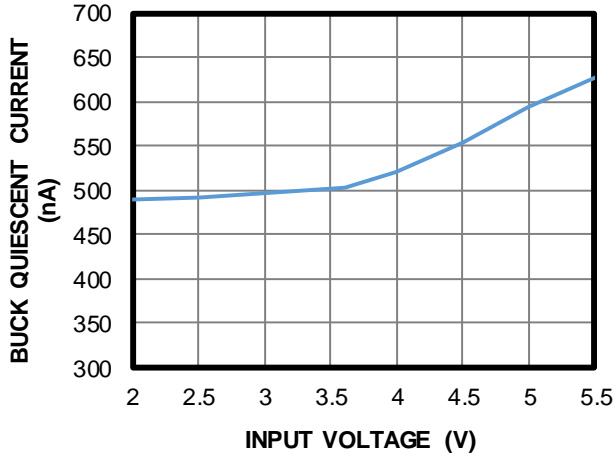
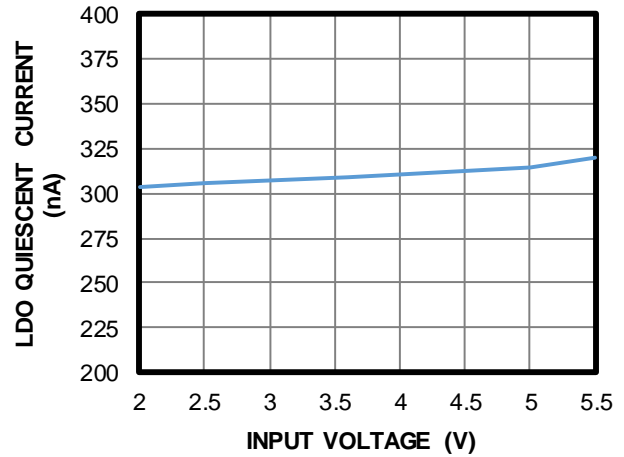
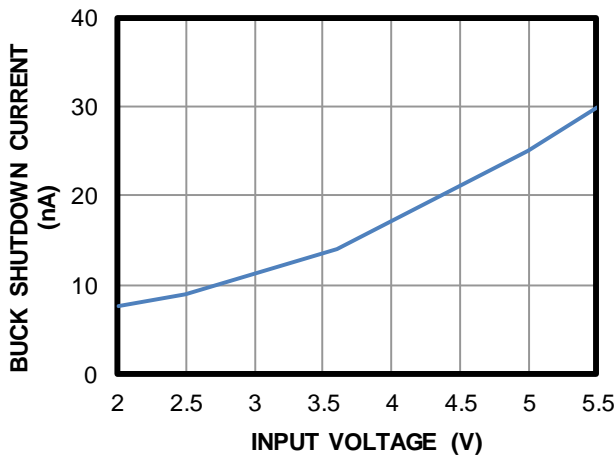
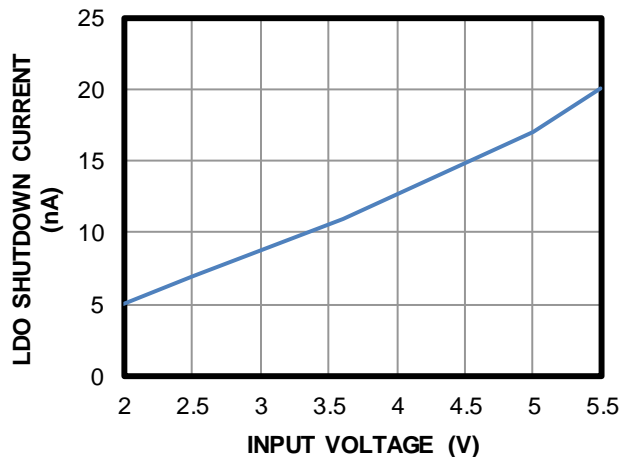
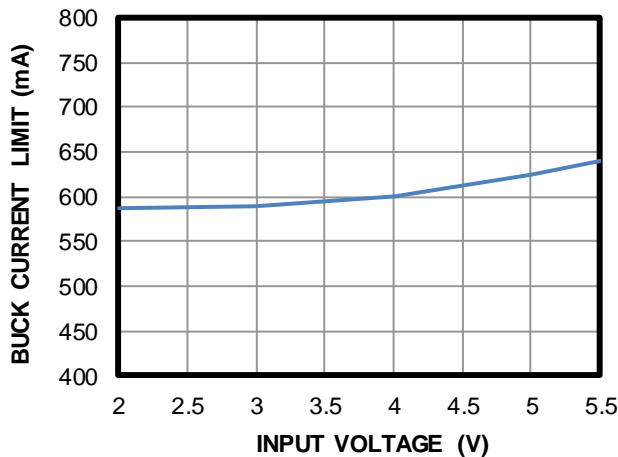
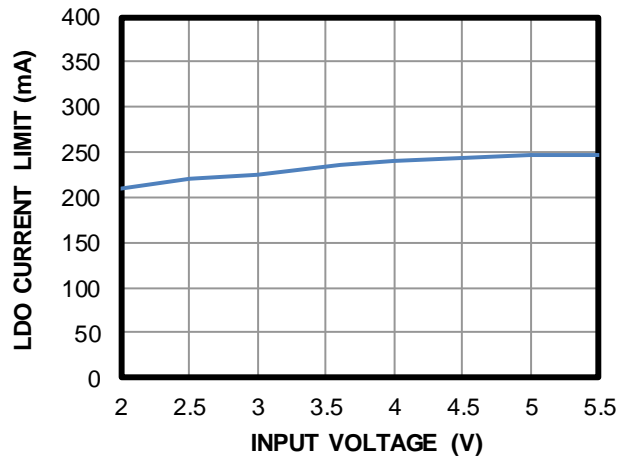
**Buck Quiescent Current vs.  $V_{IN}$** 

**LDO Quiescent Current vs.  $V_{IN}$** 

**Buck Shutdown Current vs.  $V_{IN}$**   
 CTRL1/2/3 = 0V

**LDO Shutdown Current vs.  $V_{IN}$**   
 CTRL4/5 = 0V

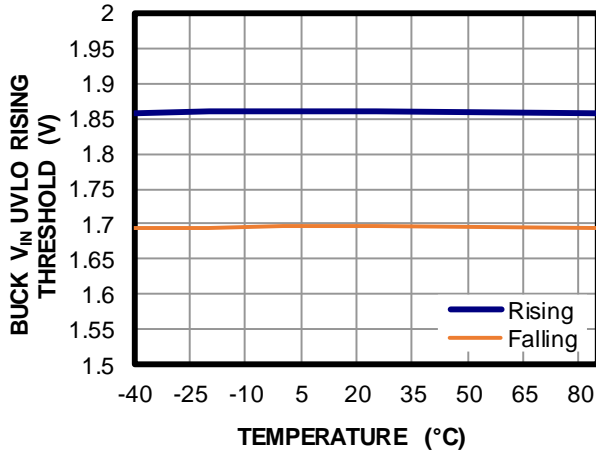
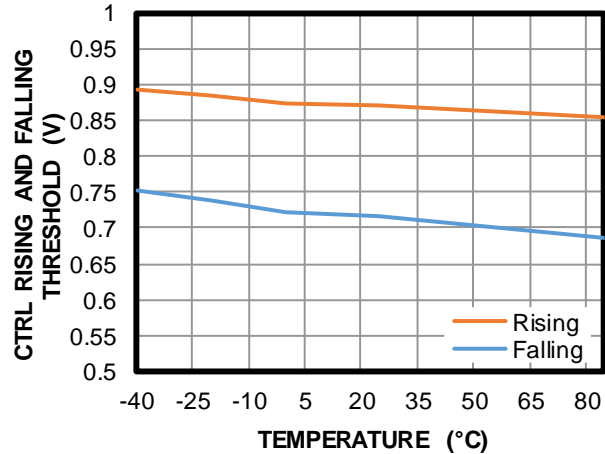
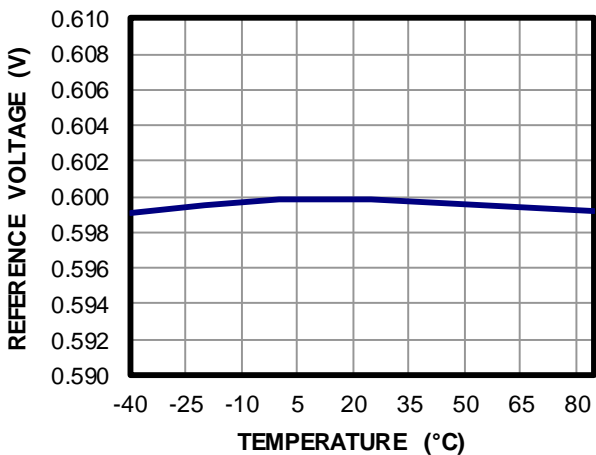
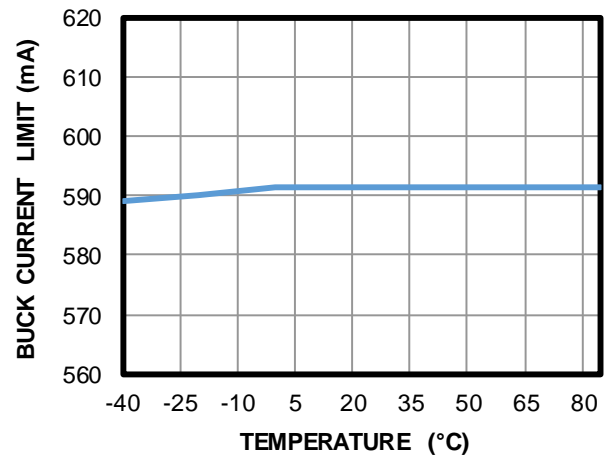
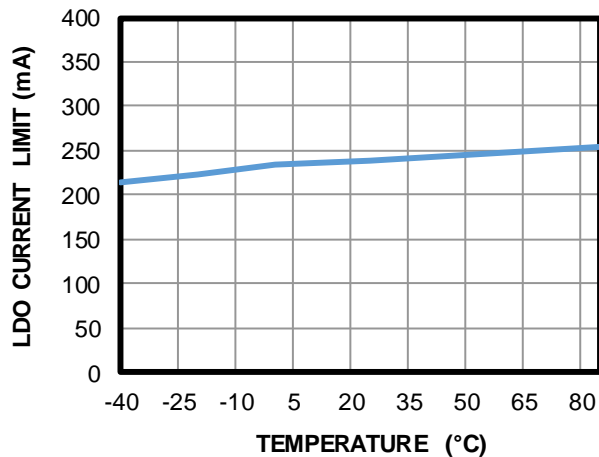
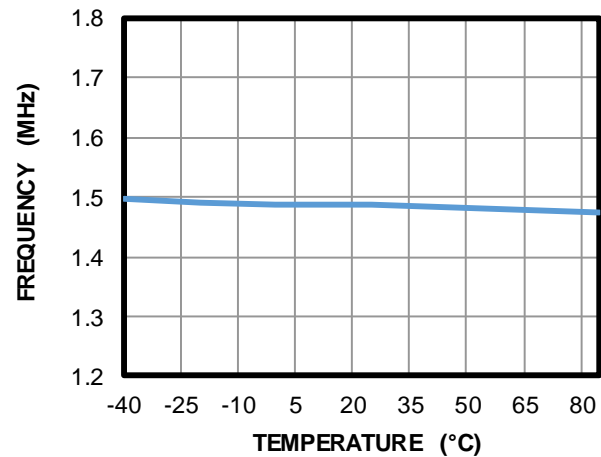
**Buck Current Limit vs.  $V_{IN}$** 

**LDO Current Limit vs.  $V_{IN}$** 



**TYPICAL PERFORMANCE CHARACTERISTICS (continued)**

V<sub>IN1</sub> = 3.6V, V<sub>OUT1</sub> = 1.8V, L<sub>1</sub> = 2.2μH, C<sub>IN1</sub> = 10μF, C<sub>OUT1</sub> = 10μF, V<sub>IN2</sub> = 3.6V, V<sub>OUT2</sub> = 1.8V, C<sub>IN2</sub> = 1μF, C<sub>OUT2</sub> = 1μF, T<sub>A</sub> = 25°C, unless otherwise noted.

**Buck V<sub>IN</sub> UVLO Rising Threshold vs. Temp**

**CTRL Rising and Falling Threshold vs. Temp**

**Reference Voltage vs. Temp**

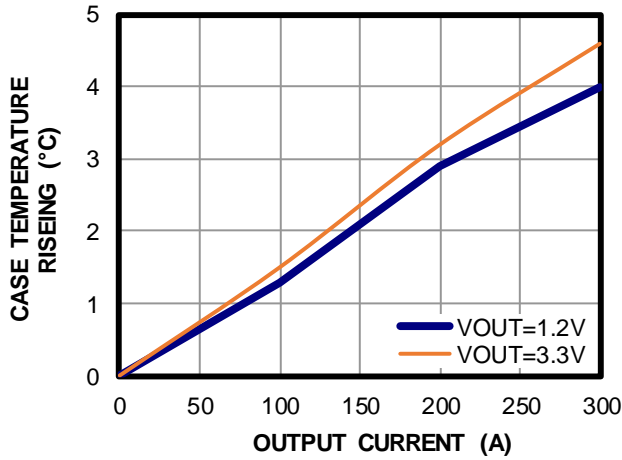
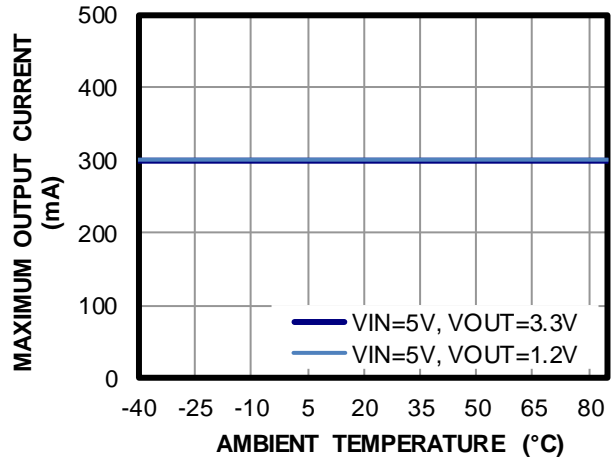
**Buck Current Limit vs. Temp**

**LDO Current Limit vs. Temp**

**Frequency vs. Temp**

**TYPICAL PERFORMANCE CHARACTERISTICS (continued)**

$V_{IN1} = 3.6V$ ,  $V_{OUT1} = 1.8V$ ,  $L_1 = 2.2\mu H$ ,  $C_{IN1} = 10\mu F$ ,  $C_{OUT1} = 10\mu F$ ,  $V_{IN2} = 3.6V$ ,  $V_{OUT2} = 1.8V$ ,  $C_{IN2} = 1\mu F$ ,  $C_{OUT2} = 1\mu F$ ,  $T_A = 25^\circ C$ , unless otherwise noted.

**Case Temp Rising vs. Output Current**
 $V_{IN} = 5V$ 

**Maximum Output Current vs. Ambient Temp**
 $T_J \leq 125^\circ C$ 

**TYPICAL PERFORMANCE CHARACTERISTICS (continued)**

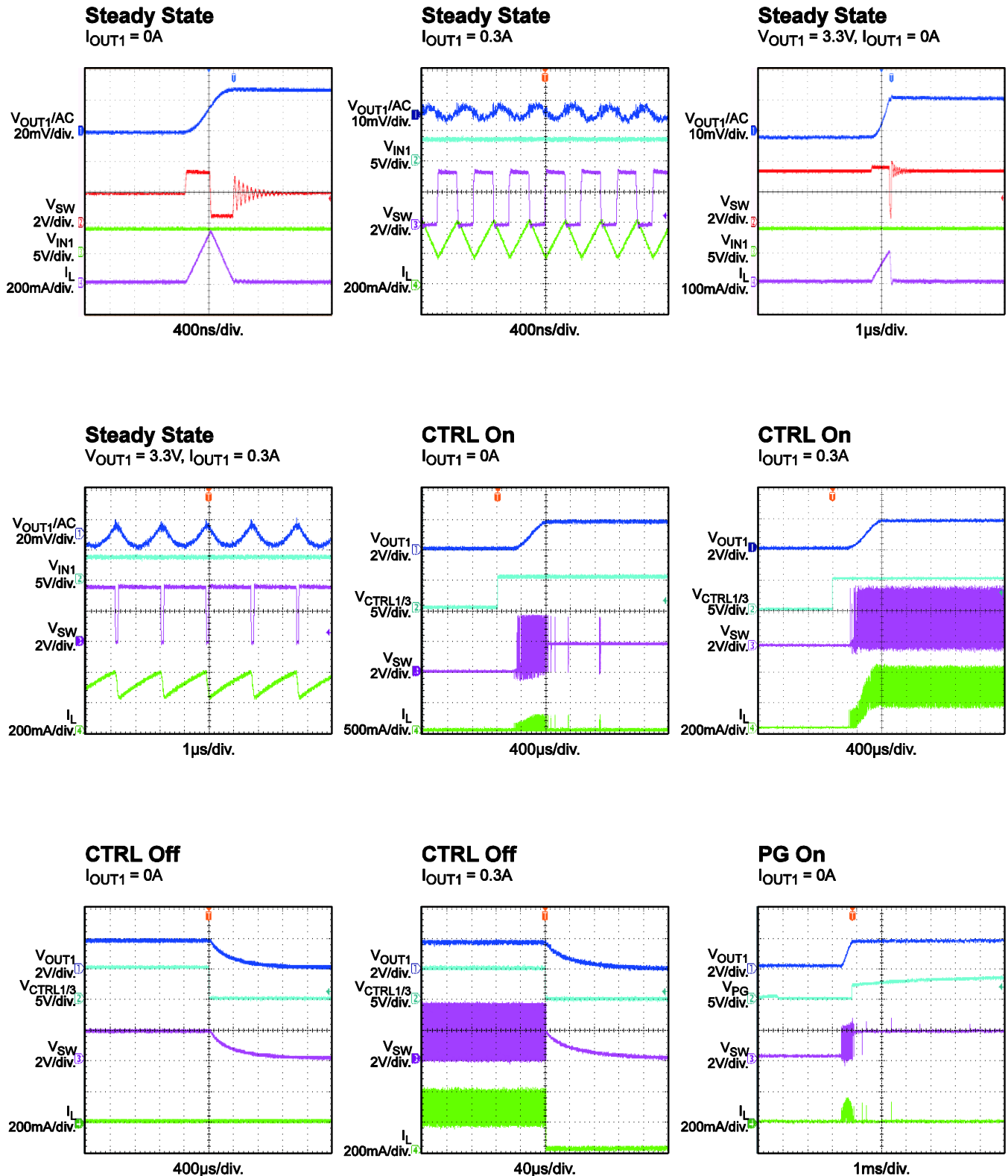
$V_{IN1} = 3.6V$ ,  $V_{OUT1} = 1.8V$ ,  $L_1 = 2.2\mu H$ ,  $C_{IN1} = 10\mu F$ ,  $C_{OUT1} = 10\mu F$ ,  $V_{IN2} = 3.6V$ ,  $V_{OUT2} = 1.8V$ ,  $C_{IN2} = 1\mu F$ ,  $C_{OUT2} = 1\mu F$ ,  $T_A = 25^\circ C$ , unless otherwise noted.



**TYPICAL PERFORMANCE CHARACTERISTICS (continued)**

$V_{IN1} = 3.6V$ ,  $V_{OUT1} = 1.8V$ ,  $L_1 = 2.2\mu H$ ,  $C_{IN1} = 10\mu F$ ,  $C_{OUT1} = 10\mu F$ ,  $V_{IN2} = 3.6V$ ,  $V_{OUT2} = 1.8V$ ,  $C_{IN2} = 1\mu F$ ,  $C_{OUT2} = 1\mu F$ ,  $T_A = 25^\circ C$ , unless otherwise noted.

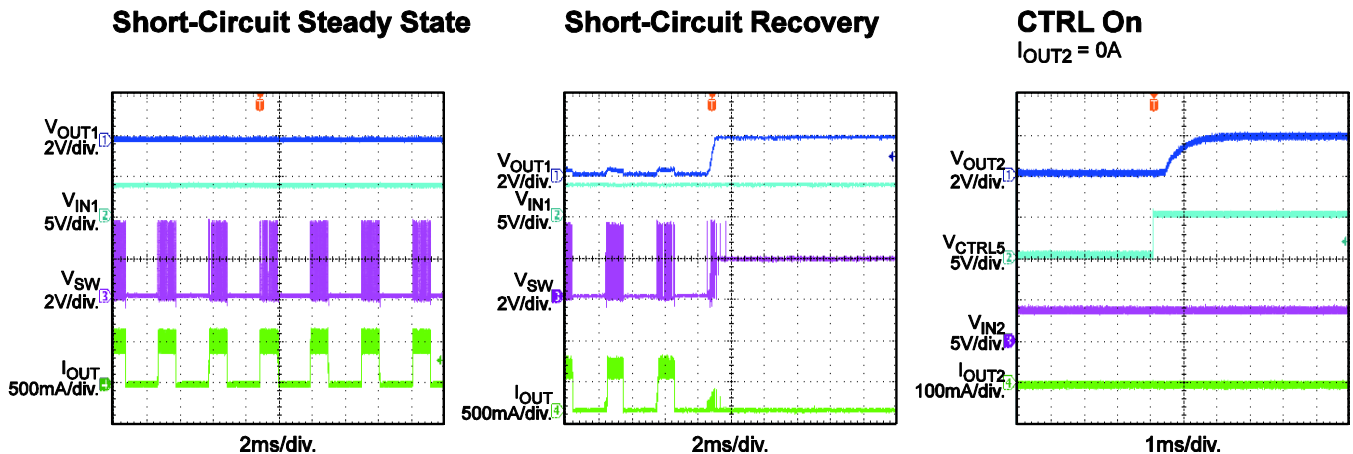
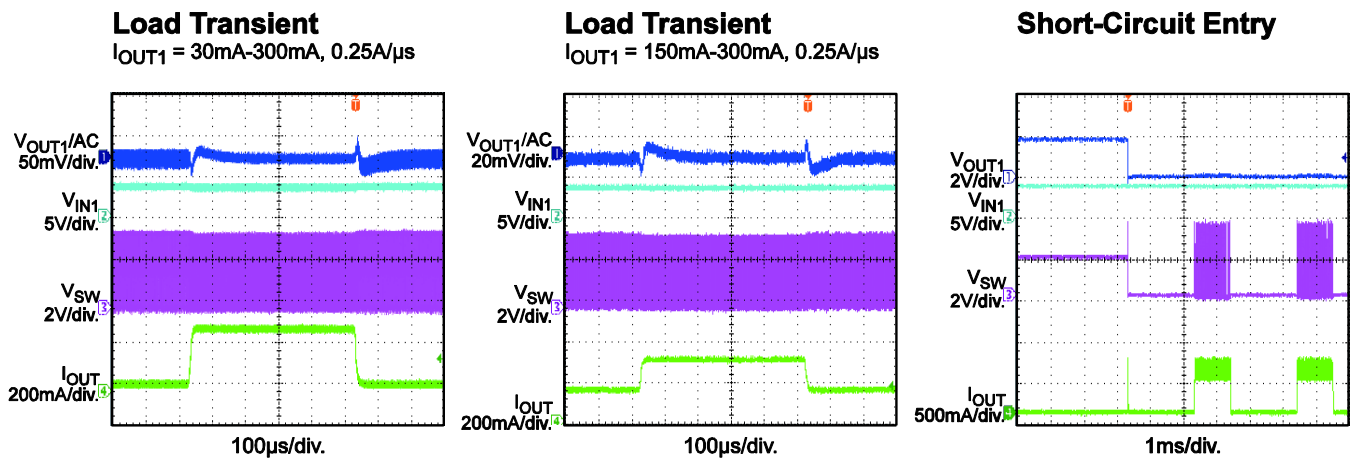
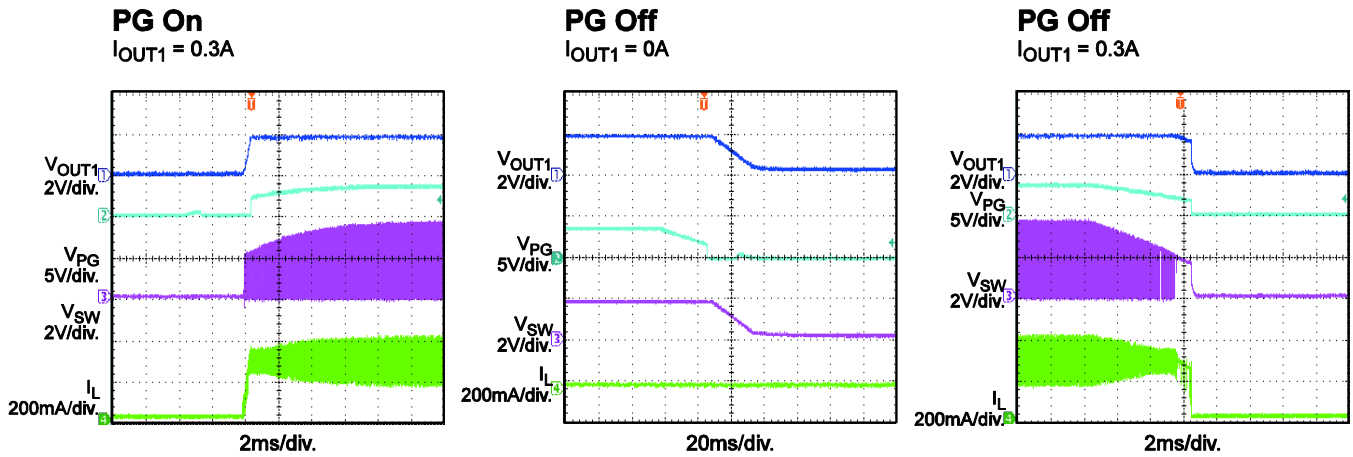

**TYPICAL PERFORMANCE CHARACTERISTICS (continued)**

$V_{IN1} = 3.6V$ ,  $V_{OUT1} = 1.8V$ ,  $L_1 = 2.2\mu H$ ,  $C_{IN1} = 10\mu F$ ,  $C_{OUT1} = 10\mu F$ ,  $V_{IN2} = 3.6V$ ,  $V_{OUT2} = 1.8V$ ,  $C_{IN2} = 1\mu F$ ,  $C_{OUT2} = 1\mu F$ ,  $T_A = 25^\circ C$ , unless otherwise noted.

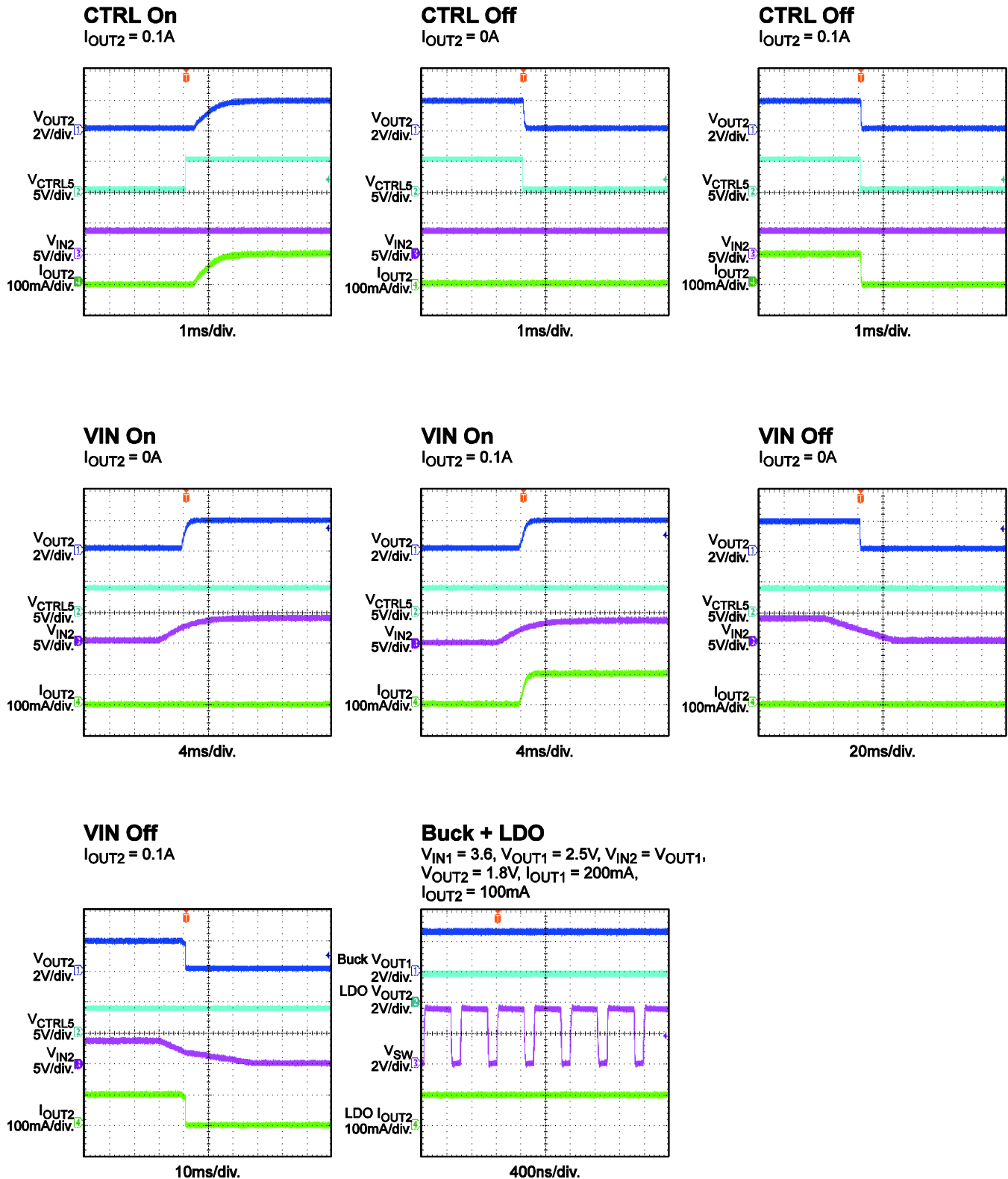

## FUNCTIONAL BLOCK DIAGRAM

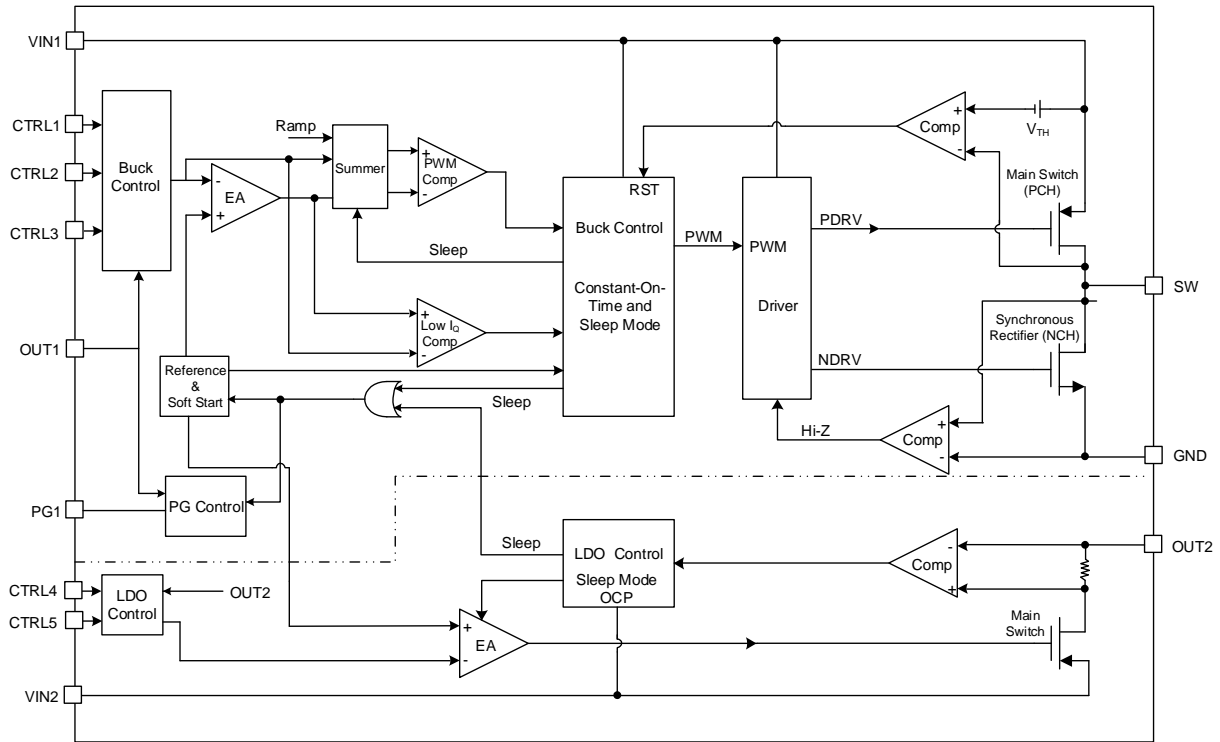

Figure 1: Functional Block Diagram

## OPERATION

The MP28310 is a monolithic power management unit containing a step-down converter with an ultra-low quiescent current ( $I_Q$ ) and a low-dropout (LDO) regulator. The step-down converter has 500nA of  $I_Q$ , allowing the MP28310 to achieve extremely high efficiency under ultra-light load conditions. The 300nA low- $I_Q$  LDO provides easy system configuration.

### Buck Constant-On-Time (COT) Control

The MP28310 uses constant-on-time (COT) control to regulate the output voltage ( $V_{OUT}$ ) and stabilize the switching frequency (typically 1.5MHz) across the full input voltage ( $V_{IN}$ ) range. The one-shot on-timer is controlled by  $V_{IN}$  and  $V_{OUT}$ . COT control allows the device to achieve a low output ripple and fast load transient response. COT control enables the use of output and input capacitors with lower capacitance. The MP28310 automatically enters pulse-skip mode (PSM) when the low-side MOSFET (LS-FET) current reaches 0A. PSM improves light-load efficiency. COT control provides a seamless transition between pulse-width modulation (PWM) mode and pulse-frequency modulation (PFM) mode.

### Light-Load Operation

If the load current decreases and the LS-FET current reaches 0A, both the high-side MOSFET (HS-FET) and LS-FET turn off. The output capacitors provide output energy during this period until  $V_{OUT}$  drops to the regulation voltage and triggers another on pulse.

Typically, the switching frequency during PFM mode depends on the load current. The switching frequency is lower when the load current is lighter. With PFM mode under light load, plus the ultra-low  $I_Q$  operation current, the MP28310 can achieve the highest efficiency during extremely light-load operation. This extends the charge cycle of any battery-powered system.

The buck needs a minimum of 5 $\mu$ s to exit light-load operation. When a large, sharp load increase occurs during light-load operation,  $V_{OUT}$  decreases as the buck exits light-load operation. The LDO exits light-load operation after a load exceeds 20mA.

### Control (CTRL)

The Control 1, Control 2, and Control 3 pins (CTRL1/2/3) control the start-up parameters and set  $V_{OUT}$  of the step-down converter. When CTRL1/2/3 are low, the MP28310's step-down converter turns off. If one of the CTRL1/2/3 pins is pulled high, the converter turns on. The step-down converter's set  $V_{OUT}$  is configurable, and is based on which CTRL1/2/3 pin is pulled high.

When the Control 4 and Control 5 pins (CTRL4/5) are low, the LDO turns off. If one of the CTRL4/5 pins is pulled high, the regulator turns on. The LDO's set  $V_{OUT}$  is configurable, and is based on which CTRL4/5 pin is pulled high.

Table 1 shows the programmable output voltages for all CTRL pins.

**Table 1: CTRL Pins vs. Output Voltages**

Step-Down Converter			
CTRL3	CTRL2	CTRL1	OUT1
0	0	0	Disabled
0	0	1	1.2V
0	1	0	1.5V
0	1	1	1.8V
1	0	0	2.5V
1	0	1	2.8V
1	1	0	3.0V
1	1	1	3.3V
LDO			
CTRL5		CTRL4	OUT2
0		0	Disabled
0		1	1.8V
1		0	2.8V
1		1	3.0V

$V_{OUT}$  can be configured during normal operation, and supports dynamic  $V_{OUT}$  scaling. Do not float the CTRL pins. Any used CTRL voltage must not be below  $V_{IN}$ , and any unused CTRL pin must be tied to GND.

### Soft Start (SS)

When the converter turns on, the internal reference starts up. After a set delay time, the device enters soft start (SS). The step-down converter  $V_{OUT}$  reaches the regulation voltage in about 0.5ms. The LDO's SS time is about 2ms when  $V_{OUT2}$  is 3.3V and  $C_{OUT2}$  is 1 $\mu$ F.

### Power Good (PG) Indicators for the Buck Converter

The MP28310 has an open-drain output power good (PG) indicator with a maximum  $R_{DS(ON)}$  of 400 $\Omega$ . The PG pin requires a 100k $\Omega$  to 500k $\Omega$  external pull-up resistor for PG indication. This resistor can be pulled up to  $V_{IN}$  or tied to CTRL if the CTRL voltages do not need to be adjusted dynamically.

The PG comparator is active when the device is on. The comparator is driven to a high impedance if  $V_{OUT}$  reaches the PG threshold (typically 90% of the regulation voltage). It is pulled low if  $V_{OUT}$  drops below the PG hysteresis threshold (typically 80% of the regulation voltage).  $V_{OUT}$  is also pulled low if  $V_{IN}$  is lost or the part turns off.

### Output Discharge Function

The step-down converter and LDO feature an output discharge function. Once the step-down converter is off, it utilizes the output discharge function. This function prevents residual charge voltages on the capacitors, which may impact a proper system start-up. Output discharge is active when  $V_{IN}$  is high and the related converters are off.

### 100% Duty Cycle Mode

When  $V_{IN}$  drops below the regulation output voltage,  $V_{OUT}$  drops and the on time increases. Reducing  $V_{IN}$  further drives the MP28310 into 100% duty cycle mode. The HS-FET is always on, and  $V_{OUT}$  is determined by the load current multiplied by  $R_{DS(ON)}$ , which is determined by the HS-FET and inductor.

### Low-Dropout (LDO) Mode

The low-dropout (LDO) regulator turns on once CTRL4 or CTRL5 pulls high and  $V_{IN1}$ 's input voltage ( $V_{IN1}$ ) reaches the UVLO threshold. CTRL4/5 can be programmed to select one of three preset output voltages.

### Current Limit

The MP28310's step-down converter and LDO each have an internal current limit.

The HS-FET current is monitored cycle by cycle and compared to the current-limit threshold. Once the current-limit comparator is triggered, the HS-FET turns off and the LS-FET turns on, reducing the inductor current. The HS-FET cannot turn on again until the LS-FET current drops below the low-side current limit.

If the LDO current reaches its current limit, the LDO current clamps at the current limit and output regulation stops.

### Short Circuit and Recovery

If the buck converter's  $V_{OUT}$  is shorted to GND, the current limit is triggered. If the current limit is triggered every cycle for 200 $\mu$ s, the MP28310's buck converter enters hiccup mode.

The short-circuit condition is also triggered if  $V_{OUT}$  drops below 50% of the regulation  $V_{OUT}$  as the device reaches the current limit. The buck converter disables the output power stage, discharges  $V_{OUT}$ , and then attempts to recover after hiccup mode. If the short-circuit condition remains, the MP28310 repeats this operation until the short circuit is removed and  $V_{OUT}$  returns to its regulation level.

When a short circuit occurs in the LDO, the short-circuit protection (SCP) mechanism is similar to the over-current protection (OCP) mechanism. The current is clamped at the LDO current limit level.

### Thermal Shutdown Circuit and Recovery

If the thermal shutdown signal is triggered, the MP28310 turns off immediately. Once the temperature returns to below the thermal hysteresis threshold, the device restarts and resumes normal operation.



## APPLICATION INFORMATION

### Selecting the Inductor

Most applications work best with a 1μH to 2.2μH inductor. Select an inductor with a DC resistance below 200mΩ to optimize efficiency.

High-frequency, switch-mode power supplies with magnetic devices create strong electromagnetic interference (EMI) in the system. Unshielded power inductors should be avoided since they have poor magnetic shielding. Metal alloy or multilayer chip power shield inductors are recommended in application, as they effectively decrease EMI influence. Table 2 lists our inductor recommendations. Select a part number based on your design requirements.

**Table 2: Recommended Inductors**

Inductance	Manufacturer P/N	Package	Manufacturer
2.2μH	DFE201612P-2R2M	2016	Tokyo
2.2μH	74479775222A	2012	Würth

For most designs, the inductance value can be calculated with Equation (1):

$$L_1 = \frac{V_{OUT} \times (V_{IN} - V_{OUT})}{V_{IN} \times \Delta I_L \times f_{OSC}} \quad (1)$$

Where  $\Delta I_L$  is the inductor ripple current.

Choose the inductor current to be approximately 30% of the maximum load current. The maximum inductor peak current can be calculated with Equation (2):

$$I_{L(MAX)} = I_{LOAD} + \frac{\Delta I_L}{2} \quad (2)$$

### Input Capacitor Selection

The input capacitor reduces the surge current drawn from the input, as well as the switching noise from the device. Select an input capacitor with a switching frequency impedance below the input source impedance to prevent high-frequency switching current from passing through the input source. It is recommended to use low-ESR ceramic capacitors with X5R or X7R dielectrics due to their small temperature coefficients. For most applications, a 10μF capacitor is sufficient.

The input capacitor requires an adequate ripple current rating to absorb the input switching current.

The RMS current in the input capacitor can be estimated with Equation (3):

$$I_{C1} = I_{LOAD} \times \sqrt{\frac{V_{OUT}}{V_{IN}} \times \left(1 - \frac{V_{OUT}}{V_{IN}}\right)} \quad (3)$$

The worst-case scenario occurs when  $V_{IN} = 2V_{OUT}$ , and can be calculated with Equation (4):

$$I_{C1} = \frac{I_{LOAD}}{2} \quad (4)$$

For simplification, choose an input capacitor with an RMS current rating greater than half of the maximum load current.

The input capacitor can be electrolytic, tantalum, or ceramic. When using electrolytic or tantalum capacitors, add a small, high-quality, 0.1μF, ceramic capacitor as close to the IC as possible. When using ceramic capacitors, ensure that they have enough capacitance to provide a sufficient charge to prevent excessive voltage ripple at the input. The input voltage ripple caused by the capacitance can be estimated with Equation (5):

$$\Delta V_{IN} = \frac{I_{LOAD}}{f_s \times C1} \times \frac{V_{OUT}}{V_{IN}} \times \left(1 - \frac{V_{OUT}}{V_{IN}}\right) \quad (5)$$

### Output Capacitor Selection

The output capacitor limits the output voltage ripple and ensures a stable regulation loop. Select an output capacitor with low impedance at the switching frequency. For most applications, a 10μF capacitor is sufficient. The output voltage ripple can be calculated with Equation (6):

$$\Delta V_{OUT} = \frac{V_{OUT}}{f_s \times L_1} \times \left(1 - \frac{V_{OUT}}{V_{IN}}\right) \times \left(R_{ESR} + \frac{1}{8 \times f_s \times C2}\right) \quad (6)$$

Where  $L_1$  is the inductor value, and  $R_{ESR}$  is the equivalent series resistance (ESR) value of the output capacitor.

When using ceramic capacitors, the capacitance dominates the impedance at the switching frequency and causes most of the output voltage ripple.

For simplification, the output voltage ripple can be estimated with Equation (7):

$$\Delta V_{OUT} = \frac{V_{OUT}}{8 \times f_s^2 \times L_1 \times C_2} \times \left( 1 - \frac{V_{OUT}}{V_{IN}} \right) \quad (7)$$

The characteristics of the output capacitor also affect the stability of the regulation system.

**PCB Layout Guidelines**

Designing an efficient PCB layout for the switching power supply, especially the high switching frequency converter, is critical for

stable operation. Without careful placement, the regulator could exhibit poor line or load regulation and stability issues.

For the best results, refer to Figure 2 and follow the guidelines below:

1. Place the input capacitor as close to the IC pins as possible. This helps the high-speed step-down regulator provide clean control voltage for the chip.
2. Place C<sub>IN1</sub> close to VIN1 and GND to absorb noise.

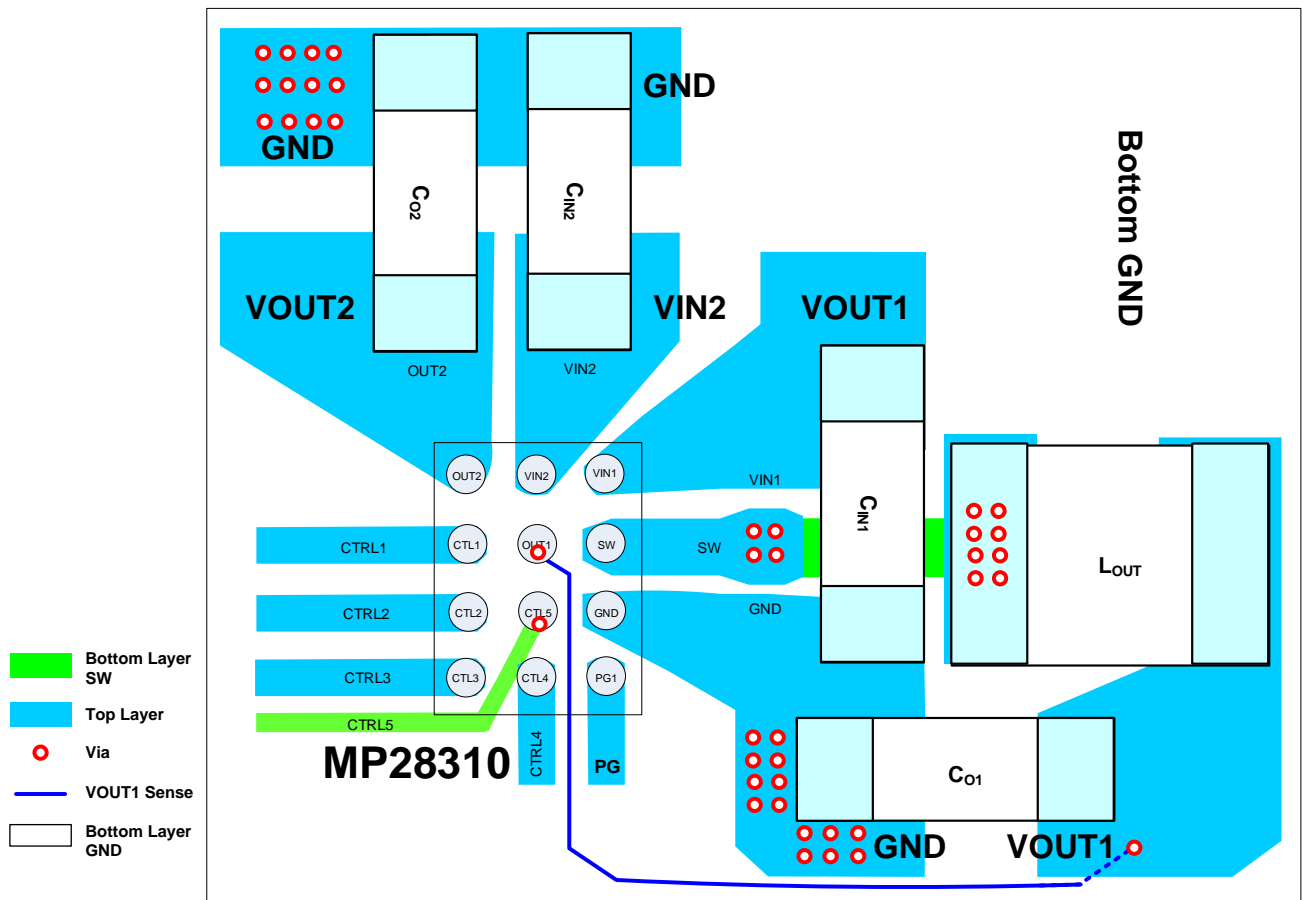
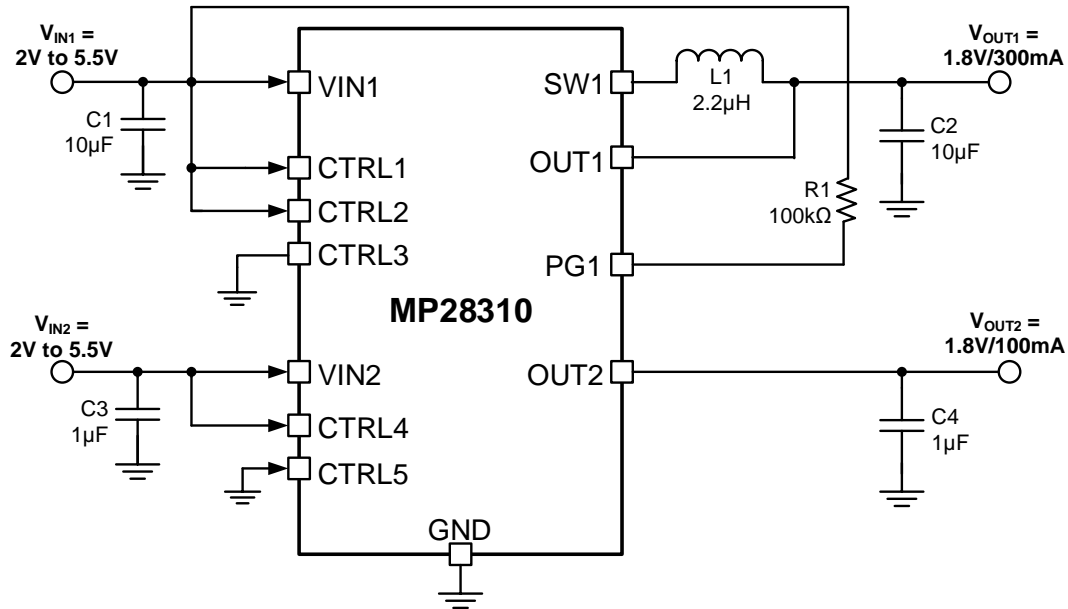
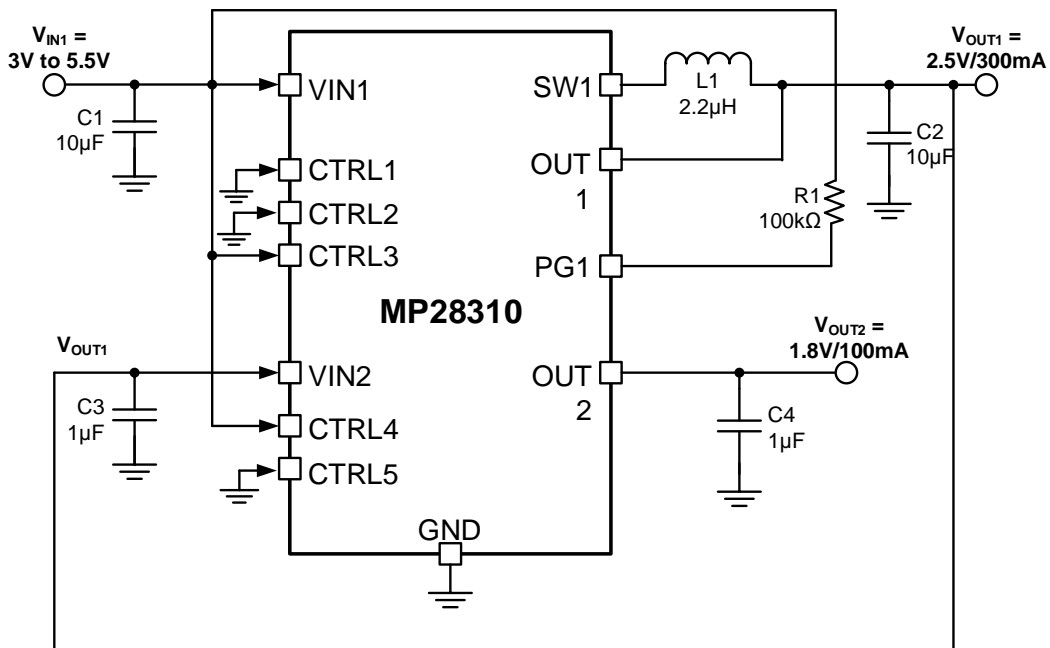

Figure 2: Recommended PCB Layout

## TYPICAL APPLICATION CIRCUITS

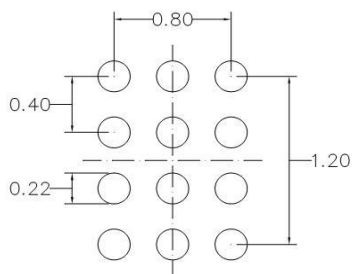
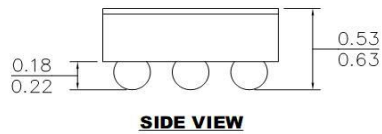
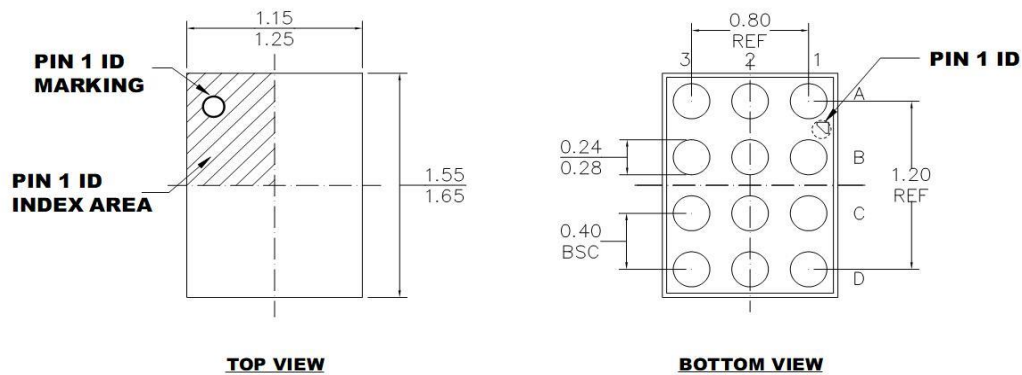

 Figure 3: Typical Application Circuit for MP28310GC <sup>(8)</sup>

 Figure 4: Buck and LDO in Sequence <sup>(9)</sup>

## Notes:

- 8) VIN1 and VIN2 have dependent power supplies. VIN1 must exceed the VIN under-voltage lockout (UVLO) threshold.
- 9) CTRL4/5 must be connected to VIN1 in sequence.

PACKAGE INFORMATION

CSP-12 (1.2mmx1.6mm)



**RECOMMENDED LAND PATTERN**

**NOTE:**

- 1) ALL DIMENSIONS ARE IN MILLIMETERS.
- 2) BALL COPLANARITY SHALL BE 0.05 MILLIMETER MAX.
- 3) JEDEC REFERENCE IS MO-211.
- 4) DRAWING IS NOT TO SCALE.

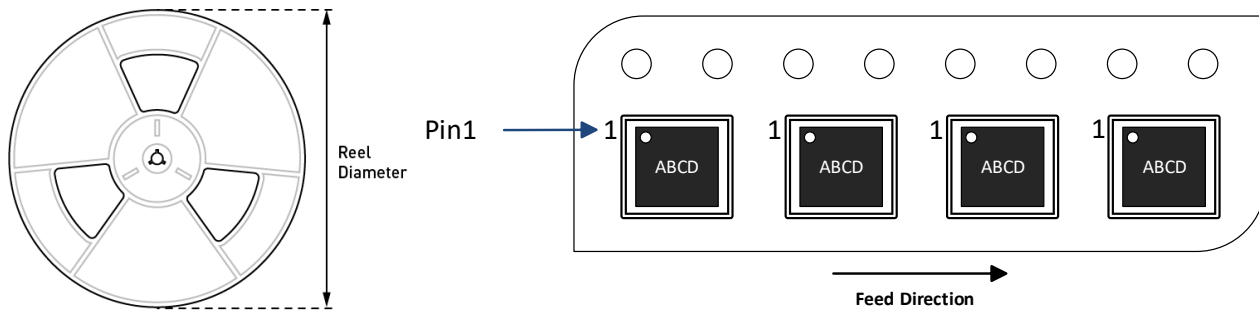
**CARRIER INFORMATION**

Part Number	Package Description	Quantity/ Reel	Quantity/ Tube	Reel Diameter	Carrier Tape Width	Carrier Tape Pitch
MP28310GC-Z	CSP-12 (1.2mmx1.6mm)	3000	N/A	7in	8mm	4mm

## REVISION HISTORY

Revision #	Revision Date	Description	Pages Updated
1.0	12/23/2020	Initial Release	-

**Notice:** The information in this document is subject to change without notice. Please contact MPS for current specifications. Users should warrant and guarantee that third-party Intellectual Property rights are not infringed upon when integrating MPS products into any application. MPS will not assume any legal responsibility for any said applications.