

APPLICATIONS



- Battery-powered devices
- High switching frequency SMPS
- IoT
- Wearable
- Portable devices
- Input filters

FEATURES

- Size 2.5mmx2.0mmx1.2mm
- Low Profile
- Low Audible Noise
- Molded Construction
- Soft Saturation
- Stable Over High Temperatures
- Low DCR
- Max Operating Temp +125°C
- RoHS/REACH-Compliant, Halogen-Free

ELECTRICAL CHARACTERISTICS

Parameter			Value	Unit
Inductance ⁽¹⁾	<i>L</i>	±20%	0.68	μH
Resistance	<i>R_{DC}</i>	Typ	23	mΩ
Resistance _{MAX}	<i>R_{DC MAX}</i>	Max	28	mΩ
Rated Current ⁽²⁾	<i>I_R</i>	Typ	4.8	A
Saturation Current _{25°C} ⁽³⁾	<i>I_{SAT 25°C}</i>	Typ	6	A
Saturation Current _{100°C} ⁽⁴⁾	<i>I_{SAT 100°C}</i>	Typ	6	A
Resonance Frequency	<i>f_r</i>	Typ	85	MHz

GENERAL SPECIFICATIONS

⁽¹⁾ Inductance	Measured at 100kHz, 100mA
⁽²⁾ Rated Current	Rated current will cause the coil temperature rise ΔT of 40K <i>I_R</i> measured with the inductor soldered in a single-layer PCB. Copper layer thickness 35μm Cu / PCB size 30x50mm. Temperature behavior dependent on circuit design, PCB layout, proximity to other components, and trace dimensions and thickness.
⁽³⁾ Saturation Current _{25°C}	Saturation current will cause L to drop from 30% at 25°C ambient temperature
⁽⁴⁾ Saturation Current _{100°C}	Saturation current will cause L to drop from 30% at 100°C ambient temperature
Temperature Test Condition	Electrical specifications measured at 25°C, 35% RH if not given differently
Operating Condition	Operating temperature: -40°C to +125°C (including temp rise) Should not exceed +125°C under worst-case operation conditions
Storage Condition	Tape and Reel packaging: -10°C to +40°C Humidity: <50% RH

All MPS parts are lead-free, halogen-free, and adhere to the RoHS directive. For MPS green status, please visit the MPS website under Quality Assurance. "MPS", the MPS logo, and "Simple, Easy Solutions" are registered trademarks of Monolithic Power Systems, Inc. or its subsidiaries.

TYPICAL PERFORMANCE CURVES

Temperature Rise vs. Current

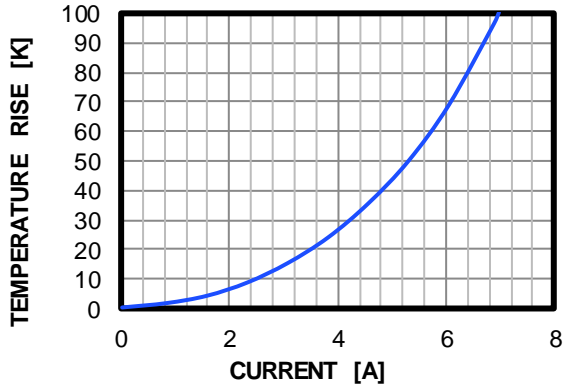

Inductance vs. Current

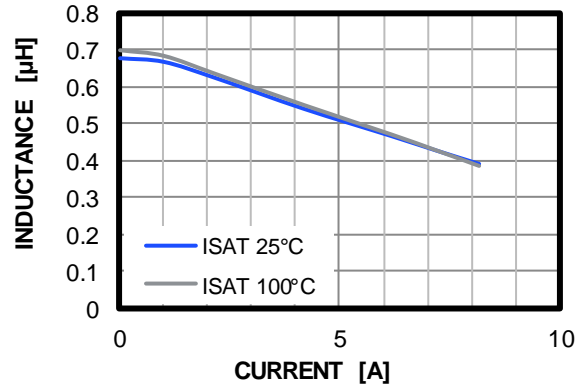

Impedance vs. Frequency

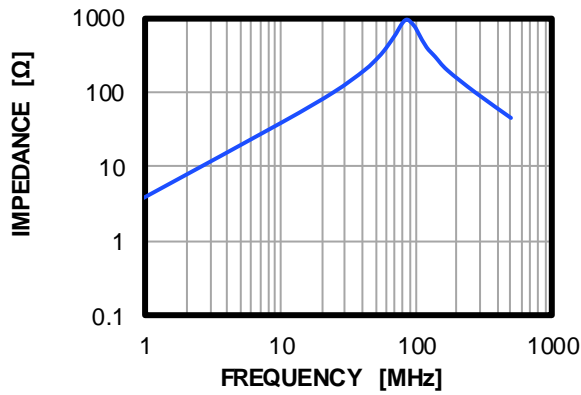

Inductance vs. Frequency

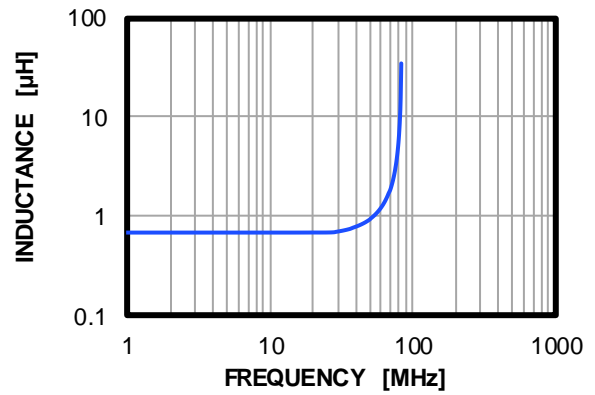

Quality Factor vs. Frequency

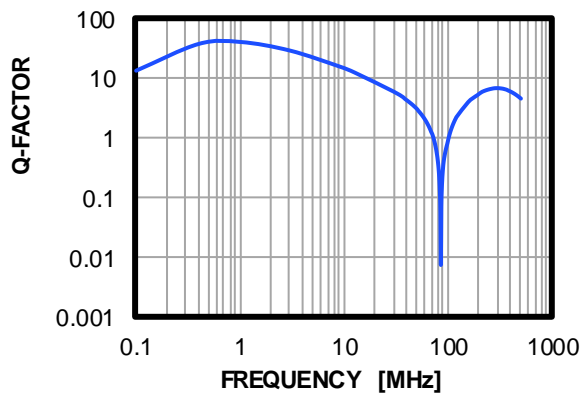

AC Resistance vs. Frequency

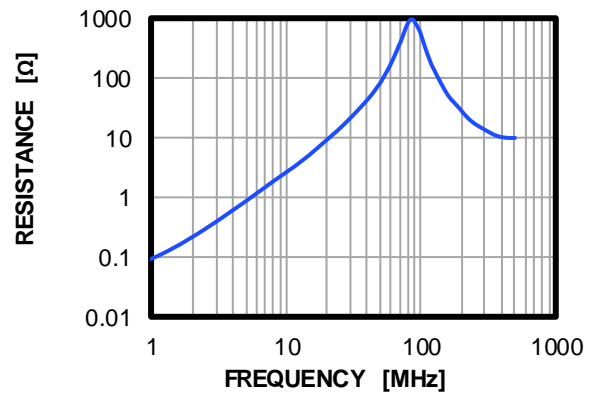

DIMENSIONS

PRODUCT PACKAGE

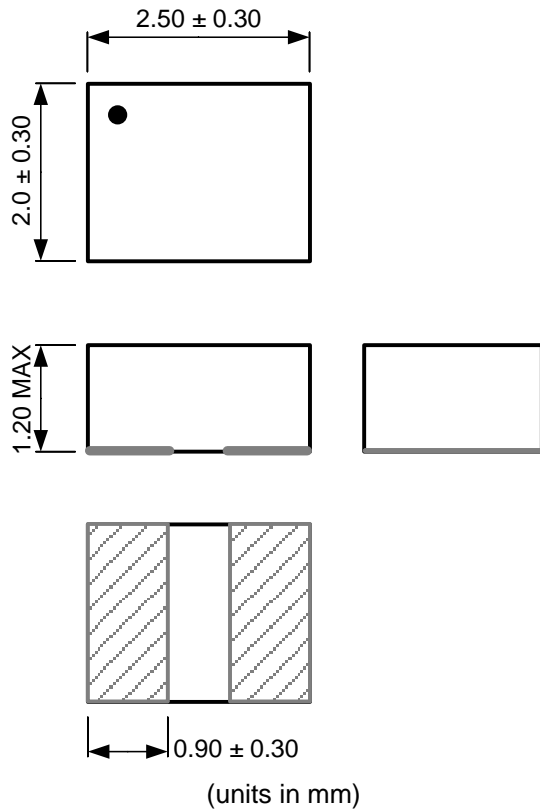

RECOMMENDED LAND PATTERN

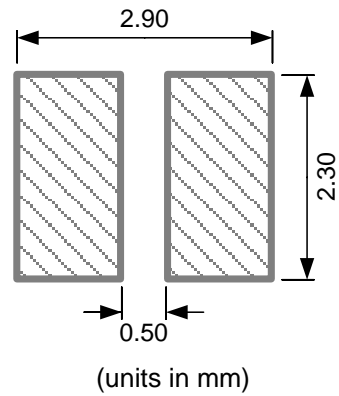

TOP MARKING

Marking

Start of Winding . (dot)

ORDERING INFORMATION

Part Number	$L^{(1)}$	R_{DC}	$I_R^{(2)}$	$I_{SAT\ 25^\circ C}^{(3)}$	$I_{SAT\ 100^\circ C}^{(4)}$
	±20% (μH)	Typ (mΩ)	Typ (A)	Typ (A)	Typ (A)
MPL-AT2512-R33	0.33	13	6.4	7.8	7.8
MPL-AT2512-R47	0.47	14	5.8	6.4	6.4
MPL-AT2512-R68	0.68	23	4.8	6	6
MPL-AT2512-1R0	1	33	4.1	5.2	5.2
MPL-AT2512-1R5	1.5	43	3.4	4.2	4.2
MPL-AT2512-2R2	2.2	68	2.8	3.4	3.4
MPL-AT2512-3R3	3.3	116	2.2	3	3
MPL-AT2512-4R7	4.7	170	1.8	2.4	2.4
MPL-AT2512-6R8	6.8	280	1.4	2.2	2.2
MPL-AT2512-100	10	355	1.2	1.7	1.7

GENERAL SPECIFICATIONS

(1) Inductance	Measured at 100kHz, 100mA
(2) Rated Current	Rated current will cause the coil temperature rise ΔT of 40K <i>I_R measured with the inductor soldered in a single-layer PCB. Copper layer thickness 35μm Cu / PCB size 30x50mm. Temperature behavior dependent on circuit design, PCB layout, proximity to other components, and trace dimensions and thickness.</i>
(3) Saturation Current $_{25^\circ C}$	Saturation current will cause L to drop from 30% at 25°C ambient temperature
(4) Saturation Current $_{100^\circ C}$	Saturation current will cause L to drop from 30% at 100°C ambient temperature
Temperature Test Condition	Electrical specifications measured at 25°C, 35% RH if not given differently
Operating Condition	Operating temperature: -40°C to +125°C (including temp rise) Should not exceed +125°C under worst-case operation conditions
Storage Condition	Tape and Reel packaging: -10°C to +40°C Humidity: <50% RH

REVISION HISTORY

Revision #	Revision Date	Description	Pages Updated
1.0	7/11/2019	Initial Release	-
1.1	8/1/2019	Updated Impedance vs. Frequency Curve	2
1.2	7/6/2023	Updated the R_{DC} (Typ), $R_{DC\ MAX}$, I_R (Typ), and f_r (Typ) values, and made minor formatting edits in the Electrical Characteristics section	1
		Updated all the Typical Performance Curves	2
		Reordered the Dimensions section; updated the Product Package and Recommended Land Pattern images	3
		Made minor formatting edits and updated the following values in the Ordering Information section: <ul style="list-style-type: none"> • Replaced the MPL-AT2514-2R2 and MPL-AT2514-4R7 with the MPL-AT2512-2R2 and MPL-AT2512-4R7, respectively • MPL-AT2512-R33: Updated R_{DC} (Typ), $I_{SAT\ 25^{\circ}C}$ (Typ), and $I_{SAT\ 100^{\circ}C}$ (Typ) • MPL-AT2512-R47: Updated R_{DC} (Typ) and I_R (Typ) • MPL-AT2512-R68: Updated R_{DC} (Typ) and I_R (Typ) • MPL-AT2512-1R0: Updated R_{DC} (Typ) and I_R (Typ) • MPL-AT2512-1R5: Updated R_{DC} (Typ) and I_R (Typ) • MPL-AT2512-3R3: Updated R_{DC} (Typ), I_R (Typ), $I_{SAT\ 25^{\circ}C}$ (Typ), and $I_{SAT\ 100^{\circ}C}$ (Typ) 	4

Notice: The information in this document is subject to change without notice. Please contact MPS for current specifications. Users should warrant and guarantee that third-party Intellectual Property rights are not infringed upon when integrating MPS products into any application. MPS will not assume any legal responsibility for any said applications.