

DESCRIPTION

The MPQ5074 provides up to 3A of load current (I_{LOAD}) across a 1.2V to 5.5V input voltage (V_{IN}) range. The low on resistance ($R_{DS(ON)}$) and tiny package make the MPQ5074 a highly efficient and space-saving solution for automotive infotainment systems, clusters, and advanced driver-assistance systems (ADAS).

The MPQ5074 employs soft start (SS) to reduce inrush current during circuit start up. It also features a configurable soft-start time (t_{SS}), output discharge, over-current protection (OCP) and thermal shutdown.

The maximum I_{LOAD} at the output (source) is current-limited by the sense FET topology. The current limit (I_{LIMIT}) magnitude is controlled by an external resistor connected between the ILIM pin and ground.

An internal charge pump drives the power device's gate, allowing for a 10m Ω low- $R_{DS(ON)}$ DMOS power MOSFET.

The MPQ5074 is available in a tiny QFN-13 (2.5mmx3mm) package.

FEATURES

- Guaranteed Industrial and Automotive Temperature
- Integrated 10m Ω Low- $R_{DS(ON)}$ MOSFETs
- Adjustable Start-Up Slew Rate
- Wide 1.2V to 5.5V Input Voltage (V_{IN}) Range
- <1 μ A Shutdown Current (I_{SD})
- 3A Configurable Current Limit (I_{LIMIT}) Range
- Output Discharge
- Enable (EN) Pin
- <200ns Short-Circuit Protection (SCP) Response
- Push-Pull Power Good (PG) Indication
- Thermal Shutdown
- Available in a Small, Space-Saving QFN-13 (2.5mmx3mm) Package
- Available in AEC-Q100 Grade 1

APPLICATIONS

- Automotive Infotainment Systems
- Automotive Clusters
- Automotive Advanced Driver-Assistance Systems (ADAS)
- Industrial Systems

All MPS parts are lead-free, halogen-free, and adhere to the RoHS directive. For MPS green status, please visit the MPS website under Quality Assurance. "MPS", the MPS logo, and "Simple, Easy Solutions" are trademarks of Monolithic Power Systems, Inc. or its subsidiaries.

TYPICAL APPLICATION

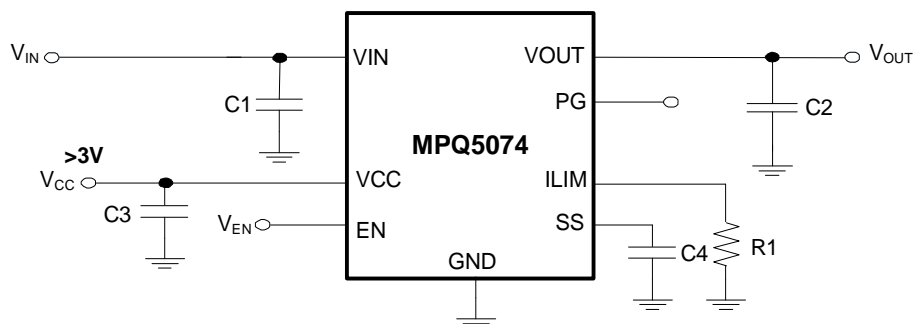

ORDERING INFORMATION

Part Number*	Package	Top Marking	MSL Rating
MPQ5074GQBE-AEC1	QFN-13 (2.5mmx3mm)	See Below	1

* For Tape & Reel, add suffix -Z (e.g. MPQ5074GQBE-AEC1-Z).

TOP MARKING

BTE

YWW

LLL

BTE: MPQ5074GQBE-AEC1

Y: Year code

WW: Week code

LLL: Lot number

PACKAGE REFERENCE

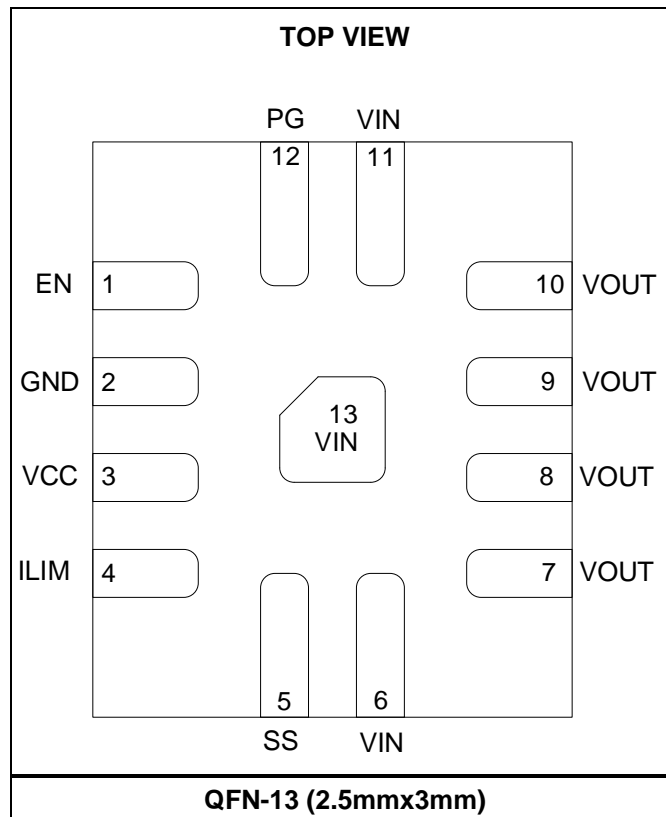

PIN FUNCTIONS

Pin #	Name	Description
1	EN	Enable. Pull the EN pin above 1.5V to turn the device on; pull EN to ground or float EN to turn it off.
2	GND	Ground.
3	VCC	Supply voltage. The VCC pin supplies power to the control circuitry.
4	ILIM	Output current limit setting. Connect a resistor between the ILIM pin and ground to set the output current limit (I _{LIMIT}) level.
5	SS	Soft start. An external capacitor connected to the SS pin sets the soft-start slew rate.
6, 11, 13	VIN	Input power supply.
7, 8, 9, 10	VOUT	Output to the load.
12	PG	Power good. The PG pin is a push-pull output that indicates whether the V _{IN} to V _{OUT} voltage gap has exceeded 200mV or an over-current limit warning was occurred.

ABSOLUTE MAXIMUM RATINGS ⁽¹⁾

V _{IN}	-0.3V to +6.5V
V _{CC}	-0.3V to +6.5V
V _{OUT}	-0.3V to +6.5V
V _{EN}	-0.3V to +6.5V
V _{SS} , V _{ILIM}	-0.3V to V _{CC} + 0.3V
Junction temperature (T _J)	150°C
Lead temperature	260°C
Continuous power dissipation ⁽²⁾	
QFN-13 (2.5mmx3mm)	2W

ESD Ratings

Human body model (HBM)	±2kV
Charged-device model (CDM)	±750V

Recommended Operating Conditions ⁽³⁾

Input voltage (V _{IN})	1.2V to 5.5V
Supply voltage (V _{CC})	3V to 5.5V
Output voltage (V _{OUT})	1.2V to 5.5V
Operating junction temp (T _J)	-40°C to +125°C

Thermal Resistance ⁽⁴⁾	θ_{JA}	θ_{JC}
QFN-13 (2.5mmx3mm)	49	5.3...°C/W

Notes:

- 1) Exceeding these ratings may damage the device.
- 2) The maximum allowable power dissipation is a function of the maximum junction temperature, T_J (MAX), the junction-to-ambient thermal resistance, θ_{JA}, and the ambient temperature, T_A. The maximum allowable continuous power dissipation at any ambient temperature is calculated by P_D (MAX) = (T_J (MAX) - T_A) / θ_{JA}. Exceeding the maximum allowable power dissipation can cause excessive die temperature, and the device may go into thermal shutdown. Internal thermal shutdown circuitry protects the device from permanent damage.
- 3) The device is not guaranteed to function outside of its operating conditions.
- 4) Measured on a JESD51-7, 4-layer PCB.

ELECTRICAL CHARACTERISTICS

V_{IN} = 3.6V, V_{CC} = 3.6V, T_J = -40°C to +125°C, typical values are tested at T_J = 25°C, unless otherwise noted.

Parameters	Symbol	Condition	Min	Typ	Max	Units
Input and Supply Voltage Range						
Input voltage	V _{IN}		1.2		5.5	V
Supply voltage	V _{CC}		3		5.5	V
Supply Current						
Off state leakage current	I _{OFF}	V _{IN} = 5V, V _{EN} = 0V, T _J = 25°C		0.05	0.2	μA
		V _{IN} = 5V, V _{EN} = 0V, T _J = -40°C to +125°C			50	μA
V _{CC} standby current	I _{STBY}	V _{CC} = 5V, V _{EN} = 0V		0.01	1	μA
		V _{CC} = 5V, enabled, no load		220	330	μA
Power MOSFET						
On resistance	R _{DS(ON)}	V _{CC} = 5V		6.5	13	mΩ
		V _{CC} = 3.3V		8.5	16	mΩ
Thermal Shutdown and Recovery						
Shutdown temperature ⁽⁵⁾	T _{SD}			155		°C
Hysteresis ⁽⁵⁾	T _{HYS}			30		°C
Under-Voltage Lockout (UVLO) Protection						
V _{CC} UVLO rising threshold	V _{CC_UVLO}			2.5	2.8	V
V _{CC} UVLO hysteresis	V _{UVLO_HYS}			200		mV
Soft Start						
SS pull-up current	I _{SS}			9		μA
Enable (EN)						
EN rising threshold	V _{EN_RISING}		1.3	1.5	1.7	V
EN hysteresis	V _{EN_HYS}			400		mV
Current Limit (I_{LIMIT})						
Current limit	I _{LIMIT}	R _{LIM} = 50kΩ	1.36	1.7	2.04	A
		R _{LIM} = 26.1kΩ ⁽⁵⁾		3		A
I _{LIMIT} warning		R _{LIM} = 50kΩ	1.28	1.6	1.92	A
ILIM voltage	V _{ILIM}	R _{LIM} = 50kΩ		0.974		V
Sense ratio		R _{LIM} = 50kΩ		87000		
Discharge Resistance						
Discharge resistance	R _{DIS}			200		Ω
Power Good (PG)						
PG rising threshold	V _{PG_RISING}	Voltage gap between V _{OUT} & V _{IN}		150		mV
PG hysteresis	V _{PG_HYS}			50		mV
PG delay	t _{PG_DELAY}	Low to high		70		μs
PG high voltage	V _{PG_HIGH}	V _{CC} = 3.3V	3.2			V
PG low voltage	V _{PG_LOW}	Sink 1mA			0.2	V

Note:

5) Guaranteed by characterization. Not tested in production.

TYPICAL PERFORMANCE CHARACTERISTICS

$V_{IN} = 3.6V$, $V_{CC} = 3.6V$, $T_A = 25^\circ C$ unless otherwise noted.

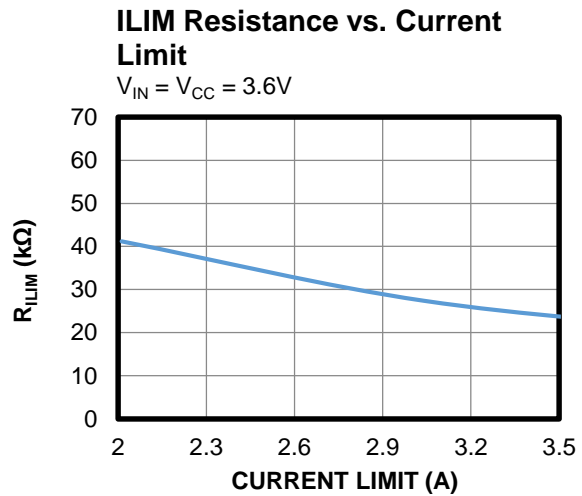
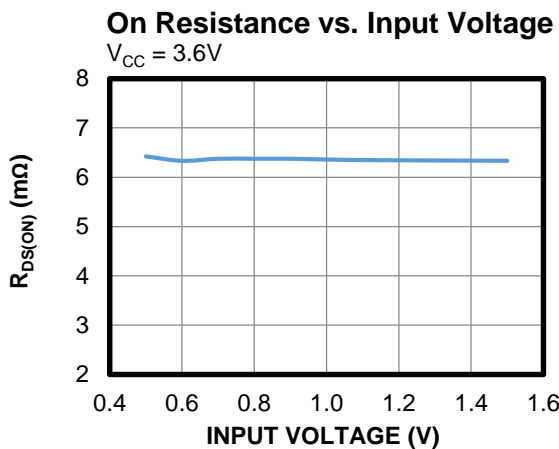
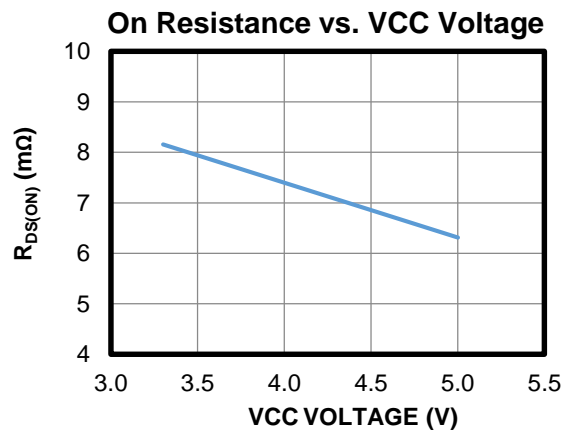
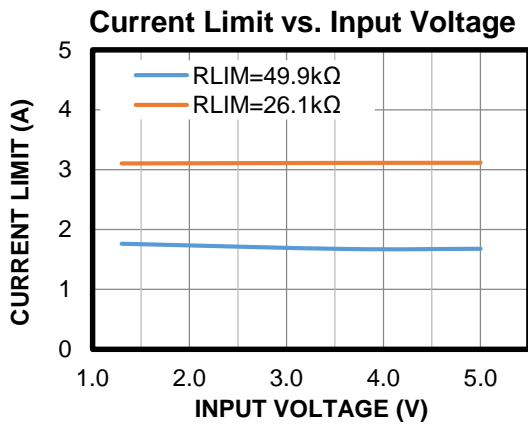
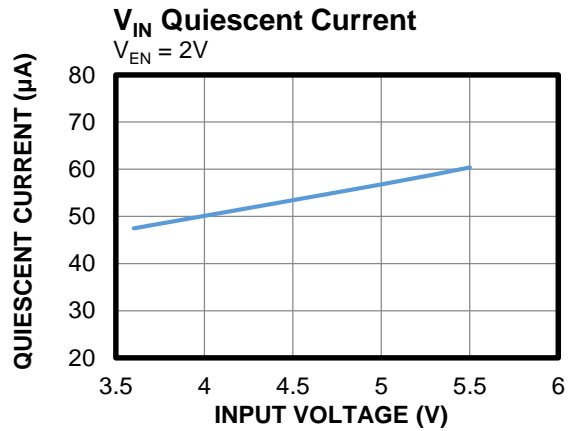
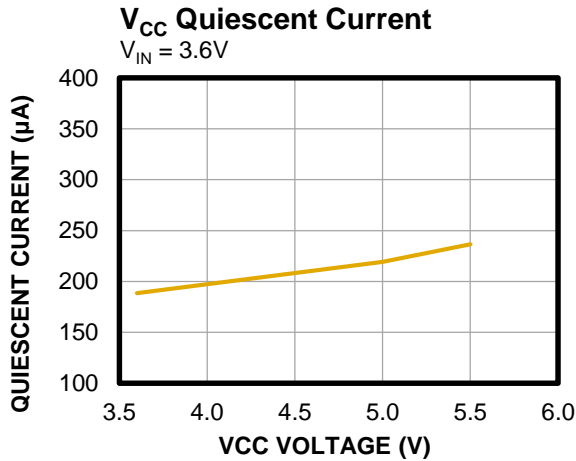

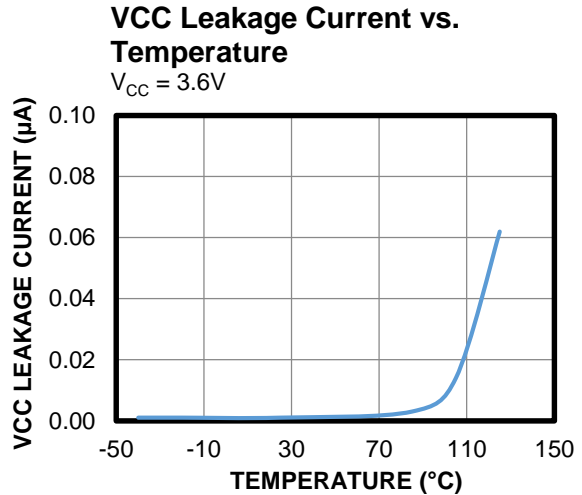
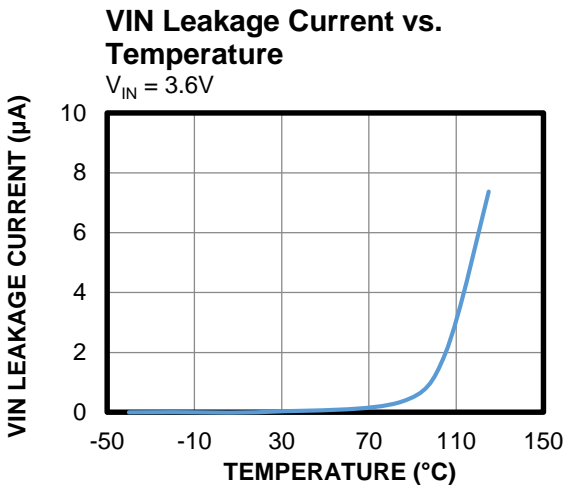
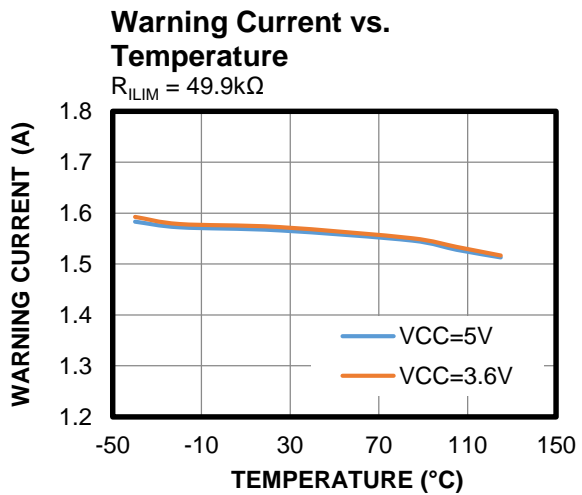
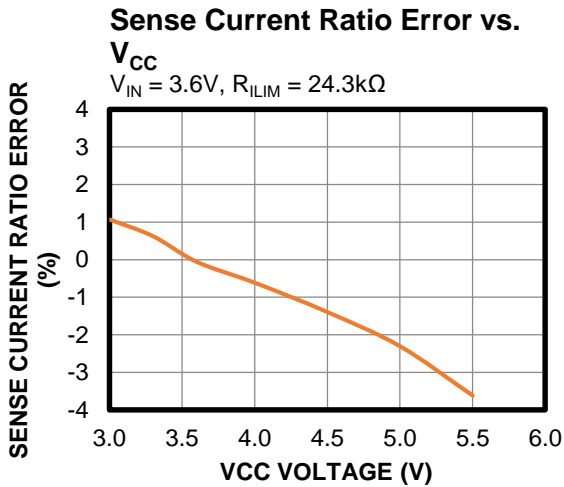
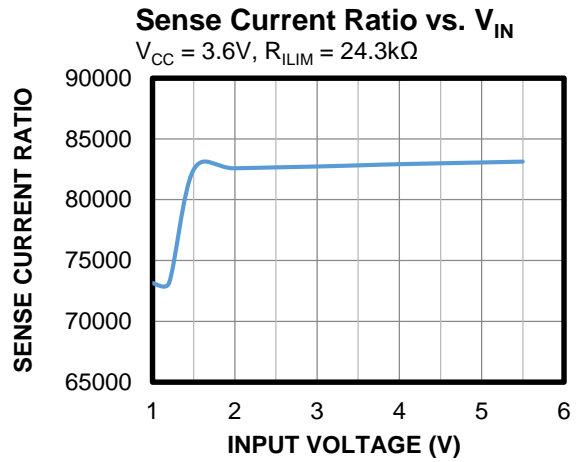
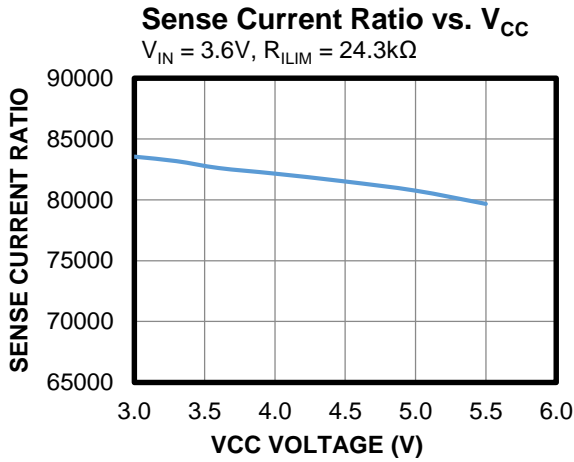
TYPICAL PERFORMANCE CHARACTERISTICS (continued)
 $V_{IN} = 3.6V$, $V_{CC} = 3.6V$, $T_A = 25^\circ C$ unless otherwise noted.

TYPICAL PERFORMANCE CHARACTERISTICS (continued)

$V_{IN} = 3.6V$, $V_{CC} = 3.6V$, $T_A = 25^\circ C$ unless otherwise noted.

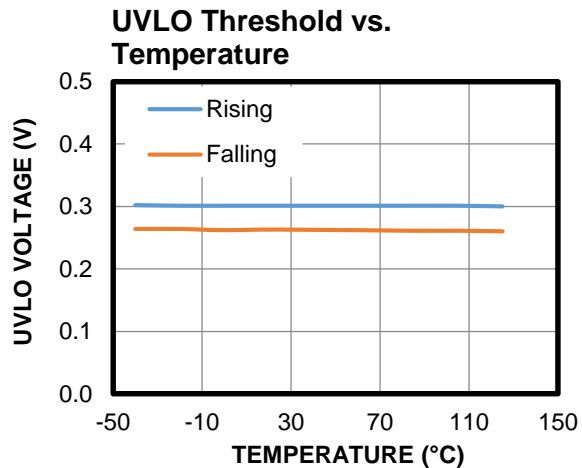
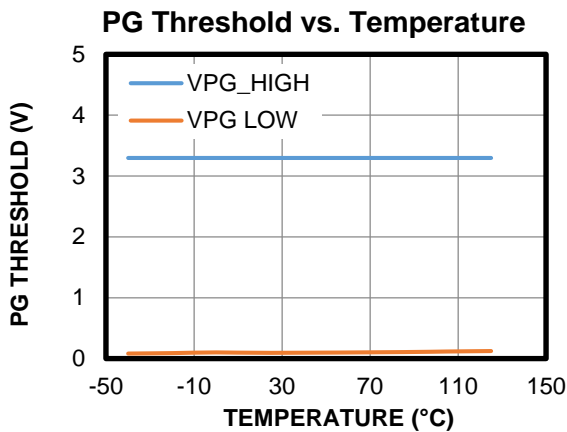
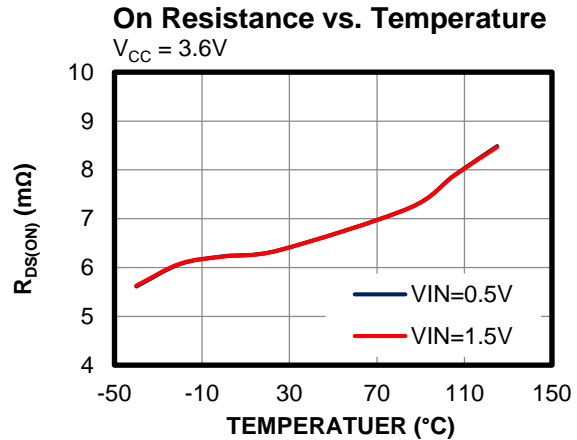
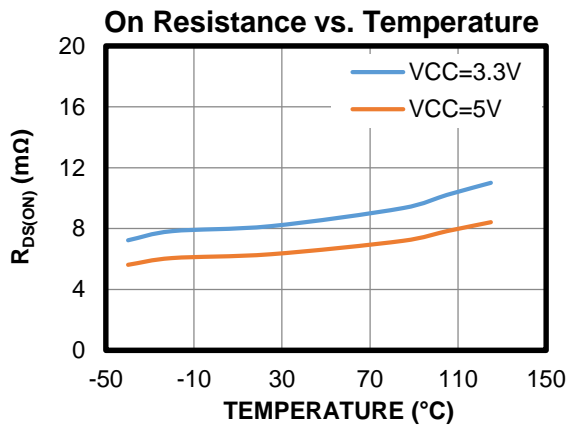
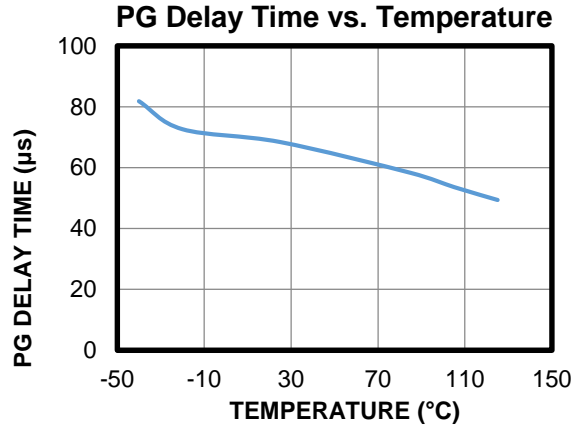
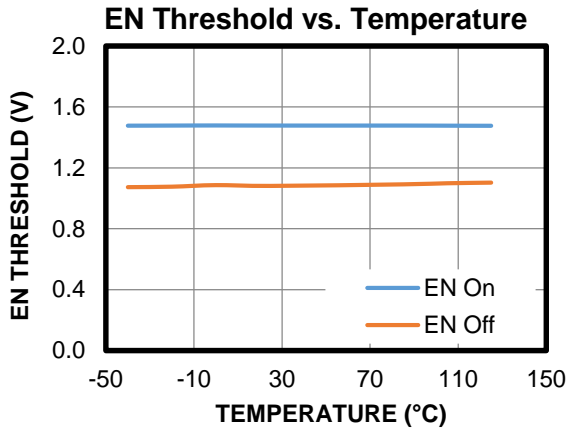

TYPICAL PERFORMANCE CHARACTERISTICS *(continued)*

$V_{IN} = 3.6V$, $V_{CC} = 3.6V$, $T_A = 25^\circ C$ unless otherwise noted.

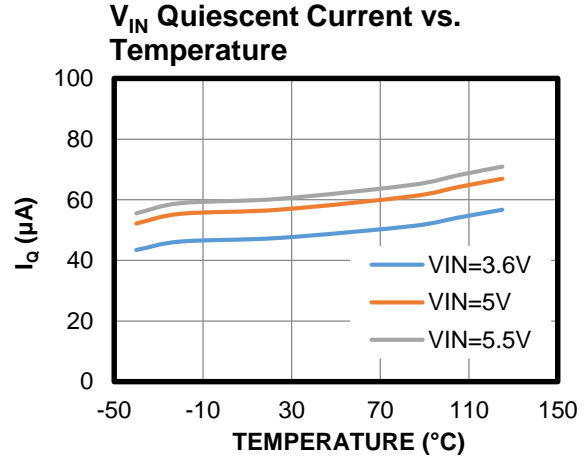
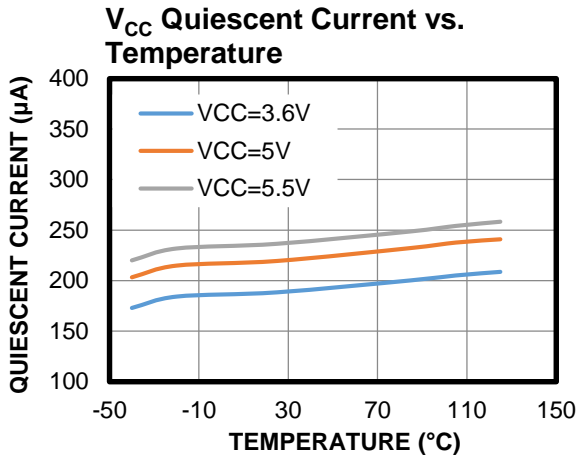

TYPICAL PERFORMANCE CHARACTERISTICS (continued)
 $V_{IN} = 3.6V$, $V_{EN} = 3.6V$, $R_{LIM} = 26.1k\Omega$, $T_A = 25^\circ C$, unless otherwise noted.

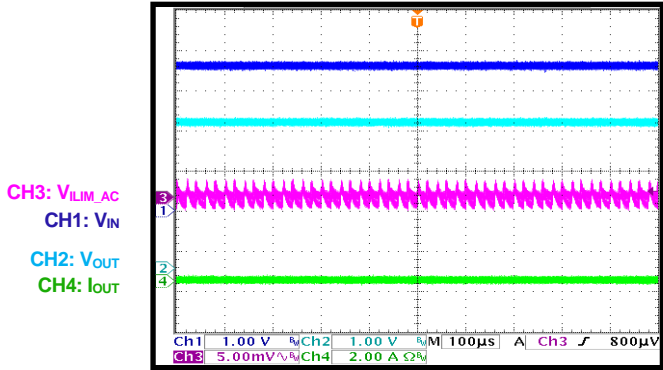
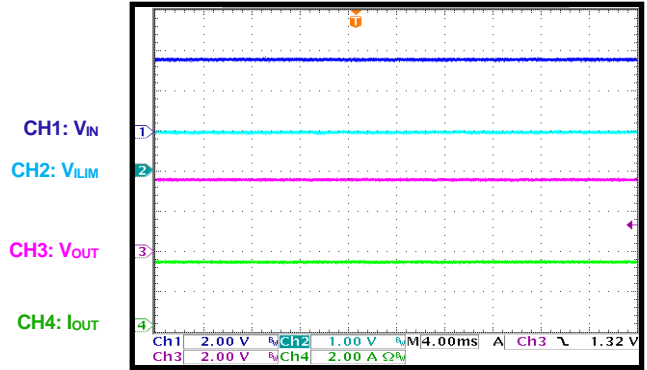
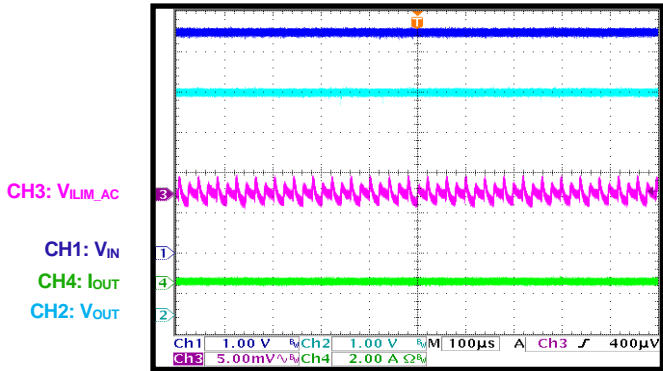
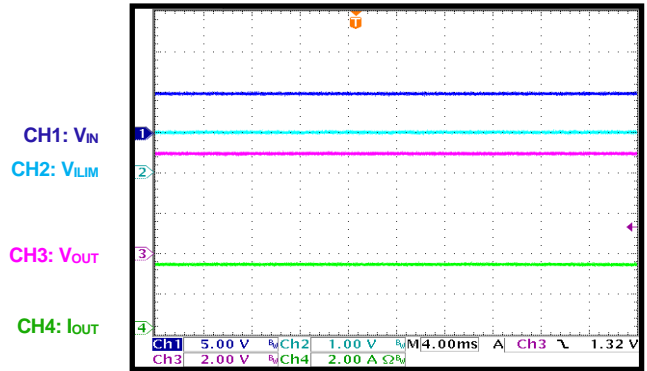
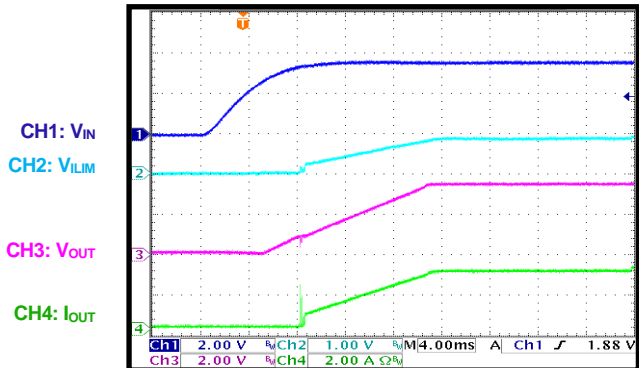
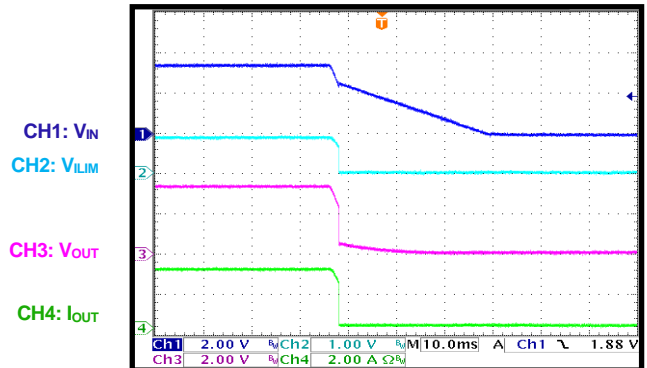
Steady State
 $V_{IN} = V_{CC} = 3.6V$, $I_{OUT} = 0A$

Steady State
 $V_{IN} = V_{CC} = 3.6V$, $I_{OUT} = 3A$

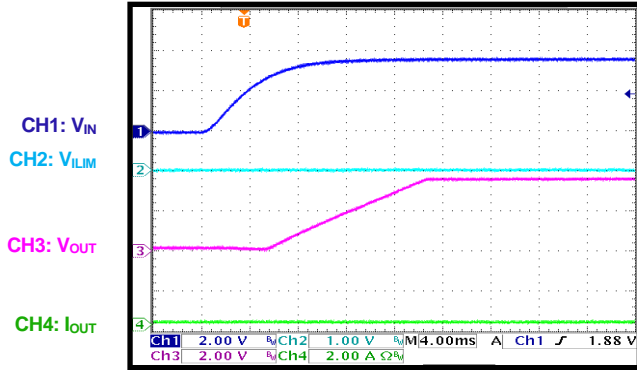
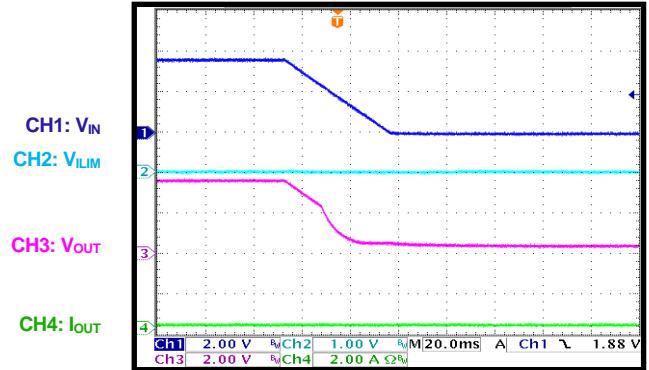
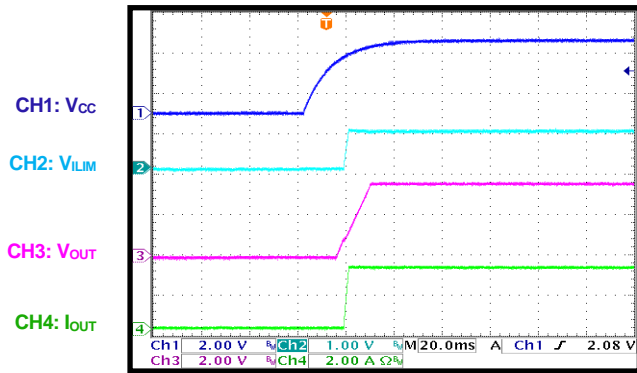
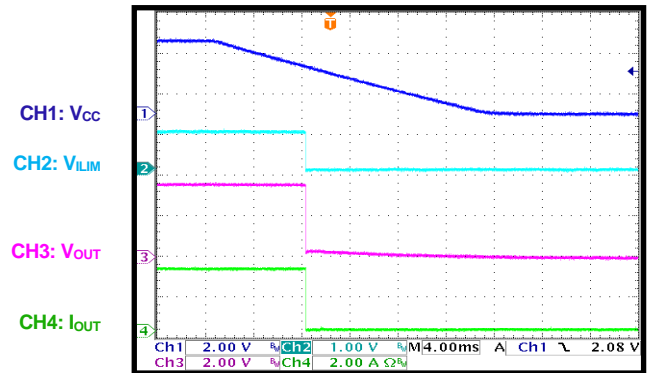
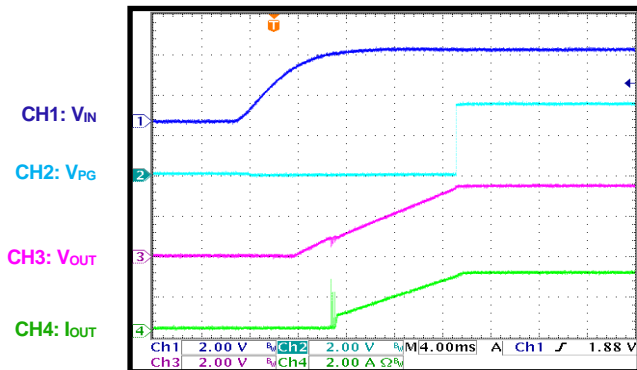
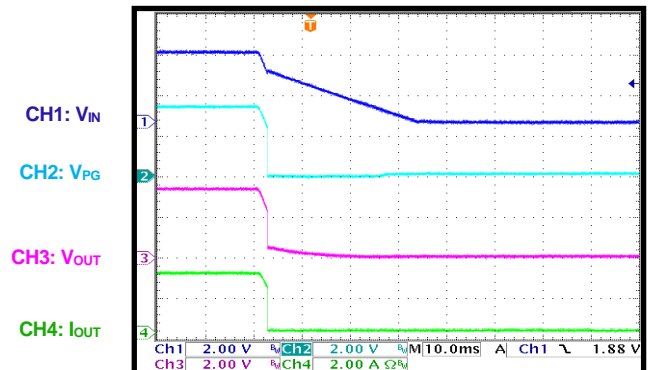
Steady State
 $V_{IN} = 5.5V$, $V_{CC} = 3.6V$, $I_{OUT} = 0A$

Steady State
 $V_{IN} = 5V$, $V_{CC} = 5V$, $I_{OUT} = 3A$

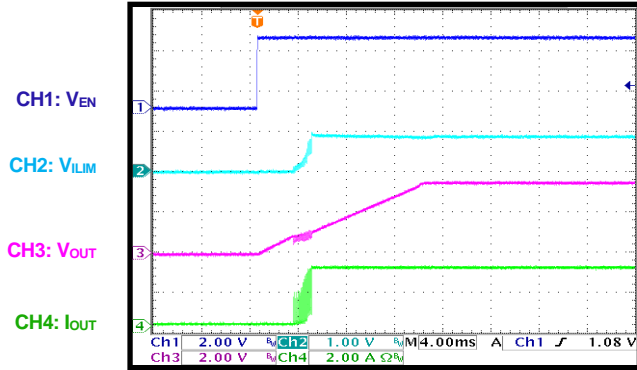
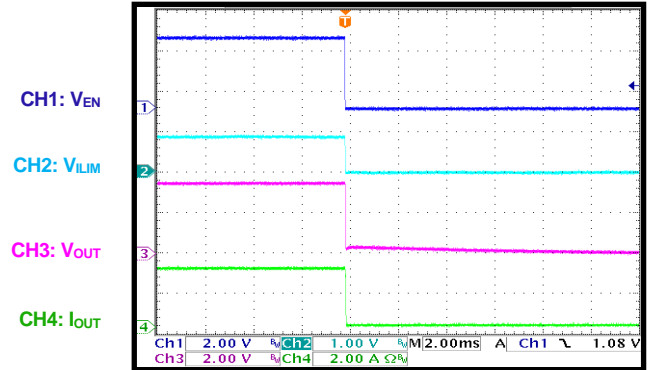
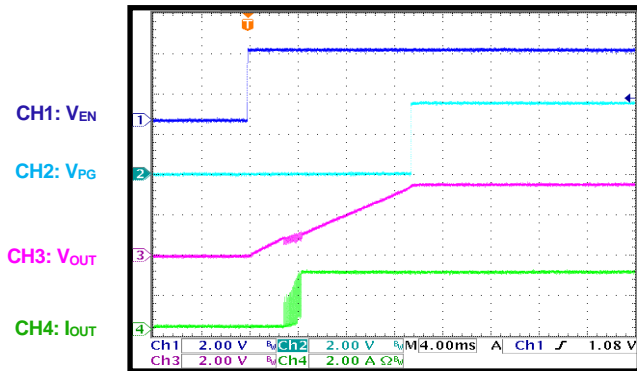
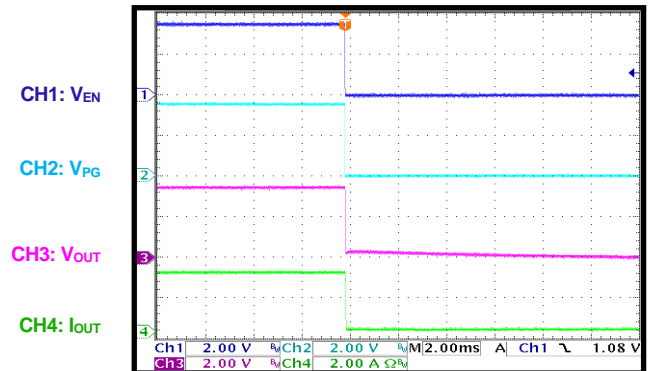
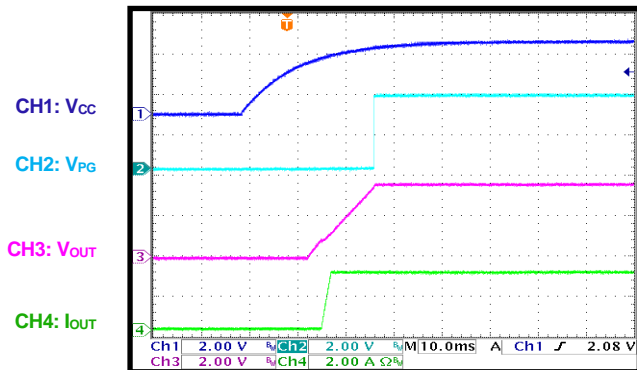
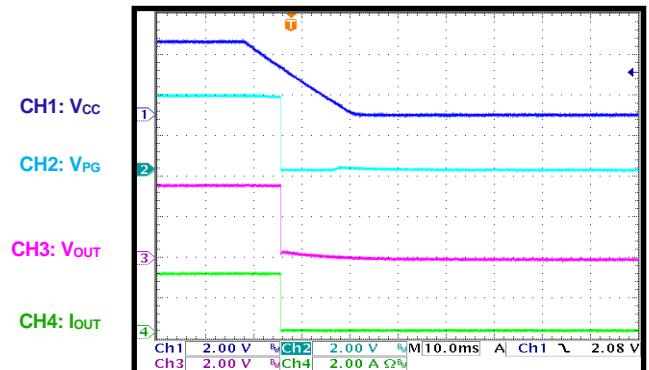
Start-Up
 $V_{IN} = V_{CC} = 3.6V$, $I_{OUT} = 3A$

Shutdown
 $V_{IN} = V_{CC} = 3.6V$, $I_{OUT} = 3A$

TYPICAL PERFORMANCE CHARACTERISTICS (continued)
 $V_{IN} = 3.6V$, $V_{EN} = 3.6V$, $R_{ILIM} = 26.1k\Omega$, $T_A = 25^\circ C$, unless otherwise noted.

Start-Up
 $V_{IN} = V_{CC} = 3.6V$, $I_{OUT} = 0A$

Shutdown
 $V_{IN} = V_{CC} = 3.6V$, $I_{OUT} = 0A$

VCC On
 $V_{IN} = V_{EN} = 3.6V$, $V_{CC} = 3.6V$, $I_{OUT} = 3A$

VCC Off
 $V_{IN} = V_{EN} = 3.6V$, $V_{CC} = 3.6V$, $I_{OUT} = 3A$

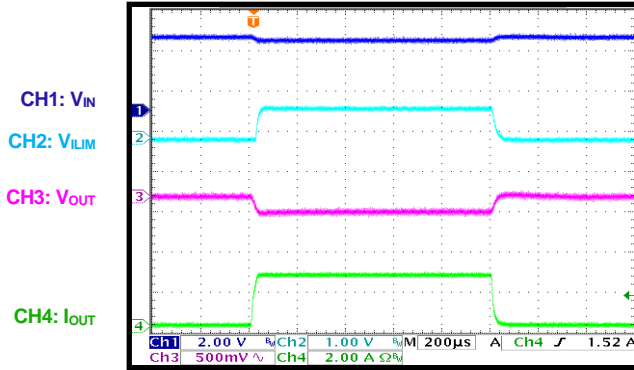
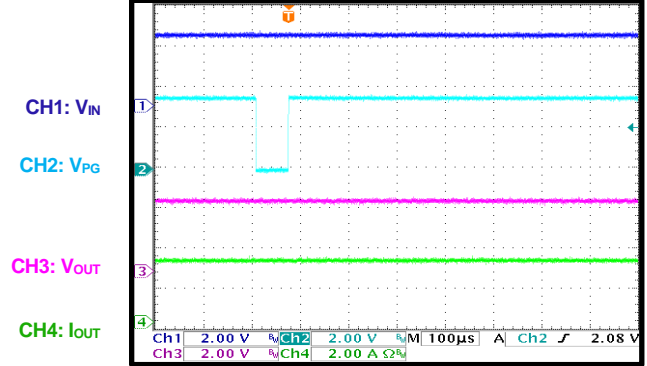
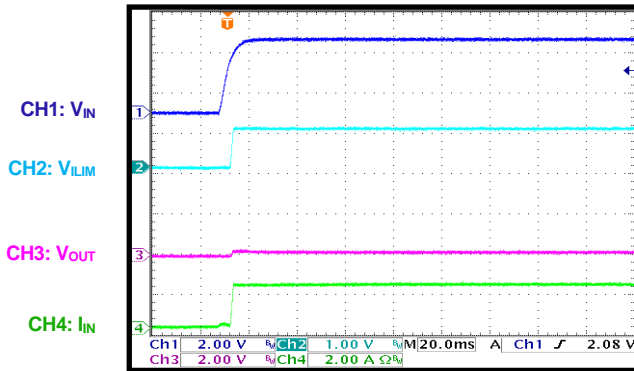
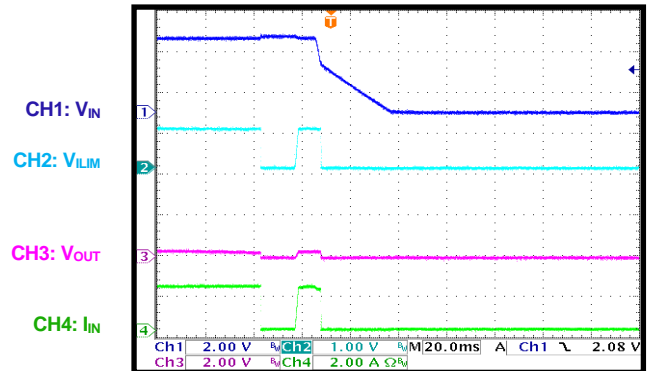
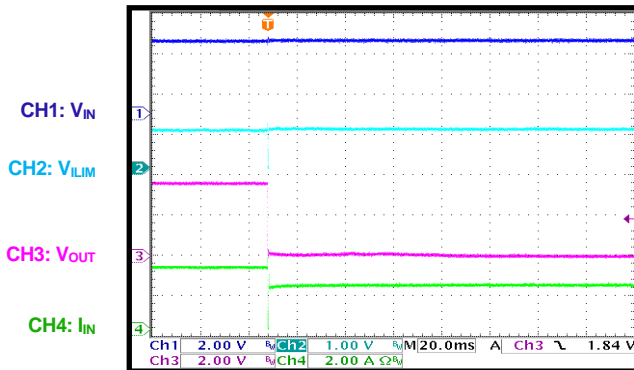
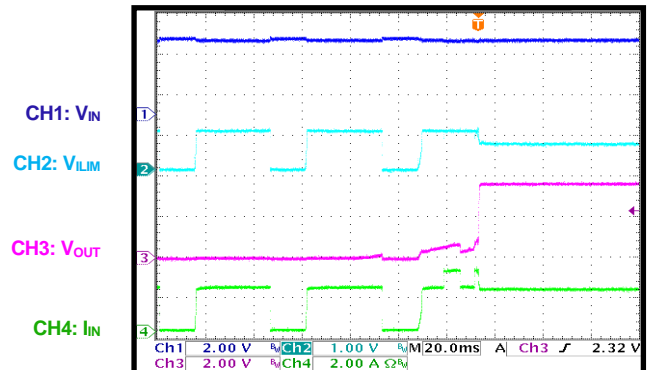
Start-Up with PG
 $V_{IN} = V_{CC} = 3.6V$, $I_{OUT} = 2.9A$

Shutdown with PG
 $V_{IN} = V_{CC} = 3.6V$, $I_{OUT} = 2.9A$

TYPICAL PERFORMANCE CHARACTERISTICS (continued)
 $V_{IN} = 3.6V$, $V_{EN} = 3.6V$, $R_{LIM} = 26.1k\Omega$, $T_A = 25^\circ C$, unless otherwise noted.

EN Start-Up
 $V_{IN} = V_{CC} = 3.6V$, $I_{OUT} = 2.9A$

EN Shutdown
 $V_{IN} = V_{CC} = 3.6V$, $I_{OUT} = 2.9A$

EN Start-Up with PG
 $V_{IN} = V_{CC} = 3.6V$, $I_{OUT} = 2.9A$

EN Shutdown with PG
 $V_{IN} = V_{CC} = 3.6V$, $I_{OUT} = 2.9A$

VCC Start-Up with PG
 $V_{IN} = V_{EN} = 3.6V$, $I_{OUT} = 2.9A$

VCC Shutdown with PG
 $V_{IN} = V_{EN} = 3.6V$, $I_{OUT} = 2.9A$

TYPICAL PERFORMANCE CHARACTERISTICS (continued)
 $V_{IN} = 3.6V$, $V_{EN} = 3.6V$, $R_{ILIM} = 26.1k\Omega$, $T_A = 25^\circ C$, unless otherwise noted.

Load Transient
 $V_{IN} = V_{CC} = 3.6V$, $I_{OUT} = 0A$ to $2.5A$

Current Limit Warning
 $V_{IN} = V_{CC} = 3.6V$, $I_{OUT} = 2.97A$

SCP Start-Up
 $V_{IN} = V_{CC} = V_{EN} = 3.6V$

SCP Shutdown
 $V_{IN} = V_{CC} = V_{EN} = 3.6V$

SCP
 $V_{IN} = V_{CC} = 3.6V$, $I_{OUT} = 3A$

SCP Recovery
 $V_{IN} = V_{CC} = 3.6V$, $I_{OUT} = 2A$

FUNCTIONAL BLOCK DIAGRAM

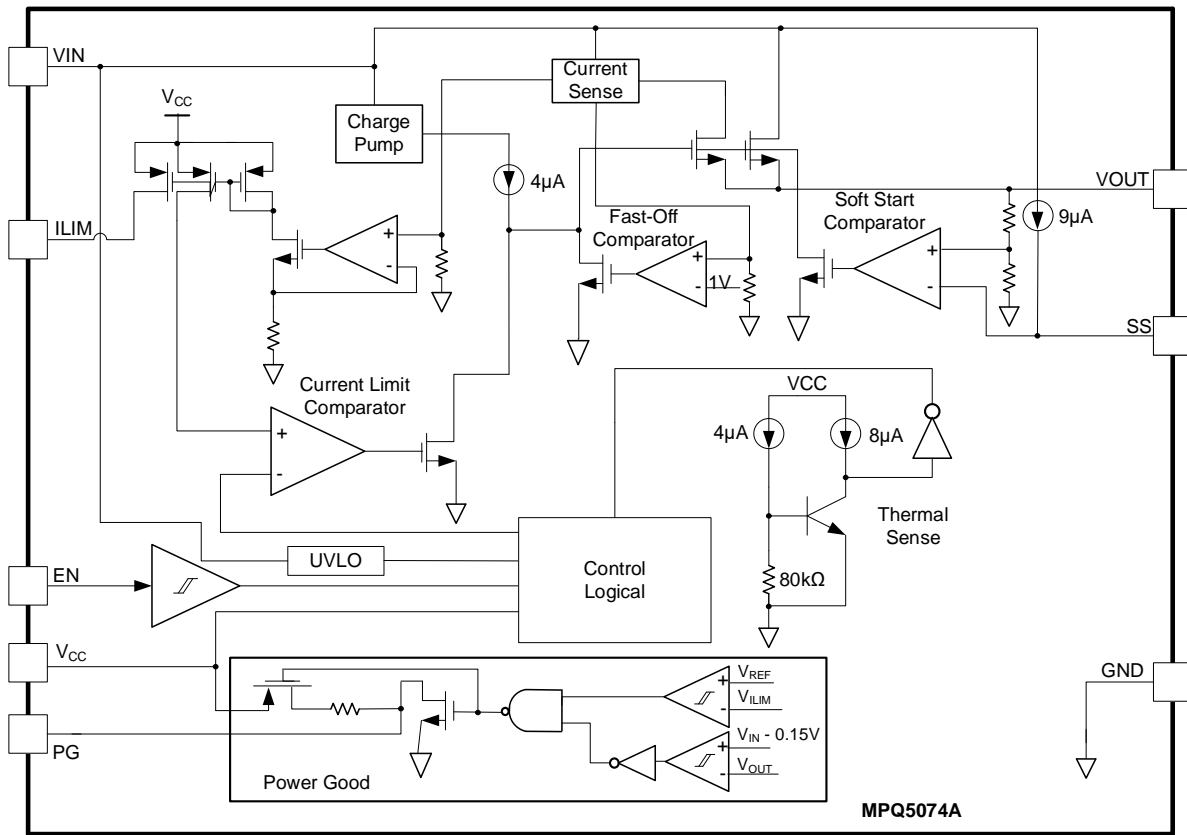

Figure 1: Functional Block Diagram

OPERATION

The MPQ5074 is designed to limit the inrush current to the load, limiting the backplane voltage drop and the slew rate. The device provides an integrated solution that monitors the input voltage (V_{IN}), output voltage (V_{OUT}), and output current (I_{OUT}) to eliminate the need for an external current power MOSFET and current-switch device.

Enable (EN)

If V_{IN} exceeds the under-voltage lockout (UVLO) threshold (typically 0.5V), then the MPQ5074 can be turned on by pulling the EN pin above 1.5V. Pull EN to ground to turn it off.

Current Limit

The MPQ5074 provides a constant current limit (I_{LIMIT}) that can be configured via an external resistor (R_{ILIM}). Once the device reaches its I_{LIMIT} threshold, the internal circuit regulates the gate voltage (V_{GATE}) to main the constant power MOSFET current. The typical response time is about 20 μ s. I_{OUT} may have a small overshoot during this response time.

The preset I_{LIMIT} can be calculated with Equation (1):

$$I_{LIMIT} = (0.974 \div R_{ILIM}) \times S \quad (1)$$

Where 0.974 is the reference value, and S is the MPQ5074's current-sense ratio (typically 87000 at $V_{IN} = 3.6V$).

If V_{CC} and V_{IN} are changed, then the current-sense ratio changes slightly. For more information, see the Typical Performance Characteristics section on page 5.

If the I_{LIMIT} block starts to regulate I_{OUT} , the power MOSFET's power loss causes the IC's temperature to rise. If the junction temperature (T_J) exceeds 155°C, thermal shutdown is triggered. Once the part shuts down due to thermal shutdown, the output is disabled until the over-temperature (OT) fault is removed. Thermal shutdown has a hysteresis of 30°C.

Power Good (PG)

The PG pin is the push-pull output of a MOSFET that can be pulled up to V_{CC} . The MOSFET turns on once V_{IN} is present, and then the PG pin is

pulled to GND. Once the voltage gap between V_{IN} and V_{OUT} drops below 150mV, the PG pin is pulled high after a 70 μ s delay. If the voltage gap exceeds 200mV or an over-current (OC) limit warning occurs, the PG pin is pulled low without a delay. The PG pin has a normal 200 Ω pull-down resistance and a 250k Ω pull-up resistance. The maximum sink current capability should be below 10mA.

Short-Circuit Protection (SCP)

If the load current (I_{LOAD}) increases rapidly due to a short circuit, then the current may significantly exceed the I_{LIMIT} threshold before the control loop can respond. If the current reaches the secondary internal I_{LIMIT} level (typically 3A), a fast turn-off circuit turns off the power MOSFET to limit the peak current flowing through the switch. This limits the V_{IN} drop. The total short-circuit response time is about 200ns. If fast turn-off is effective, the power MOSFET turns off for 80 μ s, and then turns on again. If the short circuit is still present after the fast turn-off sequence, the MPQ5074 reduces the current limit to 2/3 of the preset value and hold it there until thermal shutdown is triggered. Once the short circuit is removed, I_{LIMIT} recovers to the preset value automatically.

Output Discharge

The MPQ5074 has an output discharge function. If the part is shut down through EN or VCC during light-load operation, the output is discharged via an internal pull-down resistor.

Soft Start (SS)

The soft-start capacitor (C_{SS}) determines the soft-start time (t_{SS}). An internal constant current (I_{SS}) (9 μ A) charges C_{SS} and ramps up the SS pin voltage (V_{SS}). V_{OUT} rises at three times the slew rate of V_{SS} .

t_{SS} can be calculated with Equation (2):

$$t_{SS}(\text{ms}) = \frac{1}{3} \times \frac{V_{OUT}(\text{V}) \times C_{SS}(\text{nF})}{I_{SS}(\mu\text{A})} \quad (2)$$

It is recommended that C_{SS} be >4.7nF. If the SS pin is floating or C_{SS} is <4.7nF, the V_{OUT} rise time is limited by the power MOSFET's charge time.

APPLICATION INFORMATION

Selecting the ILIM Resistor (R_{ILIM})

The I_{LIMIT} value can be set by $ILIM$ resistor (R_{ILIM}). I_{LIMIT} can be calculated with Equation 1 on page 14.

It is recommended that the I_{LIMIT} threshold be 10% to 20% greater than the maximum I_{LOAD} (I_{LOAD_MAX}). For example, if the system's full load is 3A, then I_{LIMIT} should be set at 3.3A.

Selecting the Soft-Start Capacitor (C_{SS})

I_{SS} ($9\mu A$) charges C_{SS} and ramps up V_{SS} . V_{OUT} rises at three times the slew rate of V_{SS} .

If the output inrush current reaches I_{LIMIT} during start-up (e.g. due to a large output capacitance or very large load), the MPQ5074 limits V_{OUT} , and t_{SS} lengthens (see Figure 2 and Figure 3).

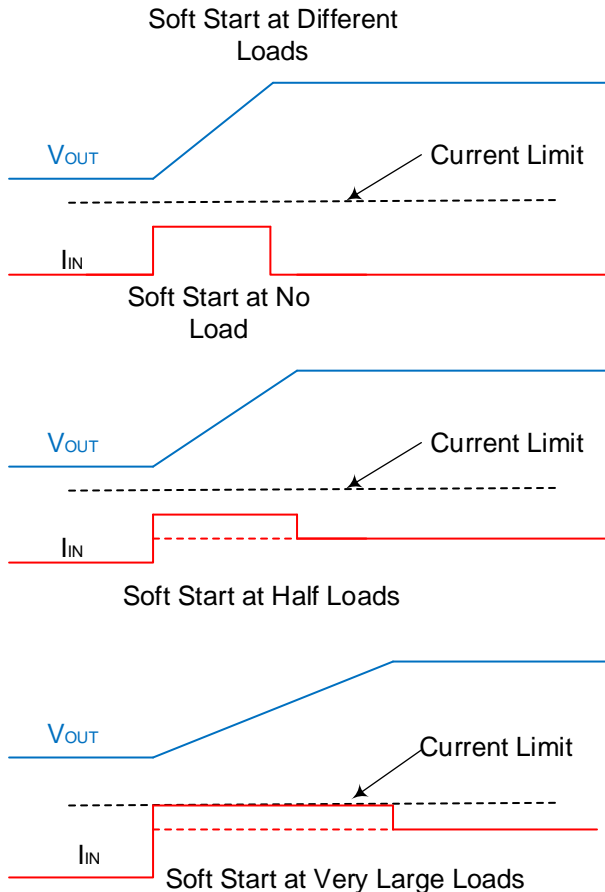

Figure 2: Soft-Start Time at Different Loads

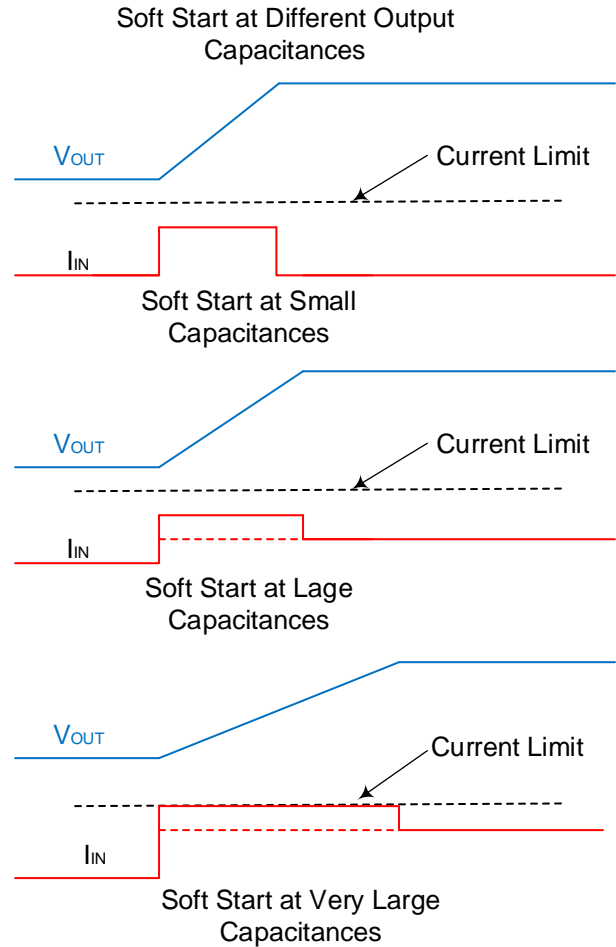

Figure 3: Soft-Start Time at Different Output Capacitances

Design Example

Table 1 shows a design example following the application guidelines for the specifications below, and are provided below (see Table 1). See Figure 4 for more details.

Table 1: Design Example

V_{IN} (V)	Max Load Range (A)	R_{ILIM} (k Ω)	C_{SS} (nF)	t_{SS} (ms)
5	3	26.1	22	4
5	5	15.8	47	9

Figure 5 on page 17 shows a typical application circuit.

PCB Layout Guidelines

Efficient PCB layout is critical for stable operation. For the best results, refer to Figure 4 and follow the guidelines below:

1. Place R_{ILIM} close to the ILIM pin.
2. Place the input capacitor close to the VCC pin.
3. Place multiple vias near the IC to improve thermal performance.

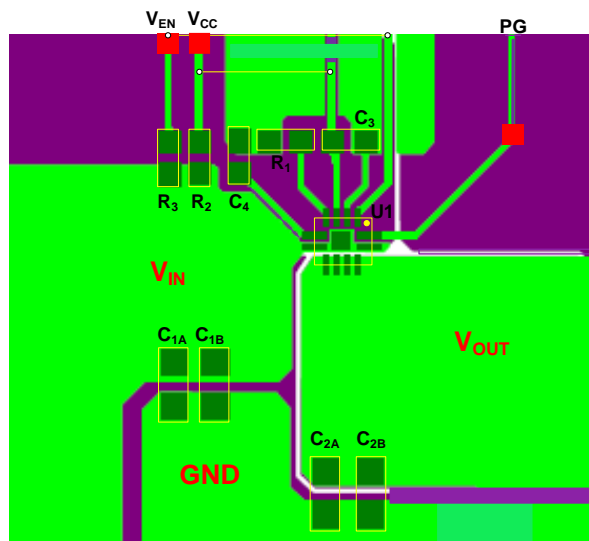

Figure 4: Recommended PCB Layout

TYPICAL APPLICATION CIRCUIT

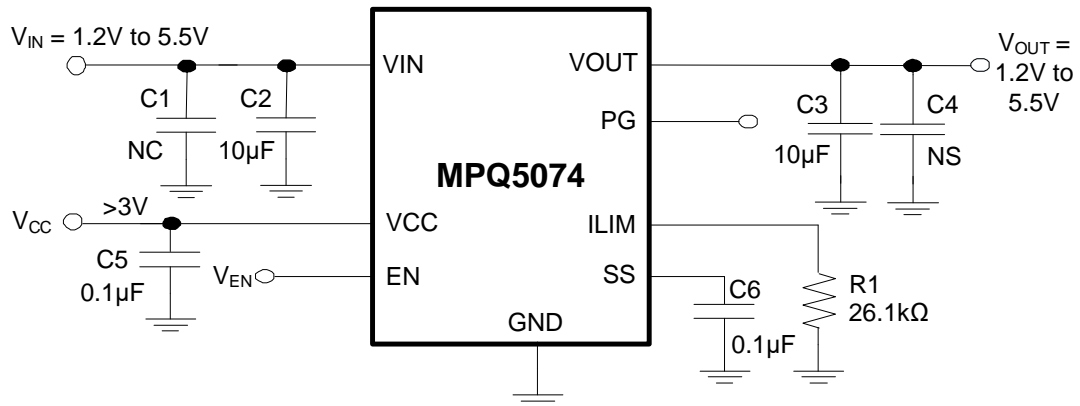
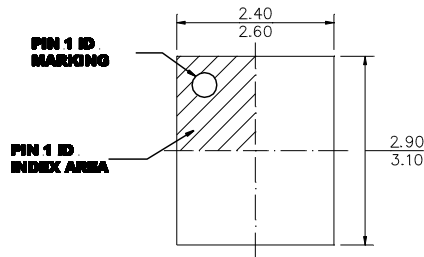

Figure 5: Typical Application Circuit

PACKAGE INFORMATION

QFN-13 (2.5mmx3mm)



TOP VIEW

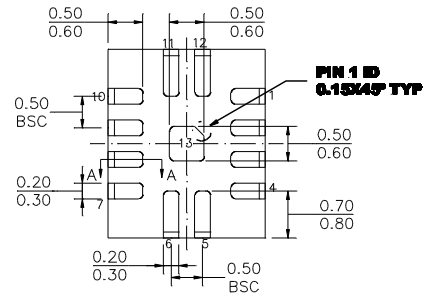

BOTTOM VIEW

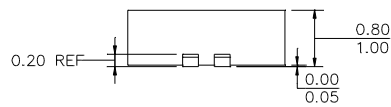

SIDE VIEW

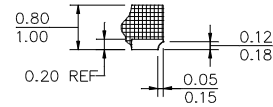

SECTION A-A

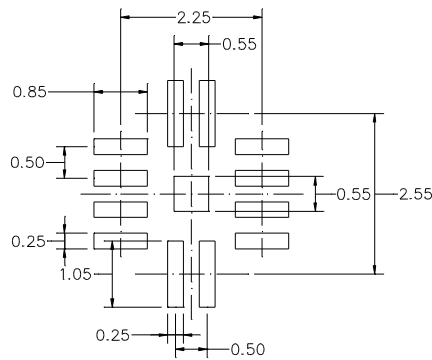

RECOMMENDED LAND PATTERN

NOTE:

- 1) THE LEAD SIDE IS WETTABLE.
- 2) ALL DIMENSIONS ARE IN MILLIMETERS.
- 3) LEAD COPLANARITY SHALL BE 0.08 MILLIMETERS MAX.
- 4) JEDEC REFERENCE IS MO-220.
- 5) DRAWING IS NOT TO SCALE.

CARRIER INFORMATION

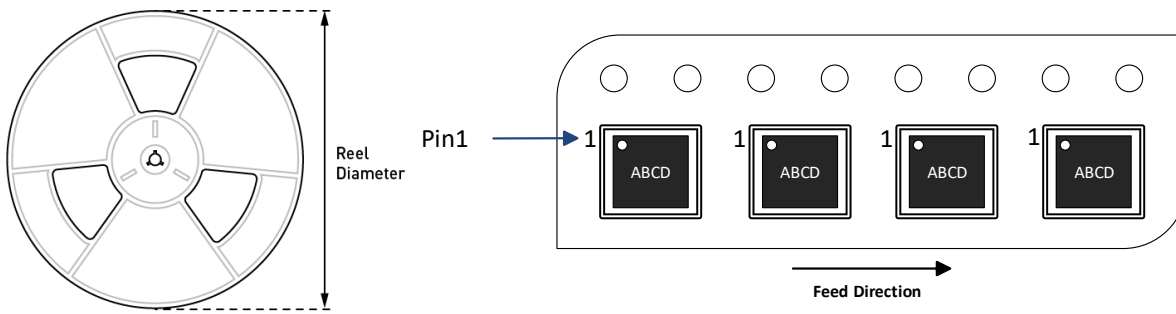

Part Number	Package Description	Quantity/ Reel	Quantity/ Tube	Quantity/ Tray	Reel Diameter	Carrier Tape Width	Carrier Tape Pitch
MPQ5074GQBE-AEC1-Z	QFN-13 (2.5mmx3mm)	5000	N/A	N/A	13in	12mm	8mm



REVISION HISTORY

Revision #	Revision Date	Description	Pages Updated
1.0	8/21/2023	Initial Release	-

Notice: The information in this document is subject to change without notice. Please contact MPS for current specifications. Users should warrant and guarantee that third-party Intellectual Property rights are not infringed upon when integrating MPS products into any application. MPS will not assume any legal responsibility for any said applications.