

MPS Management

November 9th, 2023

MPS

Forward Looking Statements

This presentation includes forward-looking statements that involve risks and uncertainties, including our belief in continued expansion of our product lines, advances in our technology, anticipated market opportunities, gross margin targets, net & operating margin targets, inventory targets, continuing business diversification, growth and opportunities in China and Taiwan, and increasing sales penetration in Japan, Korea, the U.S., Singapore and Europe. Other forward-looking statements can be identified by terms such as “would,” “could,” “may,” “will,” “should,” “expect,” “Wall Street estimates,” “intend,” “plan,” “anticipate,” “believe,” “estimate,” “predict,” “potential,” “targets,” “target ranges”, “seek,” or “continue,” the negative of these terms or other variations of such terms. These statements are only predictions based on our current expectations and projections about future events. Because these forward-looking statements involve risks and uncertainties, there are important factors that could cause our actual results, level of activity, performance or achievements to differ materially from the results, level of activity, performance or achievements expressed or implied by the forward-looking statements. In this regard, you should specifically consider the risks identified in our most recent 10-K in the section entitled “Risk Factors,” including the risks, uncertainties and cost of litigation and risks related to fluctuations in our operating results.

MPS Growing, Even in Tough Markets (\$M)

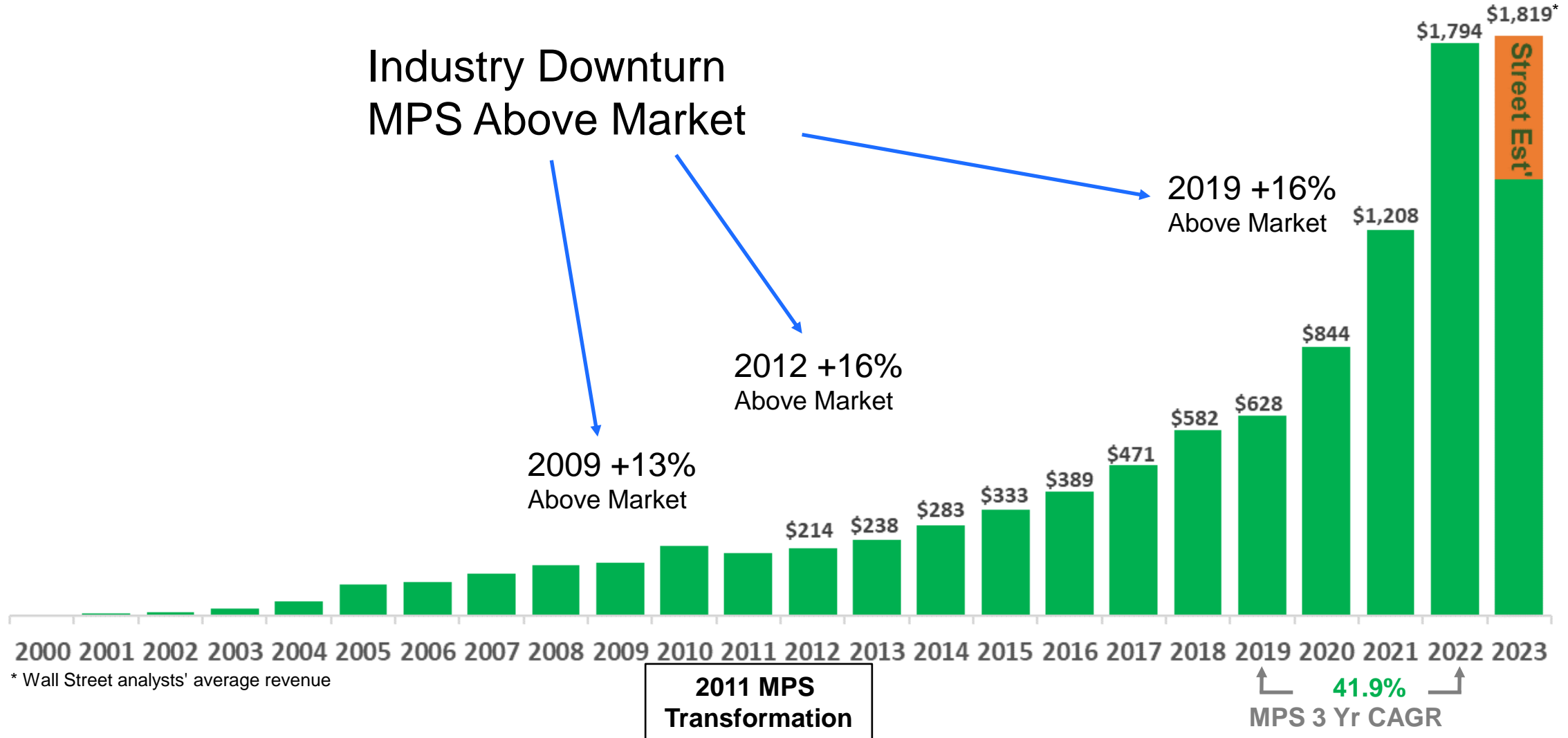

Great Revenue Diversification by GEO & End Customer

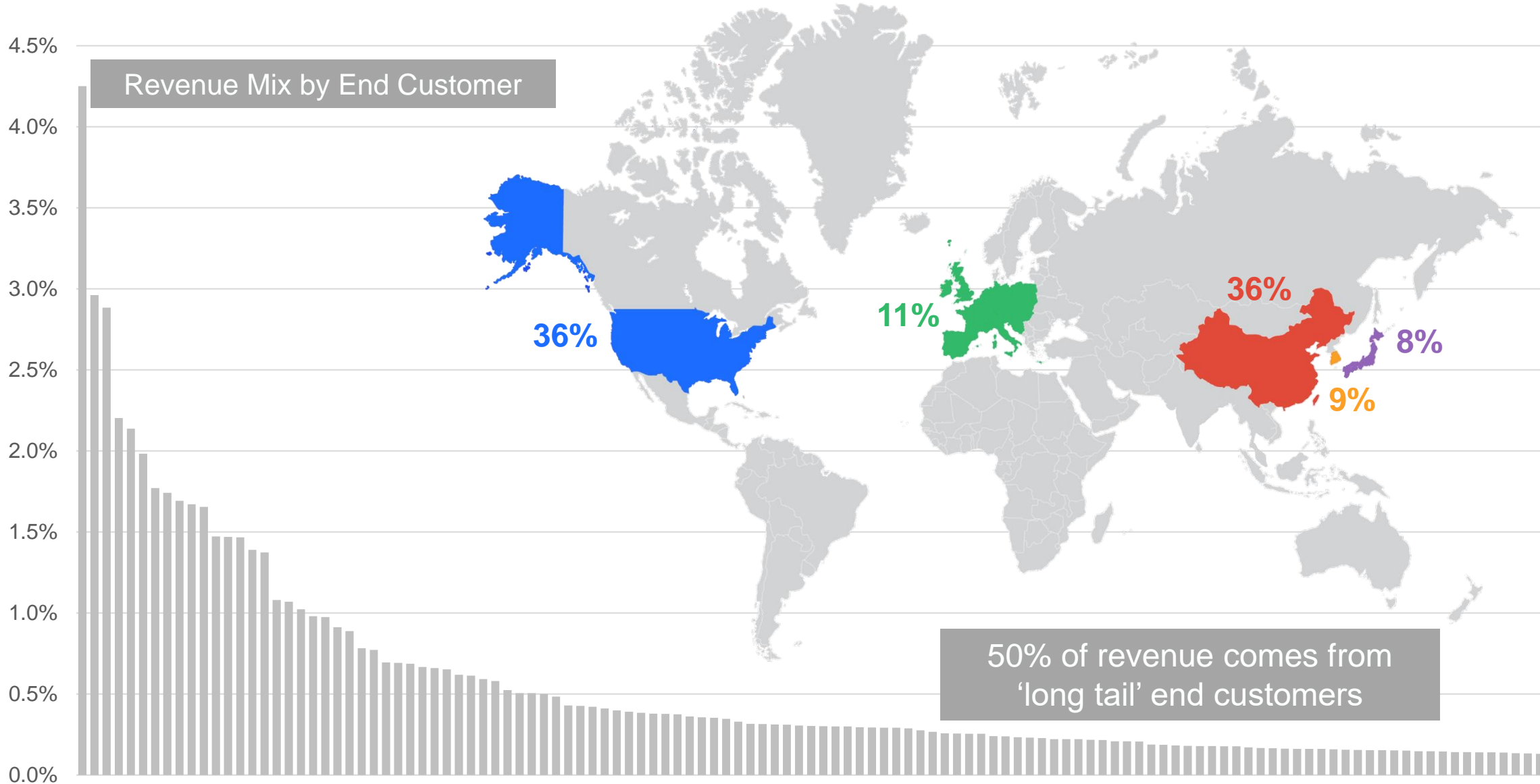

Growth Drivers by End Market

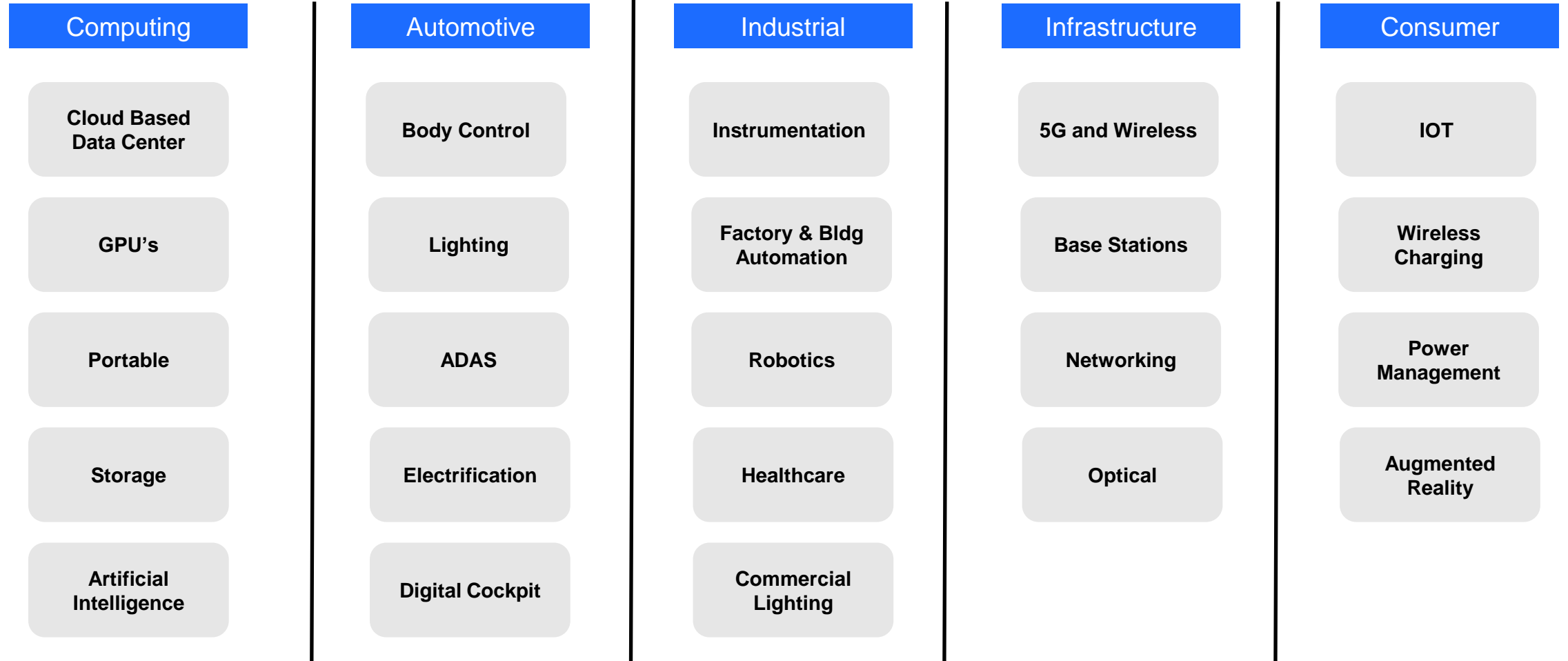

Leveraging 4000+ Products

AC/DC Power Conversion

- High-Voltage Buck Regulators
- High-Voltage LDOs
- Flyback Controllers
- Flyback Synchronous Rectifiers
- Active PFC Controllers
- LLC Resonant Converter Controllers
- LLC Synchronous Rectifiers
- PFC & LLC Combo Controllers
- X Capacitor Bleeders

Display Backlighting Power

- Backlight Drivers
- Electroluminescent Drivers
- Photo Flash Drivers
- LCD Power Supplies

Computing Power

- CPU Core Power
- High-Current DrMOS
 - 60A DrMOS in a QFN (4mmx5mm) Package
- POL

DC/DC Power Conversion

- Step-Up (Boost)
- Step-Down (Buck)
- Buck/Boost
- CPU Core Power
 - 50A DrMOS in a QFN (5mmx5mm) Package
- Power Magnetics
 - Molded Inductors
 - Semi-Shielded Inductors

E-Fuse, USB & Load Switches

- Programmable Current Limit Up to 50A per Device
- Adjustable Slew Rate
- Reverse Current Blocking
- Output Discharge (Load Switch)
- Integrated Auto-Detection
- Pin Compatible
- Parallelable Up to 10 Devices
- PMBus Command and Control

Motor Drivers & Position Sensors

- Brushless DC Motor Drivers
- Stepper Motor Drivers
- Brushed DC Motor/Solenoid Drivers
- Half-Bridge/Full-Bridge/Three-Phase Power Stages
- Magnetic Angular Position Sensors

Isolated Solutions

- Isolated Gate Drivers
- Isolated Power Module
- Digital Isolator with Integrated Power
- Digital Isolators
- Totem-Pole PFC/LLC Controller

Automotive & Industrial

- AEC-Q100
 - DC/DC
 - LED Lighting
 - Power Modules
 - Motor Drivers
 - USB Charging
 - Display Backlighting
 - Precision Analog

Power Modules

- 6V, 600mA to 4A
- 16V, 600mA to 60A
- 21V, 600mA to 2A
- 36V, 600mA to 5A
- 55V, 1A to 3A
- 75V, 300mA

Battery Management

- Li-Ion Single and Multi-Cell
- USB-Complaint Chargers
- Switching Chargers
- Linear Chargers
- Integrated Power Bank Solutions

LED Lighting & Illumination

- TRIAC Dimmable AC/DC LED Controllers
- PWM and Analog Dimmable AC/DC LED Controllers
- DC/DC LED Controllers: Buck, Boost, & Buck-Boost
- LED Protection ICs

Class-D Audio, Precision Analog

- Analog Input Class-D Amplifiers
- PWM Input Power Stages
- Analog Switches
- Current-Sense Amplifiers
- Operational Amplifiers
- Voltage Reference

Diverse End Markets

% of Revenue	2010	2020	2022	23Q3	2019-2022 CAGR
Enterprise Data	-	8.6%	14.0%	20.8%	73.7%
Storage and Computing	10.4%	21.4%	25.3%	27.3%	47.4%
Consumer	65.1%	26.1%	17.8%	13.1%	24.8%
Communications	17.8%	16.9%	14.0%	9.9%	43.7%
Automotive	1.9%	12.9%	16.7%	20.0%	49.2%
Industrial / Other	4.8%	14.2%	12.2%	8.9%	30.2%
Total	100%	100%	100%	100%	41.9%

MPS Technology Evolution

Proprietary Technologies Drive SAM Proliferation

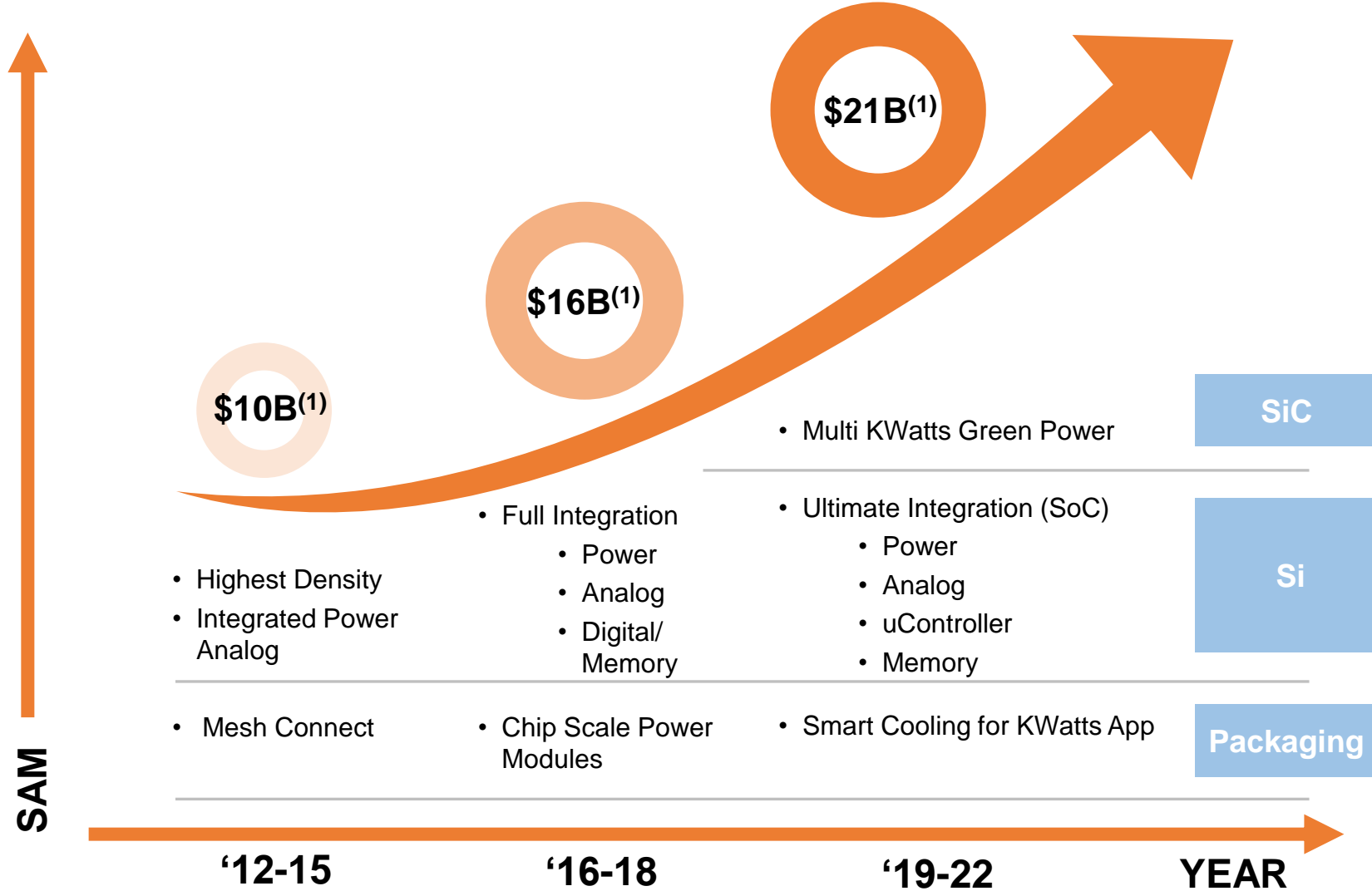

SAM Expansion

Market	2015 SAM	2018 SAM	2021 SAM
Automotive	\$4B	\$6B	\$7B
Motion Control	\$2B	\$3B	\$4B
ACDC	\$1B	\$2B	\$2B
Modules	\$1B	\$2B	\$2B
Cloud Computing (Server / Storage)	\$800M	\$1B	\$4B
Networking / Telecom	\$600M	\$1B	\$1B
Battery Management	\$600M	\$1B	\$1B
Total Market SAM	\$10B	\$16B	\$21B

MPS Global Footprint: R&D Centers and MFG Partners



EPS Growing Faster Than Revenue

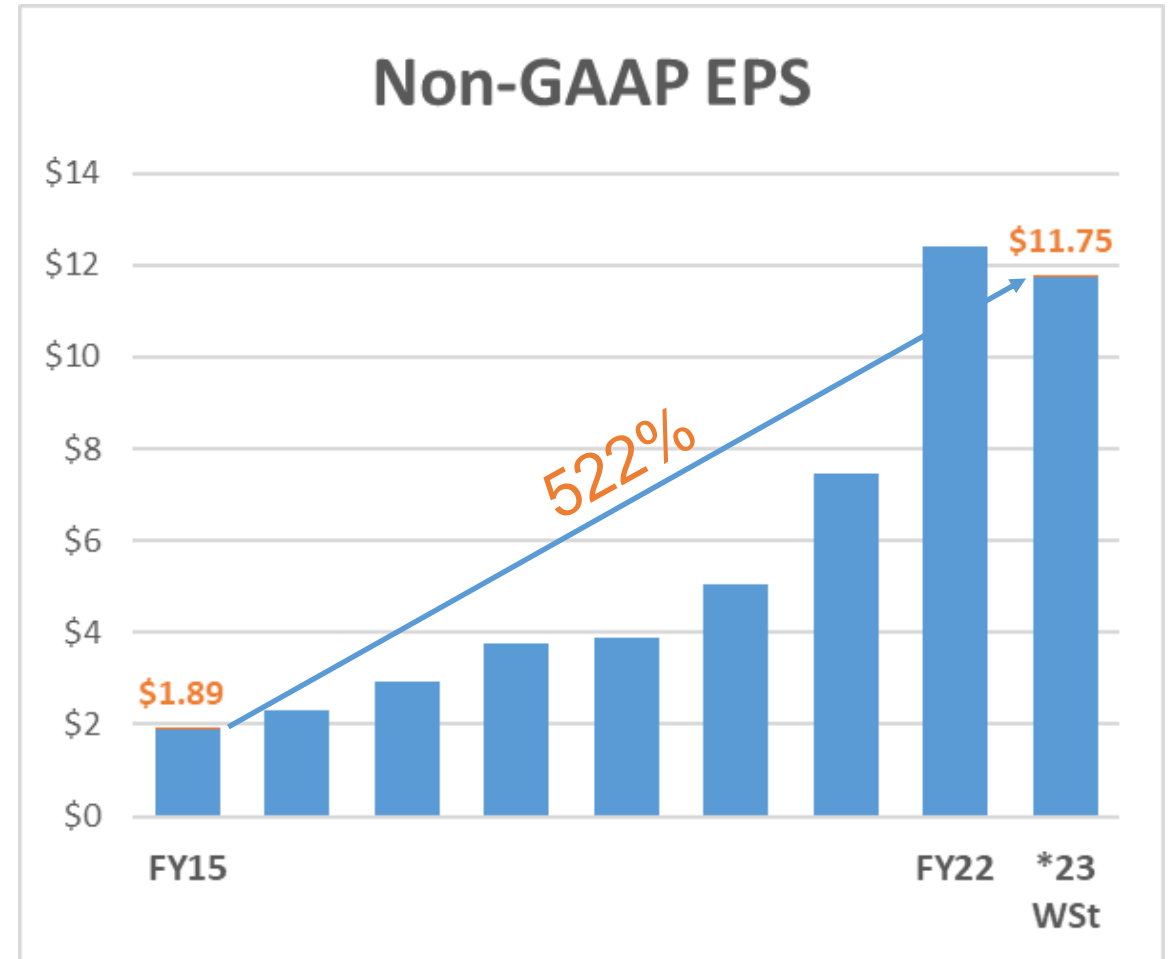
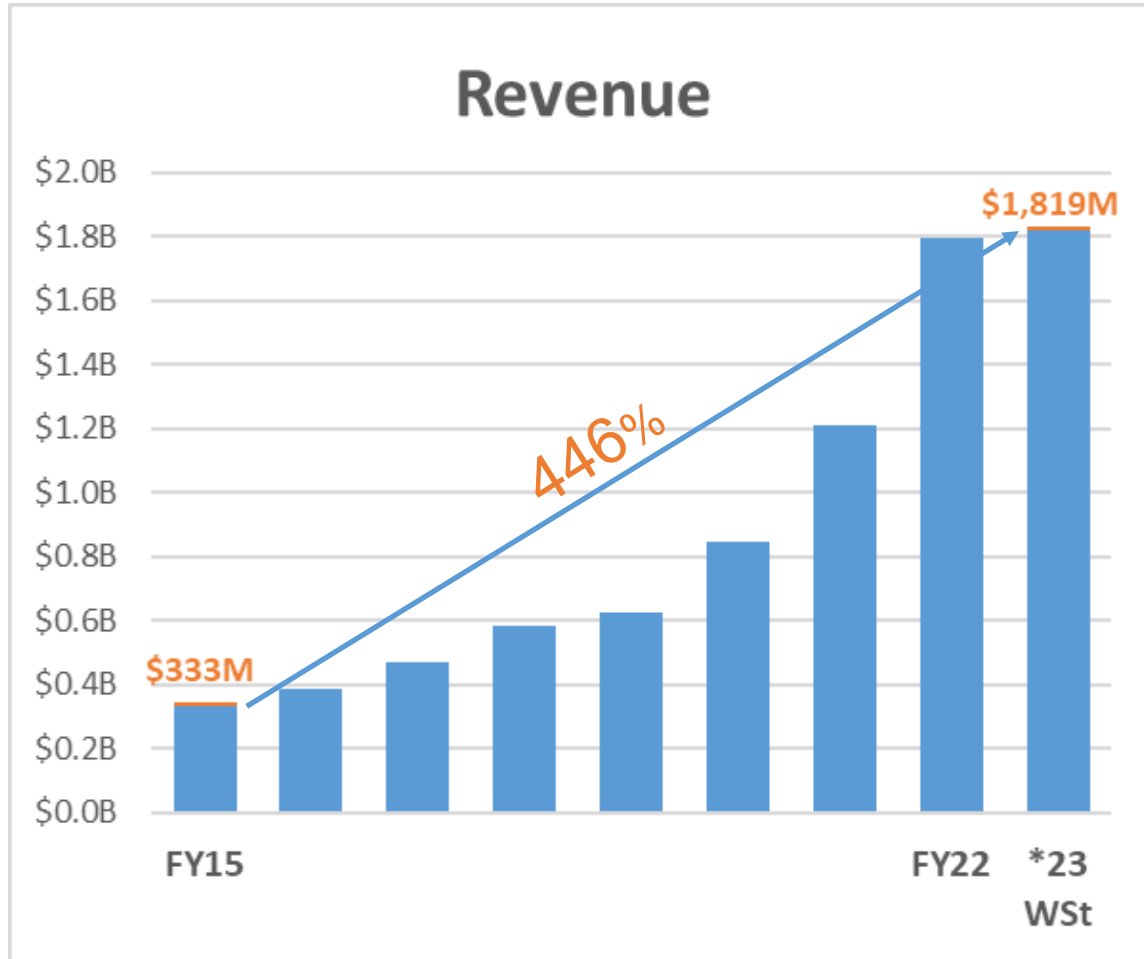

* Wall Street Forecast

Execution Against Our Commitments

Goal: Grow revenue 20% to 25%

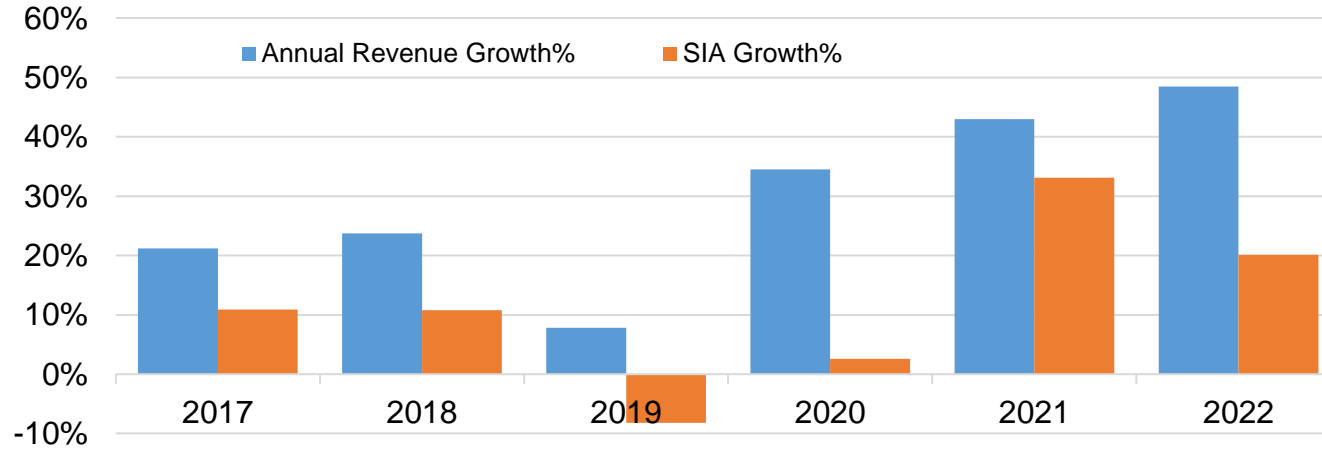

Goal: Diversify revenue from consumer

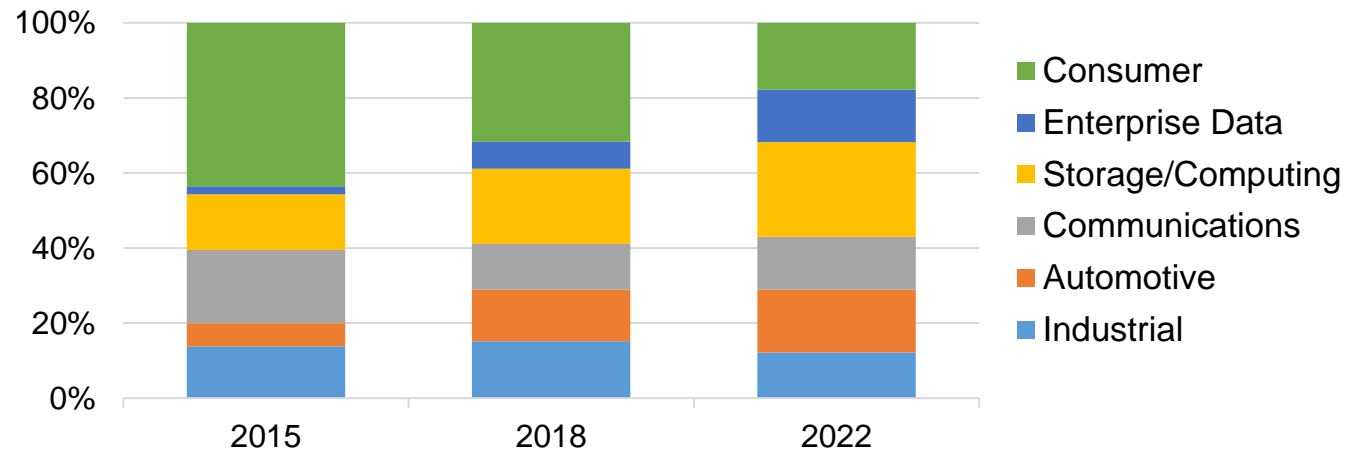

Computing

MPS

From Board Level Power to Rack and Beyond

>\$4B SAM and Rapidly Growing

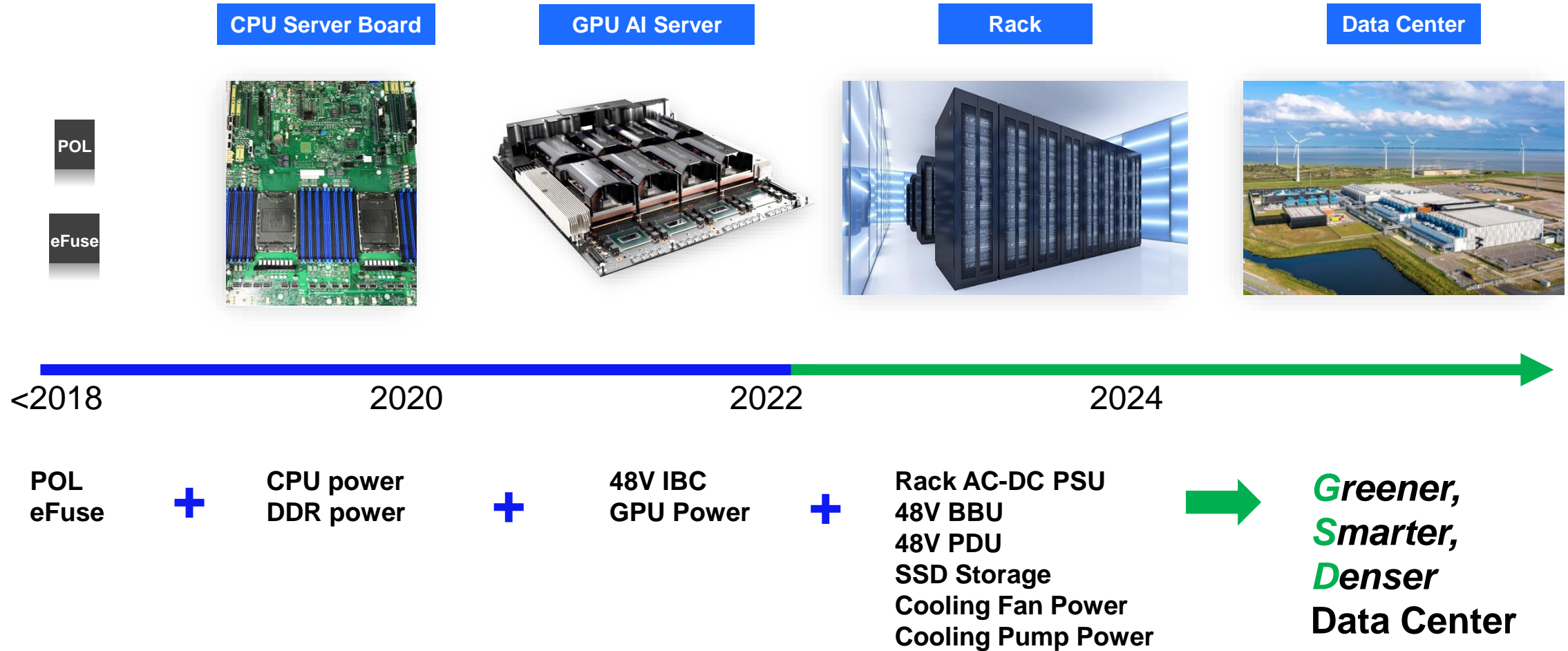

Server Board Level Power Solutions

CPU Server: \$1B SAM

\$80 MPS Content / Server

- CPU Power**
\$600M SAM
- DDR5 Memory Power**
\$280M SAM
- Point of Load**
\$60M SAM
- EFuse**
\$60M SAM

GPU Server: \$500M SAM

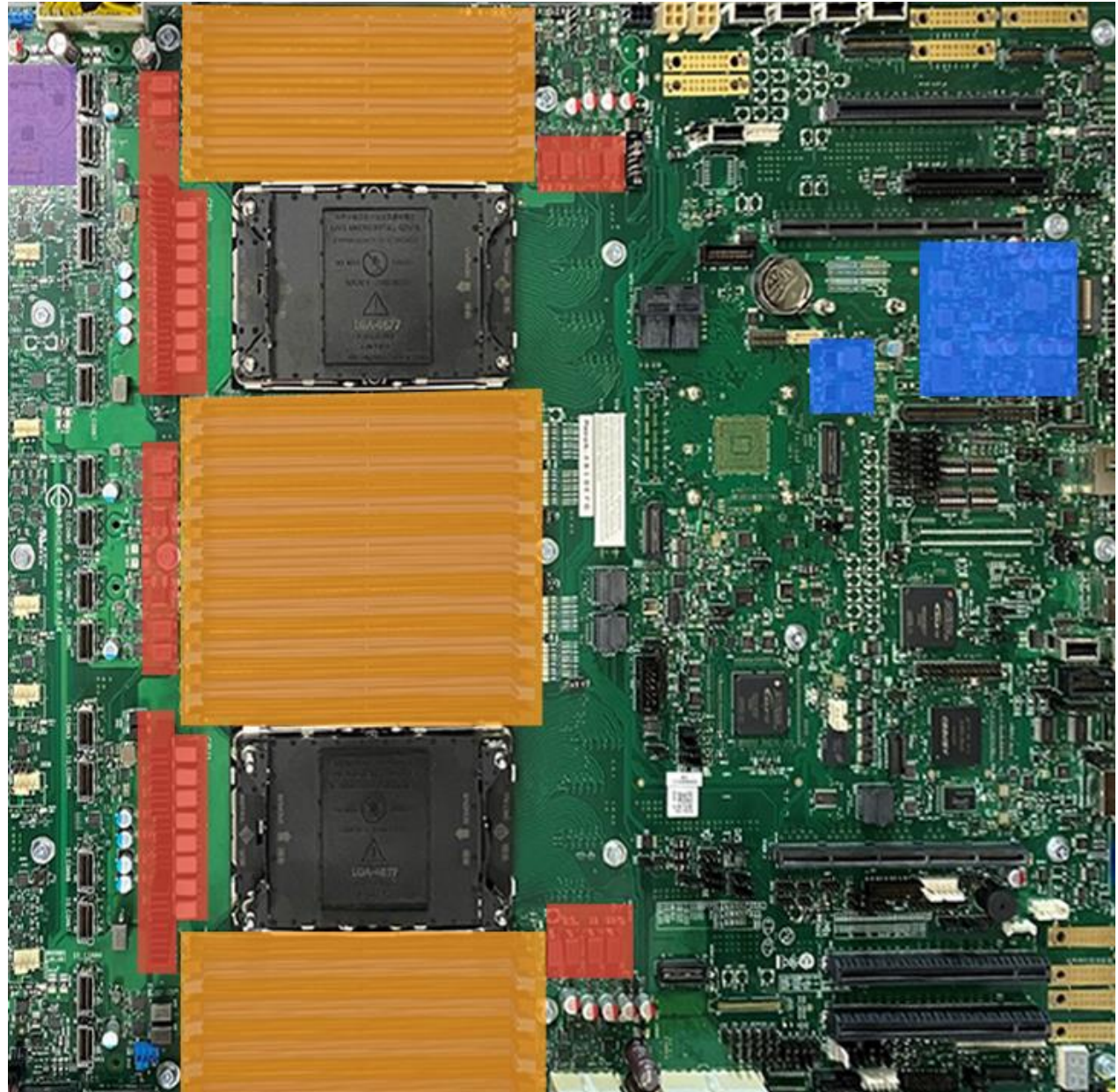

Why is MPS Winning?

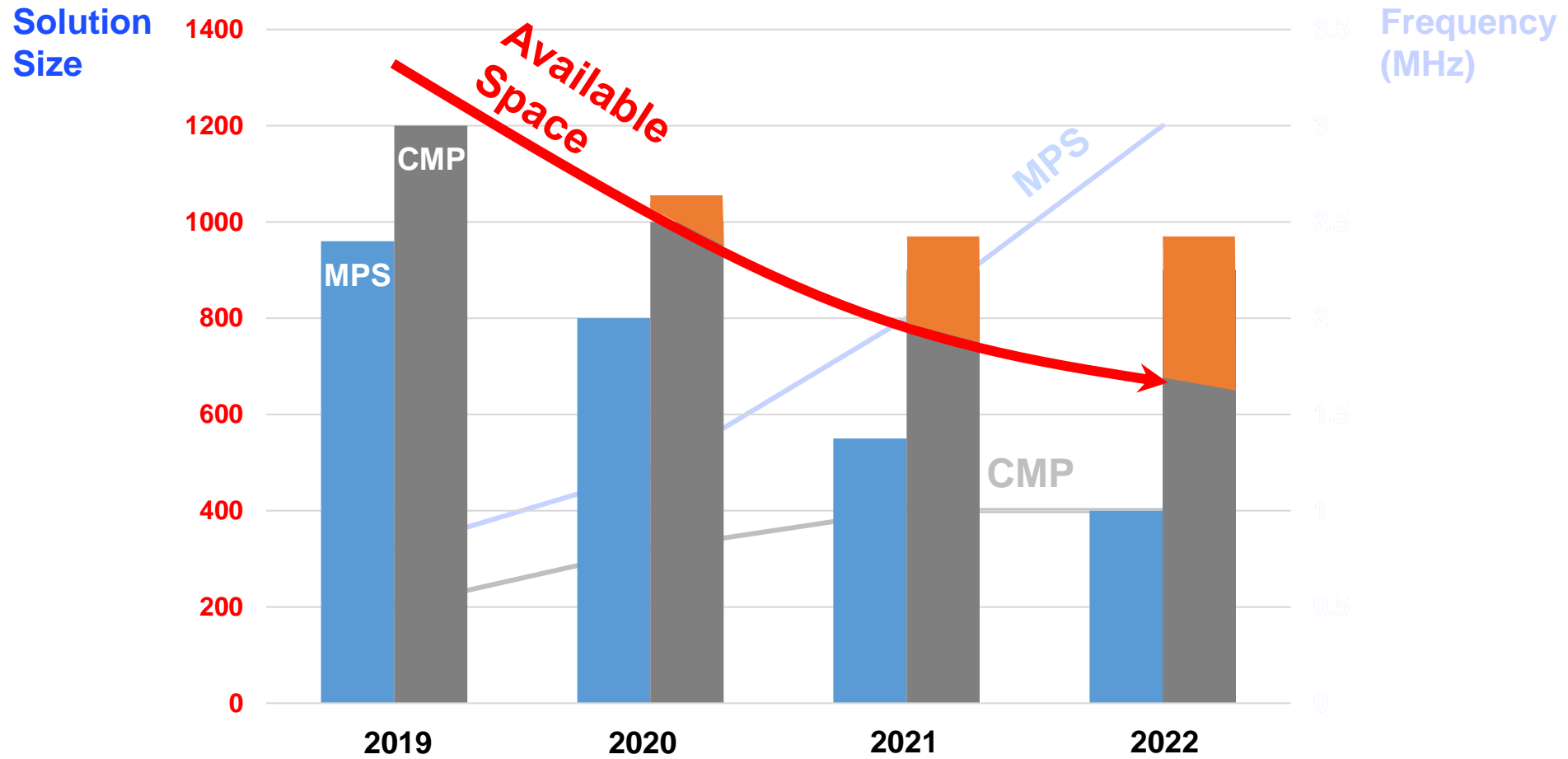

While Others Hitting Size and Frequency Boundaries, MPS Monolithic Solution Takes Off

Direct to Data Center Builders & Owners, Additional \$2B SAM

Datacenter Rack Front View

Network Switch

CPU Servers

GPU Servers

Network Storage

AC Power Supply



Rack Side View

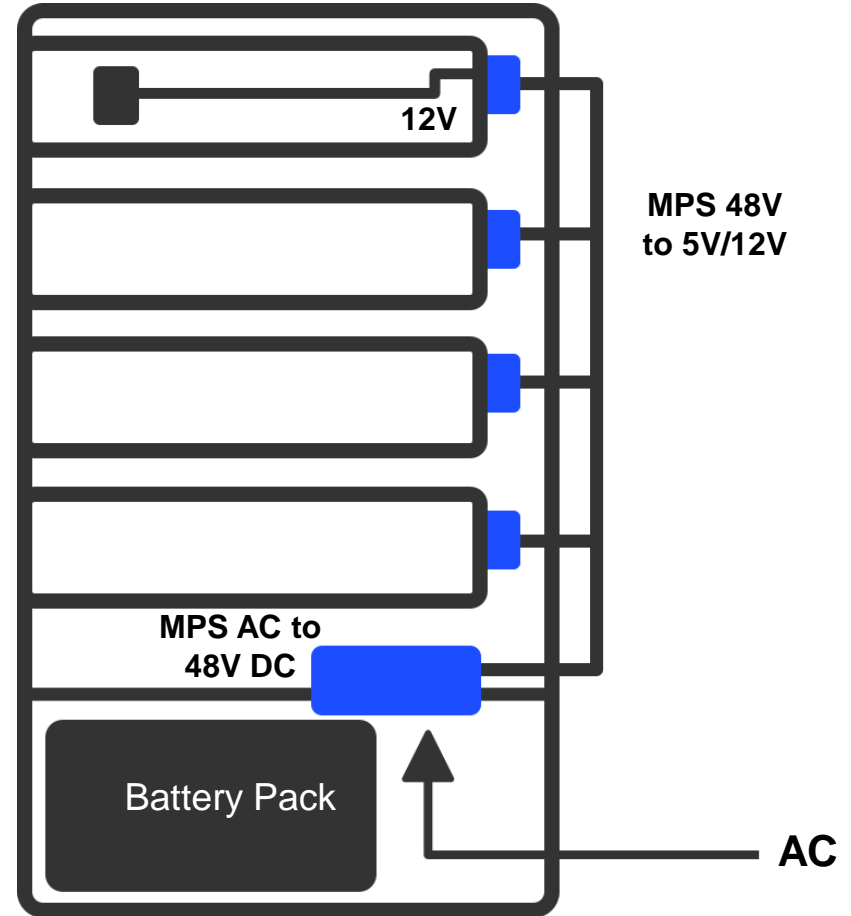
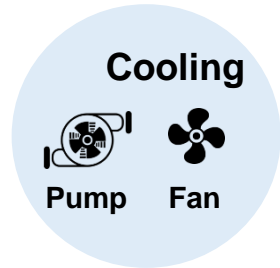

Automotive

MPS

MPS Automotive – Global and Growing

MPS Automotive Revenue

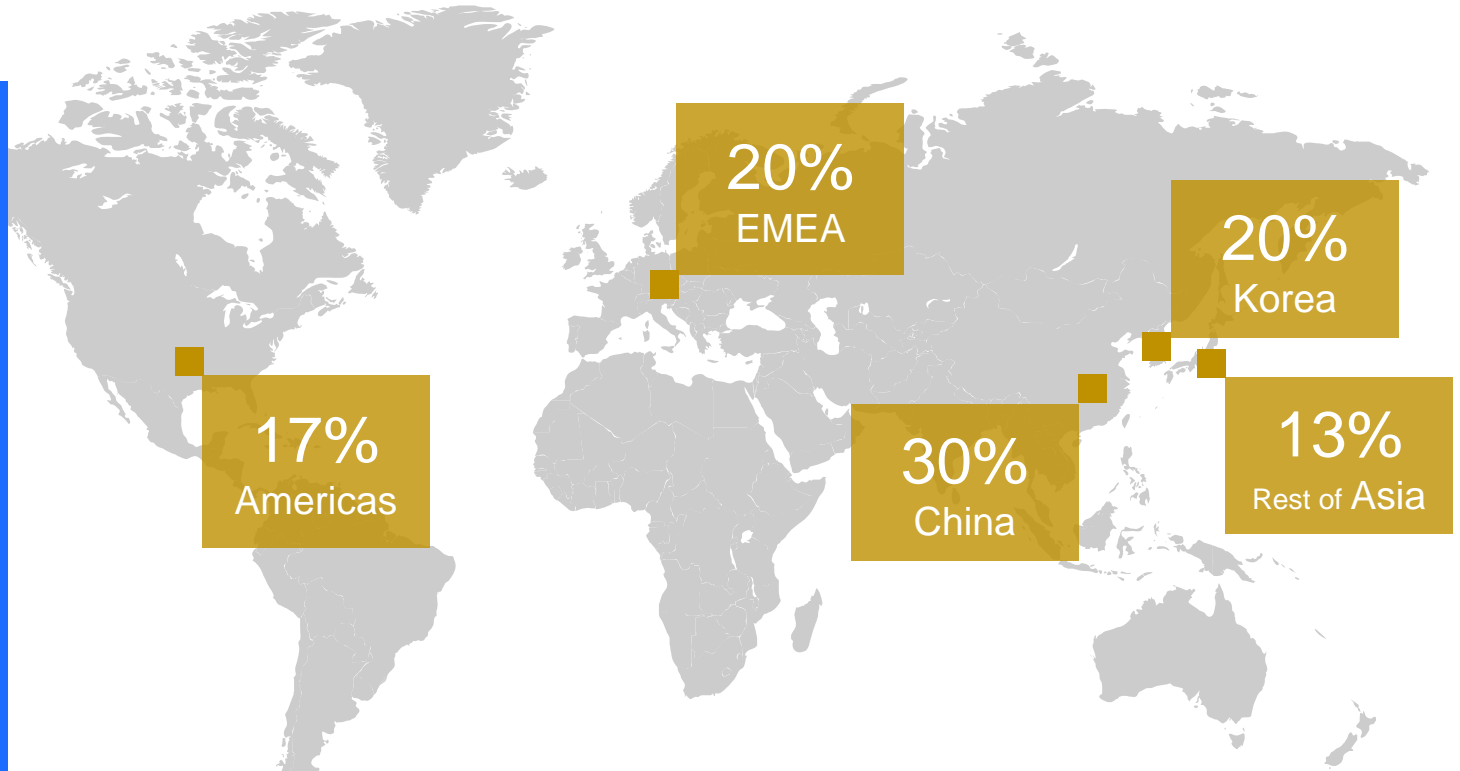
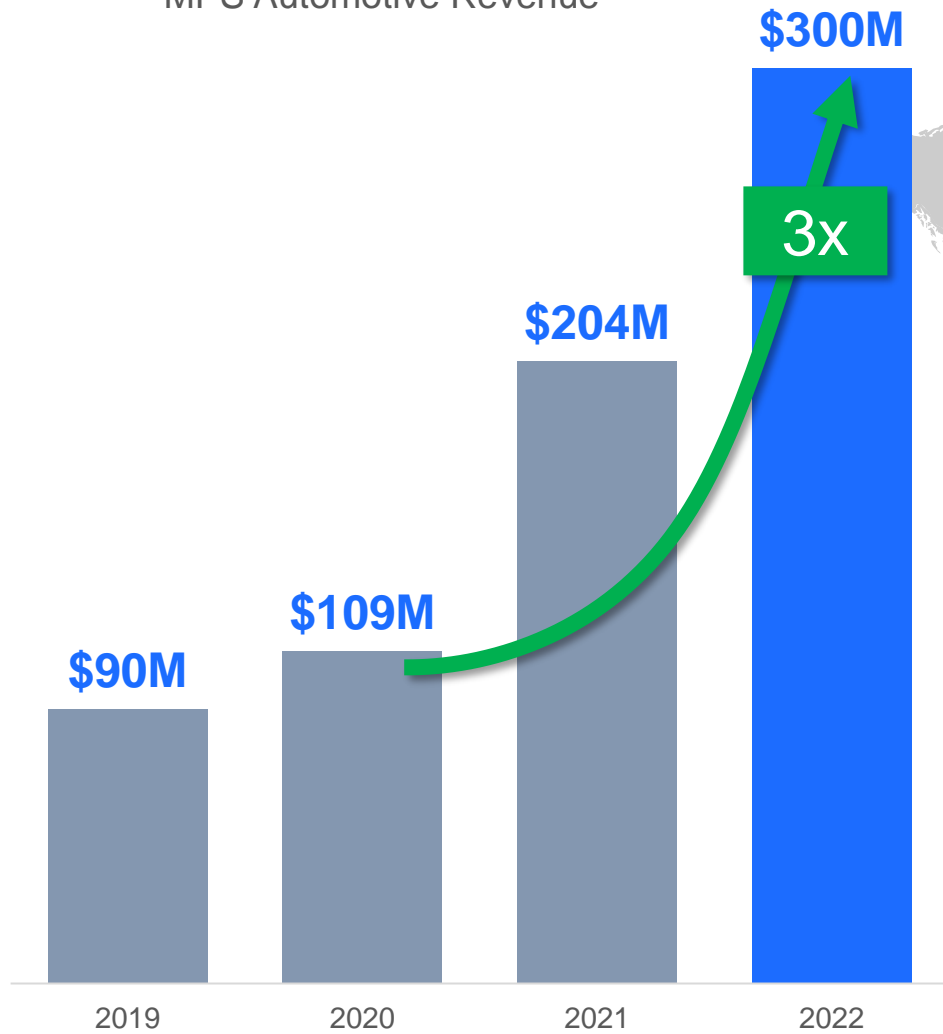

2 Billion

Auto-grade ICs shipped

17%

Total company business

12 Years

Auto industry experience

Automotive Applications Covered

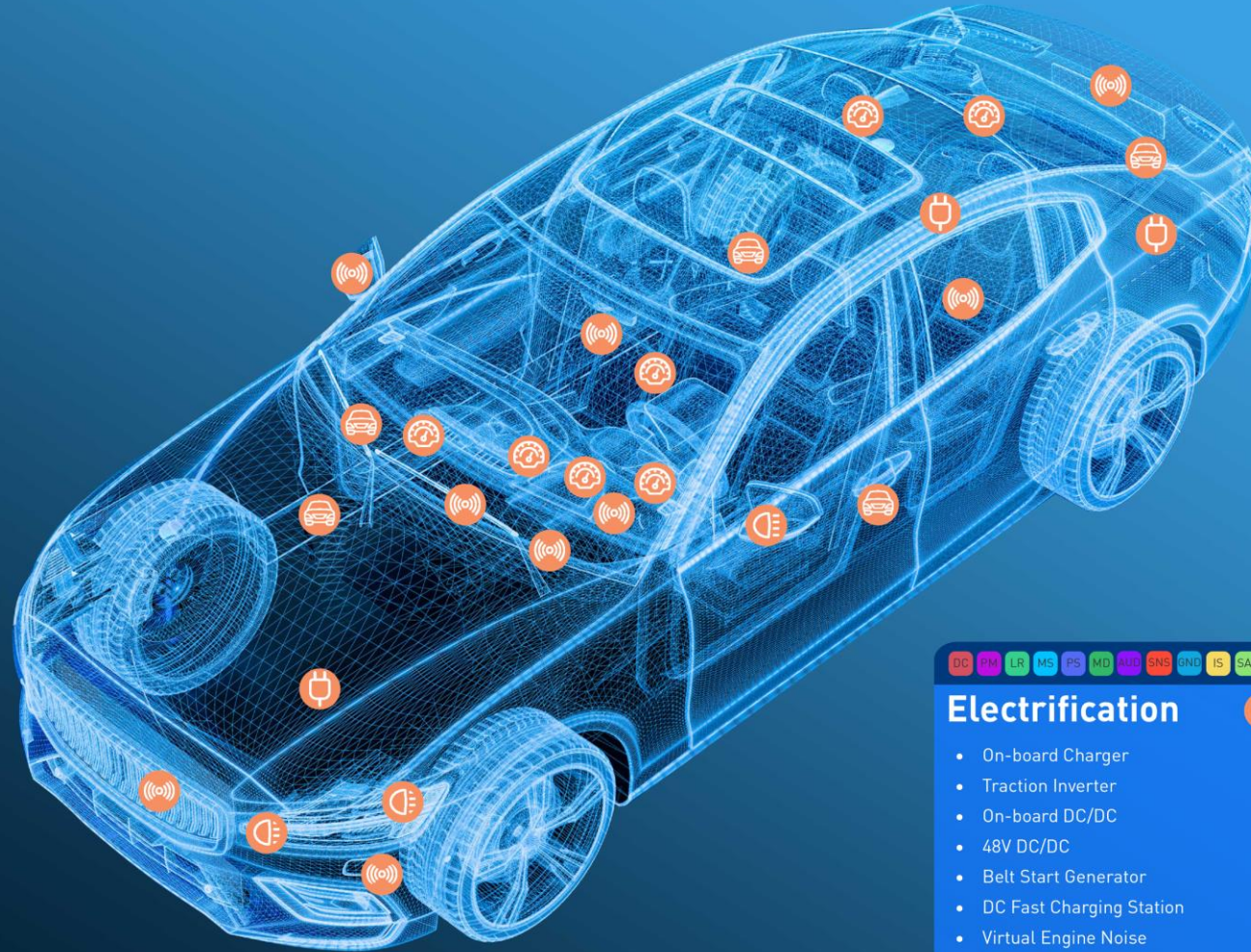

DC PM LR MS PS SAFE

ADAS

- 360° Camera
- Front Camera
- Backup Camera
- Thermal Camera
- Driver Monitoring
- Cabin Sensing
- Sensor Fusion
- Radar
- LiDAR
- Ultrasonic
- A/V Computing

DC PM LR MS PS LED USB MD MDG SNS

Digital Cockpit

- Infotainment
- E-Call
- Digital Mirror
- USB Charging
- Wireless Charging
- Telematics/V2X
- HUD
- Cluster
- Ambient Lighting

DC PM LR MS PS SNS

Body Control & Other

- Motor Modules
- Door Latch/Lock
- Keyless Entry
- Junction Box
- HVAC
- Gateway
- Liftgate
- Power Assisted Steering
- Suspension Sensor
- Wiper Motor
- Electronic Braking System
- Fluid Pumps
- Electronic Parking System
- Power Seat
- eShift

DC PM LR MS PS MD MDG SNS GND IS SAFE

Electrification

- On-board Charger
- Traction Inverter
- On-board DC/DC
- 48V DC/DC
- Belt Start Generator
- DC Fast Charging Station
- Virtual Engine Noise

DC LR MS PS LED MD SAFE

Lighting

- Daytime Running Lights
- Matrix Lights
- Fog Lights
- Headlamps
- Brake Lights/CHMSL
- Turn Indicator Lights

PRODUCT TYPES

Buck, Buck-Boost & Boost Converters

PMICs

Linear Regulators

Monitoring & Supervision

Power Switches

LED Lighting

USB & Wireless Charging

Motor Drivers

Class-D Audio

Position Sensors & Current Sensors

Isolation Solutions

GaN Driver

MPSafe™

MPS Exclusive Solutions for ADAS / Electrification

Smaller, Safer ADAS

ONLY Single Vendor



MPSafe™ High Power Controller + DrMOS
For ADAS Compute SoC

40% Smaller Footprint



MPSafe™ Camera PMIC
For L2/L3/L4 Surround View Cameras

4X Higher Power Density



30W Buck-Boost Converter
For Sensor Fusion modules

Higher Power Electrification

4X Faster Switching

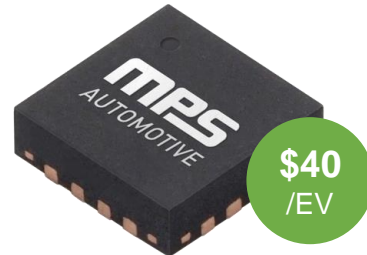

**Isolated SiC and IGBT
Power Supply**
for Traction Inverter,
On-Board Charger,
DC Fast Charging Stations

2X Smaller Footprint



**100V GaN
Gate Driver**
for 48V Mild Hybrid

2X Higher Power



**5kV Isolated SiC
Gate Driver**
for Traction Inverter

Relentless Expansion of Product Categories

New Portfolio Launches

Electrification



ADAS

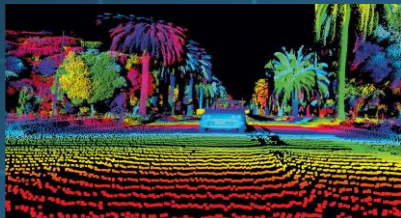

Digital Cockpit



Lighting & Body



System Safety Sequencer

GaN Driver

Hall-Effect Current Sensor

Intelligent Dynamic LED Driver

Precision Voltage Monitor

Isolated Power / Gate Drivers

ADAS SoC Compute w/ DrMOS

ADAS Camera Safety PMIC

Digital Matrix LED Manager

Safety Subsystem Module

Smart FET

High-End Premium Audio Amplifier

High Voltage Battery Monitor

SiC

New products
allow MPS to
address up to
\$400/car
additional
sockets

MPS Automotive: \$1B Wins in Pipeline



Infotainment and Telematics



Luxury OEM Infotainment



Infotainment



Digital Cluster



Android Module



Telematics



ADAS Domain Controller



Triple Forward Camera



Collision Avoidance Domain Master



Backup Camera



Surround View Monitor



Near-Range Camera



Advanced Backup Camera



Dynamic Taillight



Rear Lamp



Fog Lamp



Front Lamp



Daytime Running Light



Daytime Running Light



eTurbo



Hybrid Battery Power



DC Fast Charger



Onboard Charger



48V BMS

Data Com

MPS

Data Com / Security – \$4B SAM

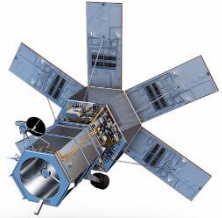

Satellite & Ground Receiver: Dish + Wifi Router

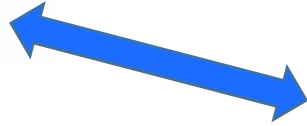

DSL/VDSL & Security Systems

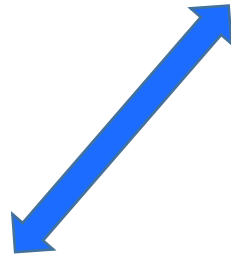
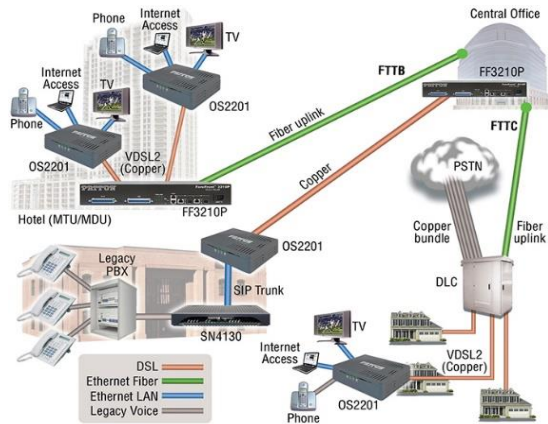

Enterprise WiFi & Security Systems

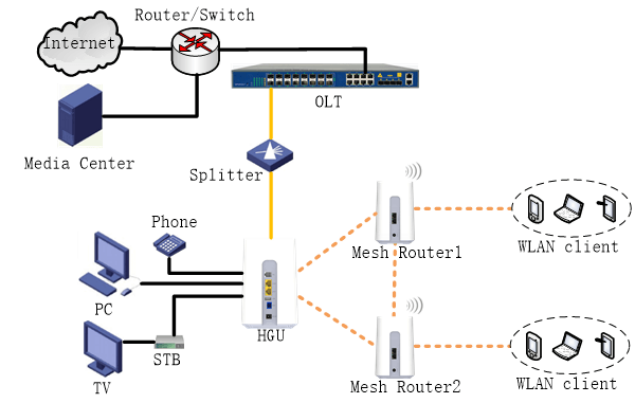

Clean Energy & Storage

MPS

\$2B SAM Opportunities in Carbon Reduction: Clean Energy and Storage

Over \$150M design wins
25+ products in development

Geothermal
In development

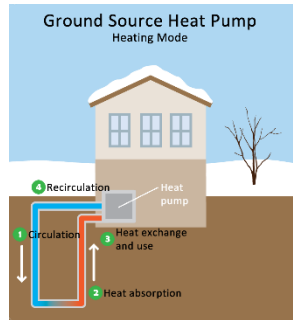

Solar Inverter



Smart meter



Wind Farm
In development



Megawatt Battery Storage



Home Battery Storage



Other Revenue

MPS

Over \$3B SAM

Super Computer /
Big Data



5G Base Station



Semi-equipment



Inspection Robot



Co-Robot



UltraSound



Home appliances



Point of sale



USB PD



RV&Boat



X-Ray



**Well Positioned with Excellent
Financial Strength**

MPS

Consistent Revenue Growth & Shareholders' Return

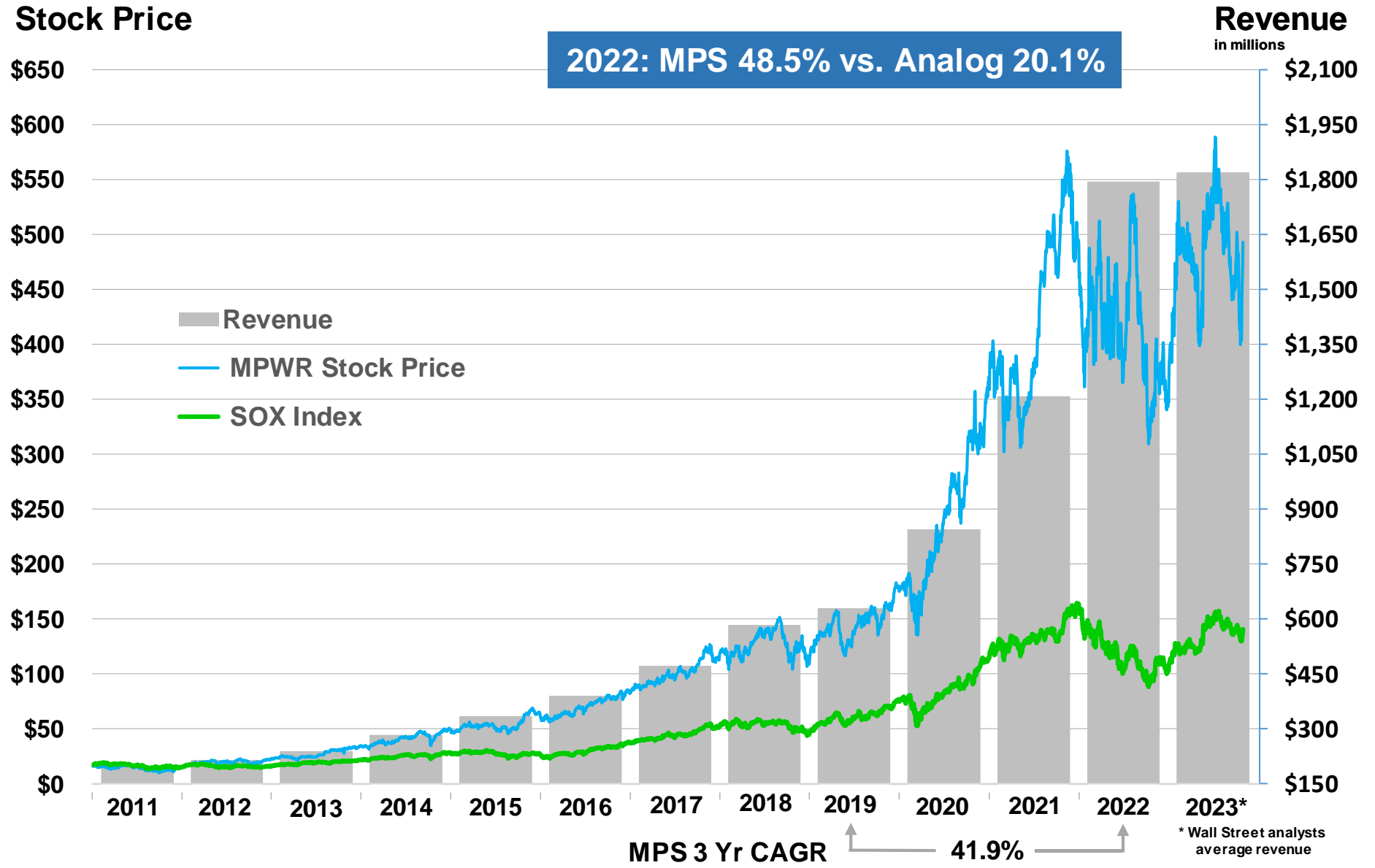

Capital Allocation – 47% of Cash Returned to Shareholders

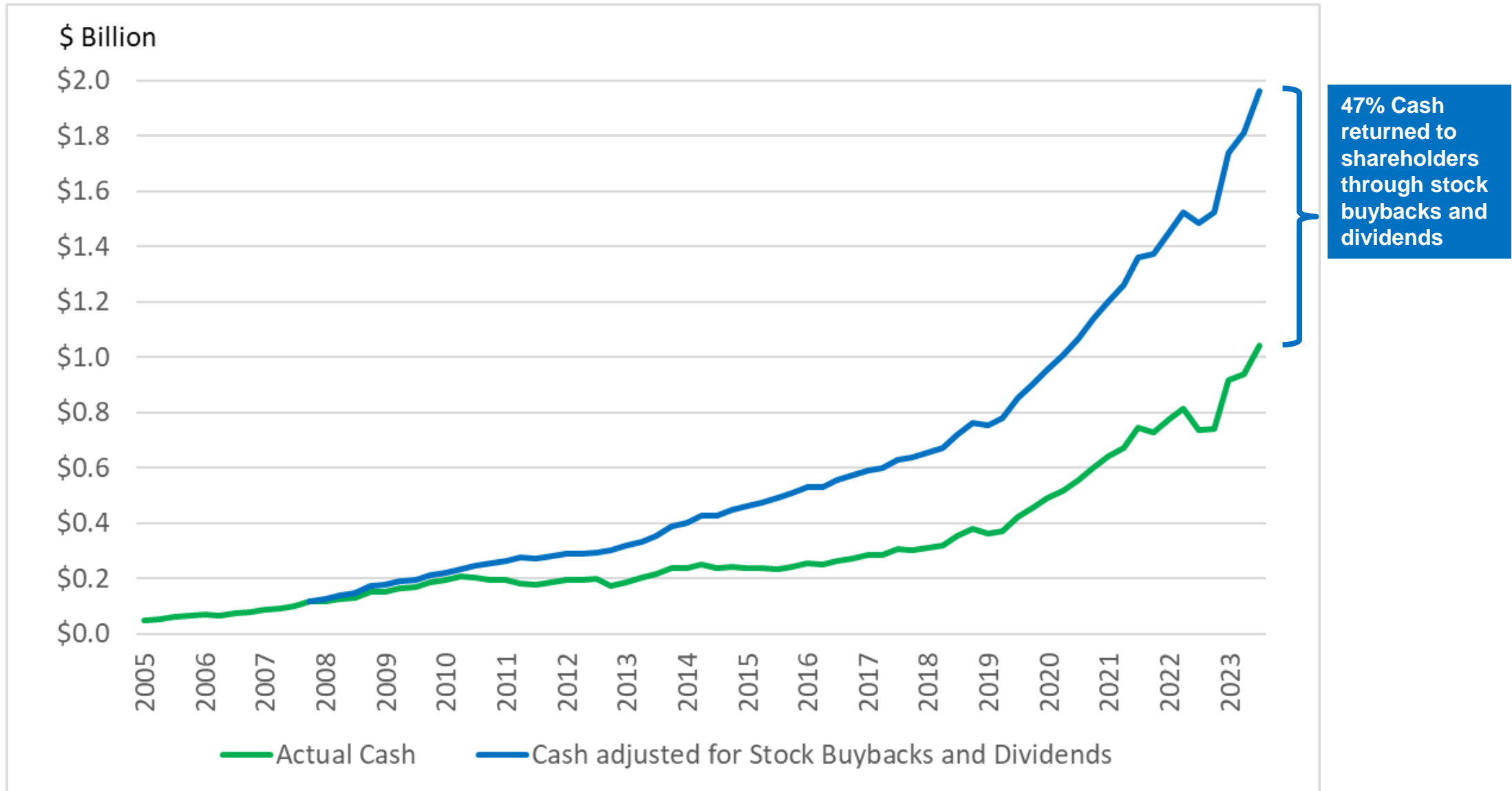

MPS grows regardless of the market environment

MPS

Q&A